

# USER MANUAL

**MyALARM3 CLOUD W-AIR**

**MyALARM3 CLOUD 2G**

**MyALARM3 CLOUD 4G**



**SENECA S.r.l.**

**Via Austria 26 – 35127 – Z.I. - PADOVA (PD) - ITALY**

**Tel. +39 049.8705355 Fax +39 049.8706287**

**[www.seneca.it](http://www.seneca.it)**



**ORIGINAL INSTRUCTIONS**

## CAUTION

SENECA does not guarantee that all specifications and/or aspects of the product and firmware, included in them, will meet the requirements of the actual final application even if the product referred to in this documentation is in compliance with the technological state of the art.

The user assumes full responsibility and/or risk with regard to the configuration of the product to achieve the intended results in relation to the specific installation and/or end application.

SENECA may, with prior agreement, provide consultancy services for the successful completion of the final application, but under no circumstances can it be held responsible for its proper functioning.

The SENECA product is an advanced product, the operation of which is specified in the technical documentation supplied with the product itself and/or can be downloaded, if desired prior to purchase, from the [www.seneca.it](http://www.seneca.it) website.

SENECA has a policy of continuous development and accordingly reserves the right to make and/or introduce - without prior notice - changes and/or improvements to any product described in this documentation.

The product described in this documentation may solely and exclusively be used by personnel qualified for the specific activity and in accordance with the relevant technical documentation, with particular attention being paid to the safety instructions.

Qualified personnel means personnel who, on the basis of their training, competence and experience, are able to identify risks and avoid potential hazards that could occur during the use of this product.

SENECA products may only be used for the applications and in the manner described in the technical documentation relating to the products themselves.

To ensure proper operation and prevent the occurrence of malfunctions, the transport, storage, installation, assembly, maintenance of SENECA products must comply with the safety instructions and environmental conditions specified in this documentation.

SENECA's liability in relation to its products is governed by the general conditions of sale, which can be downloaded from [www.seneca.it](http://www.seneca.it).

Neither SENECA nor its employees, within the limits of applicable law, will in any case be liable for any lost profits and/or sales, loss of data and/or information, higher costs incurred for goods and/or replacement services, damage to property and/or persons, interruption of activities and/or provision of services, any direct, indirect, incidental, pecuniary and non-pecuniary, consequential damages in any way caused and/or caused, due to negligence, carelessness, incompetence and/or other liabilities arising from the installation, use and/or inability to use the product.

### CONTACT US

Technical support	<a href="mailto:supporto@seneca.it">supporto@seneca.it</a>
Product information	<a href="mailto:commerciale@seneca.it">commerciale@seneca.it</a>

This document is the property of SENECA srl.  
Copies and reproduction are prohibited unless authorised.

## Document revisions

DATE	REVISION	NOTES	AUTHOR
16/04/2024	0	First issue	MM AZ
29/07/2024	1	Improved AP – STATION passage chapter	MM
15/10/2024	2	Added changes for new firmware 1.0.0.53	MM
07/11/2024	3	Added additional information on first startup	MM
07/01/2025	4	Added chapter CHANGING ROUTER OR WIFI PARAMETERS Small changes and fixes Removed chapter on switching from Access Point / Station Mode	MM
18/03/2025	5	Added new primary/secondary AP function Added QR code for AP access Modified the main menu Added watchdog parameter	MM
04/07/2025	6	Added changes for firmware revision 1.0.1.73: The access point mode is now protected with a default password.	MM
28/07/2025	7	Added changes for firmware revision 2.0.1.5: Replaced update binary name from fwota.bin to fwota2.bin First start procedure changed (now the AP password is requested at the end)	MM
02/02/2026	8	Added My3 Cloud 4G and 2G products	MM
29/05/2026	9	Integration of the procedure related to the SD Card Content Generator software	AC

**TABLE OF CONTENTS**

<b>1.</b>	<b>PRELIMINARY WARNINGS .....</b>	<b>6</b>
<b>2.</b>	<b>PRODUCT DESCRIPTION .....</b>	<b>7</b>
2.1.	DIFFERENZA TRA I MODELLI .....	7
<b>3.</b>	<b>CONTROL UNIT INSTALLATION .....</b>	<b>8</b>
3.1.	INSTALLATION OF THE MYALARM3 CLOUD W-AIR MODEL .....	8
3.1.1.	CONTROL UNIT POWER ON AND POWER OFF .....	9
3.1.2.	FIRST STARTUP PROCEDURE .....	10
3.2.	INSTALLATION OF THE MYALARM3 CLOUD 4G AND MYALARM3 CLOUD 2G MODELS .....	15
3.2.1.	CONTROL UNIT POWER ON AND POWER OFF .....	16
3.2.2.	FIRST POWER-ON PROCEDURE .....	17
3.3.	ELECTRICAL CONNECTIONS .....	19
<b>4.</b>	<b>DISPLAY .....</b>	<b>20</b>
4.1.	MAIN MENU .....	20
4.1.1.	MAIN MENU ITEMS .....	21
4.1.2.	CHANGING ROUTER OR WIFI PARAMETERS (W-AIR MODEL ONLY) .....	22
4.2.	SCREEN CHANGE AND CONTEXTUAL MENUS .....	22
4.2.1.	MAIN SCREEN .....	23
4.2.2.	TEMPERATURE MEASUREMENT SCREEN .....	23
4.2.3.	ANALOG INPUT 1 AND 2 SCREENS .....	23
4.2.4.	TOTALISER SCREENS 1, 2, 3 AND 4 .....	23
4.2.5.	DATE AND TIME SCREEN .....	24
4.2.6.	CONTROL UNIT STATUS SCREEN .....	25
<b>5.</b>	<b>ACTIVATION AND MANAGEMENT OF THE CLOUD SERVICE .....</b>	<b>26</b>
5.1.	USER ACCOUNT (GUEST) .....	26
5.2.	EXAMPLES .....	27
5.2.1.	THREE "OWNER ACCOUNTS" ONLY MANAGE THEIR OWN CONTROL UNIT: .....	27
5.2.2.	AN "OWNER ACCOUNT" AND TWO "USER ACCOUNTS" MANAGE THE SAME CONTROL UNIT: .....	28
5.2.3.	CROSS INVITATIONS: .....	29
5.3.	ACCOUNT ACTIVATION .....	29
5.3.1.	ACTIVATING THE ACCOUNT FROM THE MYALARM3 CLOUD APP .....	30
5.3.2.	ACTIVATION OF THE ACCOUNT FROM THE WEB BROWSER .....	30
5.4.	INVITE OTHER ACCOUNTS TO CONTROL YOUR CONTROL UNIT .....	31
5.5.	CANCELLATION OF THE OWNER ACCOUNT .....	31
5.6.	CHANGE OF OWNERSHIP OF THE CONTROL UNIT FROM ONE OWNER ACCOUNT TO ANOTHER (MOVING FROM INSTALLER TO CUSTOMER) .....	32
5.7.	CLOUD SERVICE RENEWAL .....	33
5.8.	REVOKE AN INVITATION TO A GUEST ACCOUNT FROM AN OWNER ACCOUNT .....	33
5.9.	DELETE THE INVITATION RECEIVED .....	33
<b>6.</b>	<b>INSTALLATION OF THE EXTERNAL NTC TEMPERATURE PROBE .....</b>	<b>34</b>

---

<b>7.</b>	<b>MANUAL FIRMWARE UPDATE PROCEDURE VIA MICROSD CARD .....</b>	<b>35</b>
7.1.	MYALARM 3 CLOUD W-AIR MODEL .....	35
7.2.	MYALARM 3 CLOUD 2G MODEL .....	35
7.3.	MYALARM 3 CLOUD 4G MODEL .....	35
<b>8.</b>	<b>ENABLING NOTIFICATIONS ON ANDROID 11 OR HIGHER DEVICES.....</b>	<b>36</b>
<b>9.</b>	<b>CUSTOM APN CONFIGURATION (MYALARM 3 CLOUD 2G AND 4G MODELS ONLY).....</b>	<b>37</b>
<b>10.</b>	<b>ENABLING THE DEBUG LOG ON THE SD CARD (MYALARM3 CLOUD 2G AND 4G MODELS ONLY).....</b>	<b>38</b>
<b>11.</b>	<b>TROUBLESHOOTING.....</b>	<b>39</b>

## 1. PRELIMINARY WARNINGS

### **ATTENTION!**

This user manual extends the information from the installation manual to the configuration of the device. Use the installation manual for more information.

### **ATTENTION!**

- Do not apply different voltages or higher voltages than indicated between terminals, or between any terminal and earth (voltages greater than 50Vdc)
- Do not use the MyAlarm3 Cloud control unit if damaged, or if signs of possible damage are visible on it.
  - Do not remove the internal battery.
  - Do not use the MyAlarm3 Cloud control unit if it runs abnormally.
  - Do not touch the control unit terminals during use
  - For a correct use, use the cables supplied.
- Make sure the internal battery is charged if you intend to use the MyAlarm3 Cloud control unit without power.
  - Use the MyAlarm3 Cloud control unit as described in this manual.
- Before each use, refer to the electrical connections shown in the manual.

## 2. PRODUCT DESCRIPTION

MyAlarm3 is a monitoring system consisting of an intelligent control unit for remote control of homes, systems, machinery and unattended instruments.

The system is based on a Cloud platform offered by SENECA S.R.L. ( <https://cloud.seneca.it/> ).

The Cloud service subscription is included with the purchase of the product.

The SENECA Cloud service is free for 12 months from the product activation date for the My Alarm 3 Cloud 2G and 4G models, and is free for 24 months for the My Alarm 3 Cloud W-AIR model.

For information and pricing regarding service renewal, please visit the product page on the Seneca website.

### 2.1. DIFFERENZA TRA I MODELLI

The difference between the models is the method of connecting to the internet:

<b>MODEL</b>	<b>CLOUD CONNECTION</b>
MY ALARM 3 CLOUD W-AIR	WI-FI
MY ALARM 3 CLOUD 2G	2G cellular network
MY ALARM 3 CLOUD 4G	4G and 2G cellular networks

Using Seneca's MyALARM3 Cloud app (available for both Android and iOS), you can:

View the real-time status of digital inputs

View the real-time status of analog inputs

View the real-time status of alarms

Control digital outputs

Receive alarms

Configure the device and alarms

Set temperature thresholds, actions, and event-based alarms for room climate control phases

Create and manage accounts for users invited to the service

### 3. CONTROL UNIT INSTALLATION

#### 3.1. INSTALLATION OF THE MYALARM3 CLOUD W-AIR MODEL



## **ATTENTION!**

**FOR CORRECT OPERATION OF THE CONTROL UNIT IT IS NECESSARY THAT THE SD CARD SUPPLIED BE ALWAYS INSERTED!**



## **ATTENTION!**

**IT IS NECESSARY TO HAVE A WIFI ROUTER CONNECTED TO THE INTERNET FOR THE CONTROL UNIT TO WORK**

The control unit allows you to manage alarms and measurements remotely in real time via the Seneca cloud and the APP installed on one or more smartphones.

To do this you need to have an Internet connection and a WIFI router to which you will connect the device.

The initial configuration for connection to the WIFI router takes place locally, but subsequent configurations of the device take place remotely via the APP.

**3.1.1. CONTROL UNIT POWER ON AND POWER OFF** **ATTENTION!**

THE NEWLY PURCHASED CONTROL UNIT IS IN "SHIPPING MODE" IN ORDER TO PRESERVE THE BATTERY.

TO START THE CONTROL UNIT FOR THE FIRST TIME IT IS NECESSARY TO USE THE SUPPLIED POWER SUPPLY AND TO POWER THE DEVICE VIA THE ELECTRICITY MAINS.

FOR THE FIRST IGNITION, PLEASE REFER TO THE "FIRST STARTUP PROCEDURE" DESCRIBED IN THE NEXT CHAPTER

 **ATTENTION!**

IT IS SWITCHED OFF BY HOLDING THE "PWR" BUTTON PRESSED UNTIL THE MAIN MENU APPEARS.

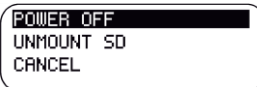

IF NOT SELECTED, SELECT THE "POWER OFF" ITEM WITH THE "SCR" BUTTON AND CONFIRM SWITCHING OFF WITH "PWR"

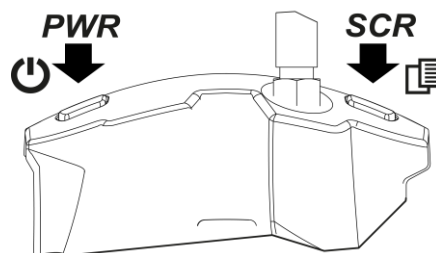

**3.1.2. FIRST STARTUP PROCEDURE**

Download and install the “MyALARM3 Cloud by Seneca” APP on your mobile phone:



- 1) Insert the provided microSD card (if not already inserted) and install the antenna:

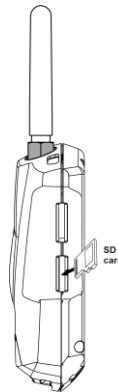

- 2) Power supply: for the first start-up use the supplied power supply and follow the next image for the wiring. If this is the first time you turn it on, you will need to insert the power supply into the socket and then press the "PWR" button:

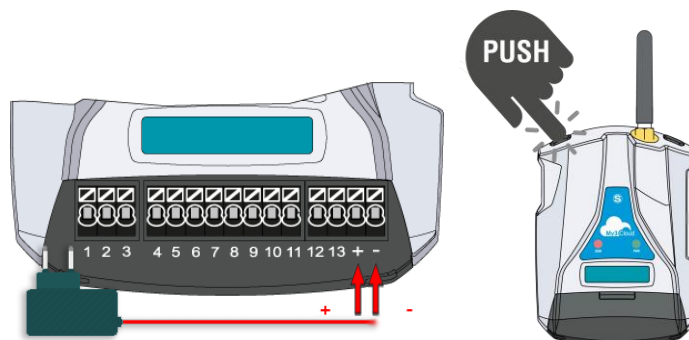

- 3) Start-up: At this point the control unit turns on and the writing "WIFI ACCESS POINT" will appear on the display, the "NET" LED flashes continuously and the control unit is therefore ready to accept the WIFI connection of a smartphone for the first configuration.



- 4) Now switch to a device with a web browser (PC, phone, tablet etc.)

If the device already has a WIFI network configured with internet access, the automatic reconnection option must be eliminated (otherwise the device will connect to this network instead of that of the MyALARM3 Cloud W-AIR control unit):

For example, on Windows PCs:

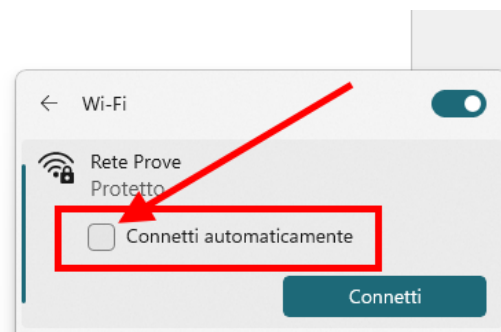

On Android devices:

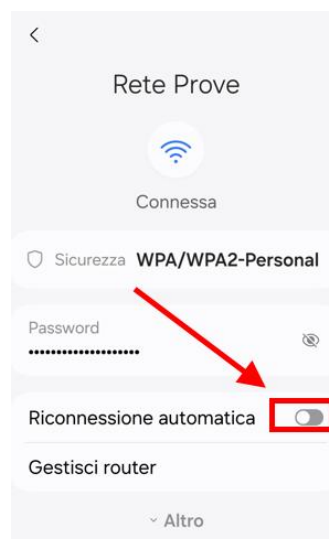

Search and connect to the WIFI network created by the control unit, the name is something like:

MYA\_C8F981xxxxxx

(where xxxxxxxxxxxx is the unique MAC address of the control unit)

Enter the default password:

87654321

Then open a web browser and enter the address below or scan the following QR code using your mobile phone:

<http://192.168.4.1>



- 5) You can now manually enter the router's Wi-Fi network to connect to the internet, or search for it automatically. It is possible to insert up to two different Wifi routers (primary and secondary), in case of failure of connection to the primary the control unit will connect to the secondary. If you want to use a single wifi router leave the secondary empty.

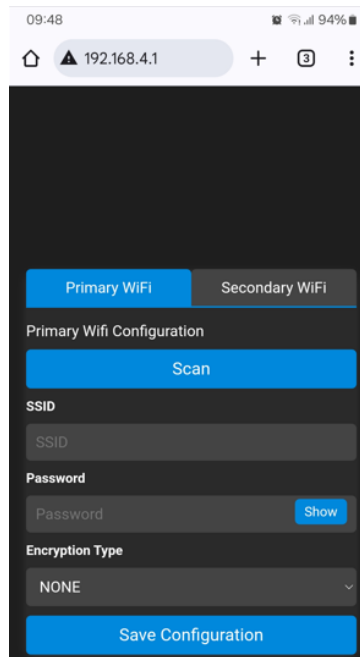

- 6) To search for the router's wifi network to which the control unit will connect, press the "SCAN" button to start the network scan process:

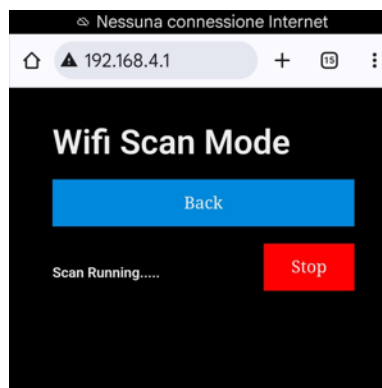

At the end, the wifi networks of the routers in the area are displayed:

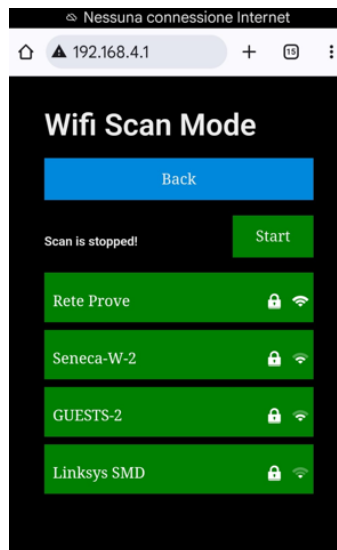

Now choose the router network to which you want to connect the control unit:

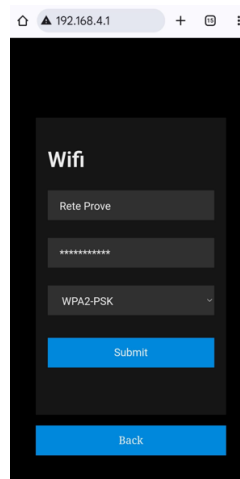

- 7) It is now possible to enter the router WIFI network password to which the control unit will connect.
- 8) After this operation, the new password is required for a possible future new access to Access Point mode (this password will replace the default one: 87654321).
- 9) At this point the control unit will restart in station mode by connecting to the WIFI router configured. If the connection parameters have been entered correctly, the "NET" LED is on steadily, flashing only when sending data. Furthermore, the WIFI signal level appears on the main page:

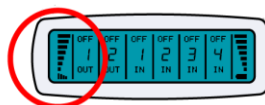

You can now proceed to the account activation procedure.

 **ATTENTION!**

THE WIFI ROUTER TO WHICH THE CONTROL UNIT WILL CONNECT MUST BE CONNECTED TO THE INTERNET

### 3.2. INSTALLATION OF THE MYALARM3 CLOUD 4G AND MYALARM3 CLOUD 2G MODELS

 **ATTENTION!**

TO ENSURE PROPER OPERATION OF THE CONTROL UNIT, THE SUPPLIED SD CARD MUST ALWAYS BE INSERTED!

 **ATTENTION!**

YOU MUST HAVE AN ACTIVATED SIM CARD TO CONNECT TO THE INTERNET

The control unit allows you to manage alarms and measurements in real time remotely via the Seneca cloud and the app installed on one or more smartphones.

To do this, you need a data SIM card capable of connecting to the internet.

Subsequent device configurations are performed remotely via the app.

**3.2.1. CONTROL UNIT POWER ON AND POWER OFF** **ATTENTION!**

THE CONTROL UNIT YOU HAVE JUST PURCHASED IS IN “SHIPPING MODE” TO CONSERVE BATTERY POWER.

TO START THE CONTROL UNIT FOR THE FIRST TIME, YOU MUST USE THE SUPPLIED POWER ADAPTER AND CONNECT THE DEVICE TO THE MAINS POWER SUPPLY.

FOR THE FIRST START-UP, REFER TO THE “FIRST START-UP PROCEDURE” DESCRIBED IN THE NEXT CHAPTER

 **ATTENTION!**

TO TURN OFF THE DEVICE, HOLD DOWN THE “PWR” BUTTON UNTIL THE MAIN MENU APPEARS.

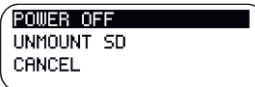

IF NOT SELECTED, USE THE “SCR” BUTTON TO SELECT “POWER OFF” AND CONFIRM SHUTDOWN WITH “PWR”

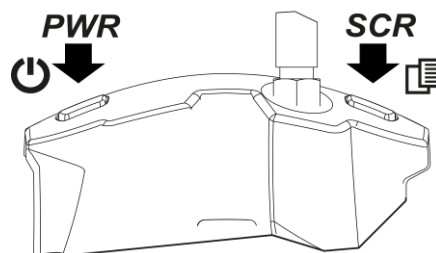

**3.2.2. FIRST POWER-ON PROCEDURE**

Download and install the “MyALARM3 Cloud by Seneca” app on your phone:



- 1) Insert the supplied microSD card (if it is not already inserted) and the SIM card (if applicable, remove the PIN from the SIM card using a cell phone), and install the antenna:

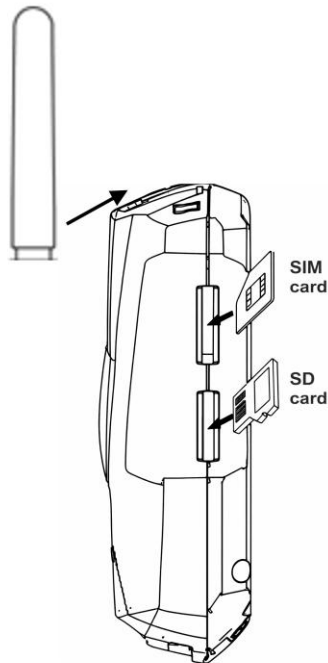

- 2) Power supply: For the initial startup, use the included power supply and follow the instructions in the next image for wiring. If this is the first time you are turning on the device, you will need to plug the power supply into an electrical outlet and then press the "PWR" button:

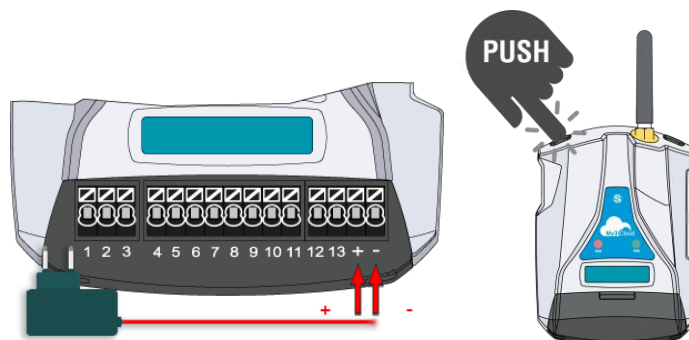

- 3) At this point, the control unit will start up, and the network signal strength will appear on the main display screen:

**3.3. ELECTRICAL CONNECTIONS**

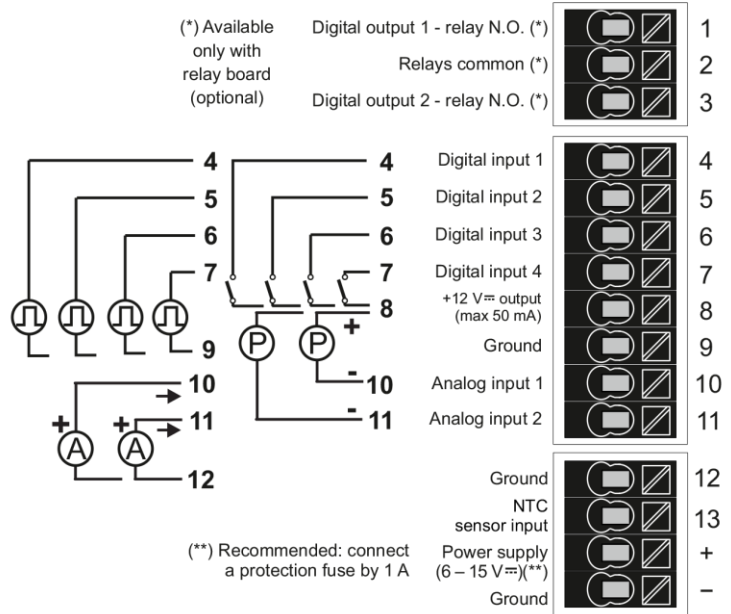
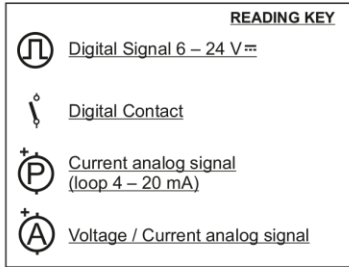

For more information, refer to Installation manual.

## 4. DISPLAY

### 4.1. MAIN MENU

The main menu can be accessed via the main screen:



Press the “PWR” button for a few seconds until the menu appears.

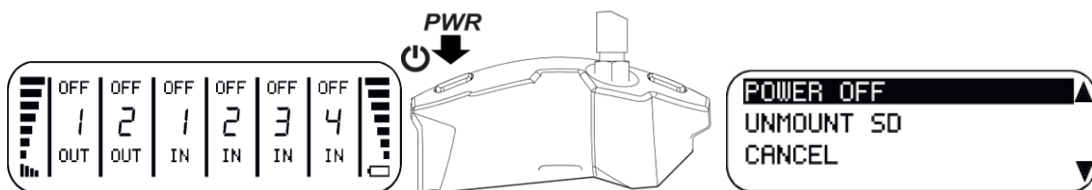

In the main menu it is possible to scroll through the items with the “SCR” key and confirm with the “PWR” key.

#### 4.1.1. MAIN MENU ITEMS

In the main menu, you can choose the following menu items:

##### **POWER OFF**

Confirming with the PWR key, the control unit is switched off

##### **CANCEL**

Confirming with the PWR button exits the main menu

##### **RESTART**

Confirming with the PWR key the device restarts

##### **CONFIG RESET**

Confirming with the PWR button resets the device as at the first start (i.e. the device switches to Access Point mode and loses the previous access point configuration). Re-perform the first start-up procedure.

##### **SESSION RESET**

Confirming with the PWR button closes the connection session in the cloud

##### **SAVE CONFIG**

Confirming with the PWR button forces the saving of the current configuration.

##### **ACCESS POINT MODE / STATION MODE**

Confirming with the PWR button, the control unit restarts in Access Point mode (where the web server is active at the address 192.168.4.1) or in Station mode (where the control unit is connected to the internet via the configured wi-fi router).

##### **SHIPPING MODE**

Confirming with the PWR button, the control unit switches off in "Shipping Mode" in order to preserve the battery in the event of long shutdown times. In this mode, the control unit will switch on only by supplying external power (and in this way it will automatically exit the "Shipping Mode").

##### **WATCHDOG (MY3 CLOUD W-AIR MODEL ONLY)**

This parameter allows you to activate or deactivate the automatic restart of the control unit after every 24 hours of operation.

## 4.1.2. CHANGING ROUTER OR WIFI PARAMETERS (W-AIR MODEL ONLY)

If it is necessary to change the WIFI network (for example, to change the router or because the password or WIFI configuration has been changed), follow the following procedure:

- 1) Access the main menu and scroll through the main menu items with the SCR button until you select the Wi-Fi mode change to “Access Point Mode”

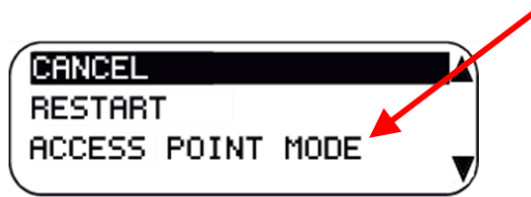

At this point the control unit is in access point mode as at the first start.

- 2) Follow the first start-up procedure in chapter **Errore. L'origine riferimento non è stata trovata.**

## 4.2. SCREEN CHANGE AND CONTEXTUAL MENUS

Starting from the main display it is possible to change the screen by pressing the “SCR” button.

If a small triangle ▲ appears at the top right of the screen, it means that it is possible to access a contextual menu.

To access the contextual menu, press the “SCR” button for a few seconds.

You move through the menu with the “SCR” button and confirm the selection with the “PWR” button.

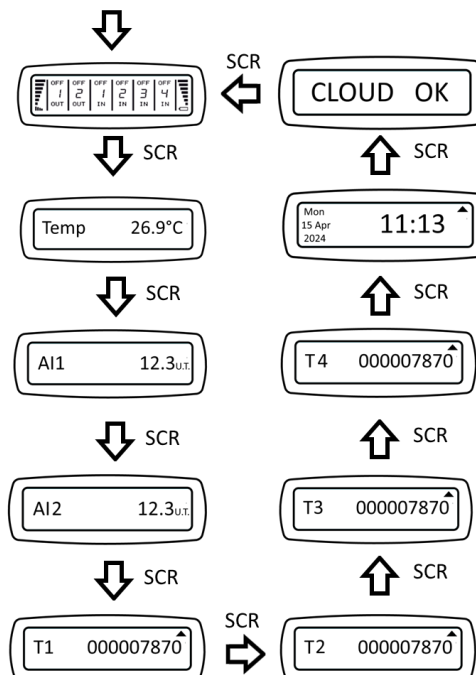

## 4.2.1. MAIN SCREEN

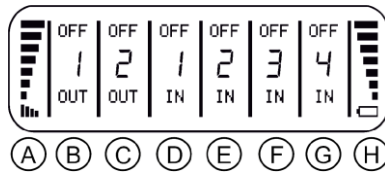

The main screen shows:

- A - WiFi signal level
- B - output relay 1 status
- C - output relay 2 status
- D - digital input 1 status
- E - digital input 2 status
- F - digital input 3 status
- G - digital input 4 status
- H - battery level

## 4.2.2. TEMPERATURE MEASUREMENT SCREEN

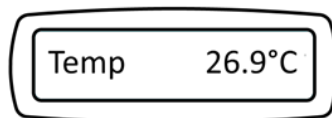

The temperature screen shows the measurement of the temperature sensor (NTC type) expressed in °C.

## 4.2.3. ANALOG INPUT 1 AND 2 SCREENS

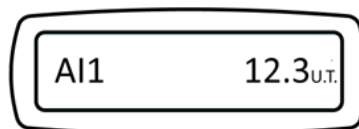

The screens of analog inputs 1 and 2 show the measurements of the two analog inputs in voltage or current expressed in technical units (if the scaling is the default one, the units of measurement are Volts for voltages and mA for currents).

## 4.2.4. TOTALISER SCREENS 1, 2, 3 AND 4

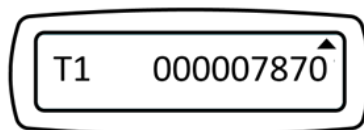

The totalizer screens show the values totalized by the respective digital inputs. If the control unit is turned off, the value of the totalizers is not lost. To reset the totalizers use the context menu.

#### 4.2.5. DATE AND TIME SCREEN

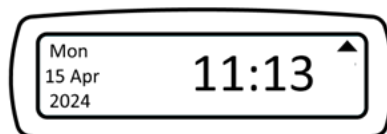

The Date and Time screen shows the current clock value, this information is important when using the sunrise and sunset calculation function.

#### 4.2.6. CONTROL UNIT STATUS SCREEN



This screen shows the status of the control unit, if the connection was successful the text will appear on the display:

**“CLOUD OK”** this means that the control unit is correctly configured and that it has successfully connected to the Seneca cloud.

In case of cloud connection errors, the text will be **“CLOUD ERR”**

Other texts relating to other types of errors are also shown.

## 5. ACTIVATION AND MANAGEMENT OF THE CLOUD SERVICE

To use the MyAlarm3 Cloud monitoring system it is necessary to register a SENECA Cloud account and activate the dedicated service.

**SERVICE:** is the MyAlarm3 Cloud W-AIR device registered to the Seneca Cloud.

**ACCOUNT:** is a natural person registered with the Seneca Cloud and identified by name, surname and email.

- **OWNER ACCOUNT:** is the account that activates and manages the single MyAlarm3 Cloud service of its ownership and responsibility.
- **USER ACCOUNT (GUEST):** this is the account that can use the single MyAlarm3 Cloud service after receiving the invitation from the owner of the service. The owner account can provide the guest user account with three levels of privileges.

### 5.1. USER ACCOUNT (GUEST)

Each activated Service (therefore each MyAlarm3 Cloud W-AIR) is managed solely by the Owner Account, who also has full responsibility for it, while multiple User Accounts (Guest) can use the single service after receiving the invitation from the Owner Account.

Only the Account Owner can invite another account.

The Owner Account can either invite other User Accounts to use his control units as guest users, or be invited by other Owner Accounts.

The User Account is the guest user of MyAlarm3 Cloud W-AIR not owned by it after an invitation to use by the respective Account Owner.

It is not necessary to have a MyAlarm3 Cloud W- AIR to register in the Seneca Cloud and be invited by an Owner Account.

In this way, it is possible to create cross fleets of MyAlarm3 Clouds W- AIR with owners of one or more devices, individual users of a device and system maintainers with access to groups of systems consisting of multiple MyAlarm3 Cloud devices.

The Account Owner can invite a User Account with three levels of privileges:

**GUEST USER ACCOUNT (DEFAULT):** view information, receive notifications.

**GUEST USER ACCOUNT EDITOR:** view information, send commands, receive notifications.

**ADMIN GUEST USER ACCOUNT:** view information, send commands, receive notifications, change settings (can change widgets).

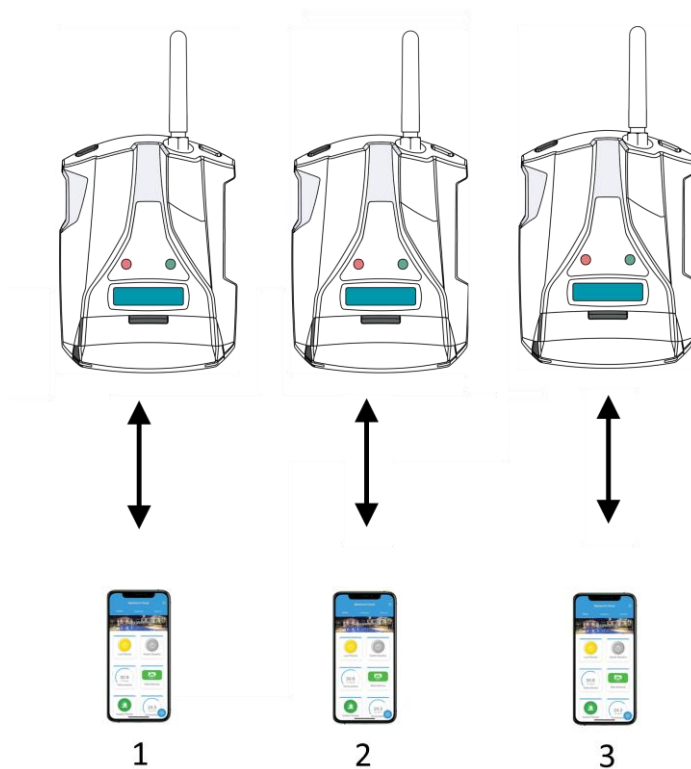
**5.2. EXAMPLES****5.2.1. THREE “OWNER ACCOUNTS” ONLY MANAGE THEIR OWN CONTROL UNIT:**

In this case, control unit 1 will send notifications only to owner account 1, control unit 2 only to owner account 2 etc.

Likewise, only owner account 1 will have access to control unit 1 etc.

**5.2.2. AN “OWNER ACCOUNT” AND TWO “USER ACCOUNTS” MANAGE THE SAME CONTROL UNIT:**

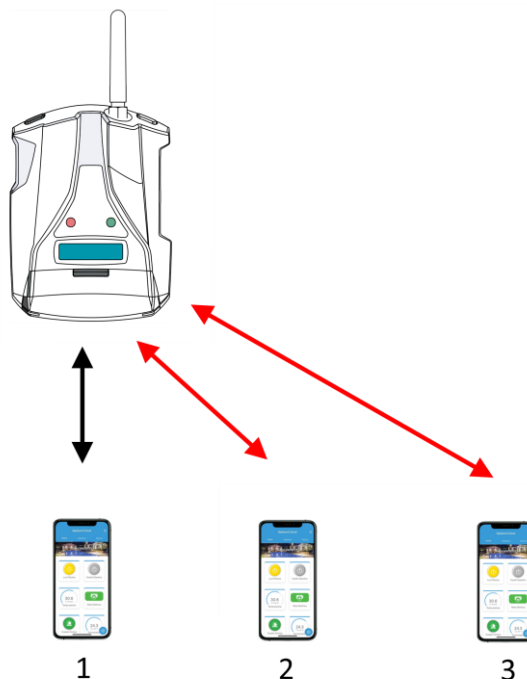

In this example, owner account 1 invited user accounts 2 and 3. The notifications will reach all 3 accounts, accounts 2 and 3 will also be able to access the remote control unit.

### 5.2.3. CROSS INVITATIONS:

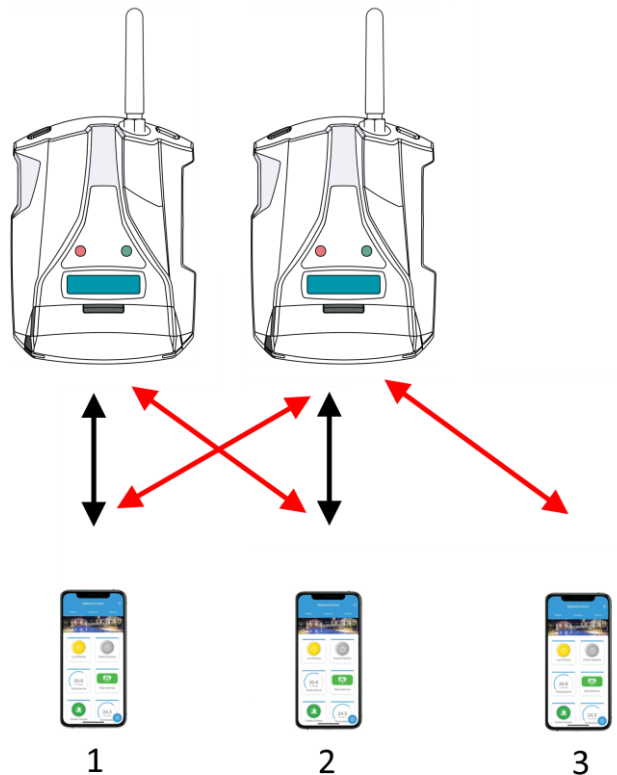

Owner Account 1 manages the first control unit, Owner Account 2 manages the second. However, both can access each other's control unit because they have invited each other. User account 3 only had access to the second control unit. The notifications from the first control unit will arrive at accounts 1 and 2, the notifications from the second control unit will arrive at accounts 1, 2 and 3.

### 5.3. ACCOUNT ACTIVATION

To use MyAlarm3 Cloud it is necessary to register a SENECA Cloud account and activate the dedicated service. The KIT includes a usage fee.

For more information on renewal costs, visit the product page on the Seneca website

The activation procedure is available from both WEB browser and MyAlarm3 Cloud mobile app.

If you have purchased a new MyAlarm3 Cloud and already have a Seneca account, it is not necessary to create a new account but simply add the 5+10 character code on the back of the control unit to your account.

### 5.3.1. ACTIVATING THE ACCOUNT FROM THE MYALARM3 CLOUD APP

- 1) As soon as the APP is launched, create the account and wait for the activation email
- 2) Once you have received the activation email, select the "ACTIVATE ACCOUNT" key;
- 3) After activating the account, connect again to the address <https://cloud.seneca.it> to log in for the first time. Select the "CLOUD SERVICES" key and select "ADD" in the top right hand corner;
- 4) Enter the 5+10 character "Activation Code" on the back of the control unit and select the "ADD" key again;
- 5) From this moment the service is active and the account owner of the control unit can access the MyAlarm3 Cloud system from the APP, as well as invite other users to use its newly activated MyAlarm3 Cloud W-AIR.

### 5.3.2. ACTIVATION OF THE ACCOUNT FROM THE WEB BROWSER

- 1) Connect to <https://cloud.seneca.it> to register your own SENECA Cloud account (if not previously done to activate services related to other MyAlarm3 Cloud W- AIR devices owned or to be able to access as a guest user services related W- AIR to MyAlarm3 Cloud W-AIR belonging to other accounts after their invitation). Wait for the account activation email;
- 2) After receiving the account activation email, select the "ACTIVATE ACCOUNT" key;
- 3) After activating the account, connect again to the address <https://cloud.seneca.it> to log in for the first time. Select the "CLOUD SERVICES" key and select "ADD" in the top right hand corner;
- 4) Enter the 5+10 character "Activation Code" on the back of the control unit and select the "ADD" button again; (\*)
- 5) From this moment the service is active and the account owner of the control unit can access the MyAlarm3 Cloud system from the APP, as well as invite other users to use its newly activated MyAlarm3 Cloud W-AIR.

(\*) The operation requires less than 1 minute during which the device is synchronized with the Seneca Cloud platform.

#### 5.4. INVITE OTHER ACCOUNTS TO CONTROL YOUR CONTROL UNIT

It is possible to invite other accounts to control your control unit from the APP in this way:

- 1) Open the app, select the control unit you want to share, in the options menu select "INVITATIONS" (Available only for the user who owns the Myalarm3 Cloud)
- 2) Enter the email address of the user to invite and the role (GUEST ADMIN, GUEST EDITOR, GUEST USER) to assign, then select the "INVITE" button.
- 3) From this moment on, follow the instructions in the emails that the Seneca Cloud will send to the guest user.

#### 5.5. CANCELLATION OF THE OWNER ACCOUNT

To irreversibly delete the owner account, follow the instructions below:

- 1) Access your Cloud account via the WEB browser:  
<https://cloud.seneca.it>  
or via APP select: "options" → "Account" and selecting the "Manage Cloud Service" button
- 2) Select "Cloud Services"
- 3) Select the "MANAGEMENT" key for the Service you want to reset
- 4) Select the "Remove service" name from the "ADVANCED" menu  
(e.g. Remove MyAlarm3 Cloud Service xxxxx)
- 5) Proceeding with the removal of the service, all the settings and information related to it will be irreversibly reset. The Service will no longer be associated with the owner account and the activation code can be used again by another account (which will become the new owner account of this service)
- 6) The MyAlarm3 Cloud service is reset to factory data.

N.B.: The Owner Account is responsible for Seneca's Cloud service and its renewal, and it is also responsible for the use and maintenance of the control unit. Seneca S.R.L. is not responsible for any inappropriate use and for functions and installations not indicated in this manual.

## **5.6. CHANGE OF OWNERSHIP OF THE CONTROL UNIT FROM ONE OWNER ACCOUNT TO ANOTHER (MOVING FROM INSTALLER TO CUSTOMER)**

To transfer ownership of the MyAlarm3 Cloud control unit to another administrator account

(\*) follow the instructions below:

- 1) Log in to the administrator Cloud account where the service to be transferred is by connecting to the address <https://cloud.seneca.it>
- 2) Select "CLOUD SERVICES"
- 3) Select the "MANAGEMENT" key for the Service you want to transfer
- 4) Select the "Change of ownership" item from the "ADVANCED" menu and enter the email address of the new administrator (\*)
- 5) The new administrator will receive an email summarizing the operation.
- 6) To complete the procedure, the new administrator will have to reactivate the service using the activation code on the back of the product.

(\*) before proceeding with the migration the new owner must have/create its own administrator account.

## 5.7. CLOUD SERVICE RENEWAL

For more information on renewal costs, consult the product page on the [www.seneca.it](http://www.seneca.it) website  
The renewal procedure must be carried out by the owner Account.

Renewal procedure:

- 1) Access the account that owns the service by connecting to the address <https://cloud.seneca.it>
- 2) Select "CLOUD SERVICES"
- 3) Select the "MANAGEMENT" button relating to the Service you intend to renew
- 4) Select the "Renew Service" item from the "ADVANCED" menu (If you need to purchase a renewal code, using the "GO TO CART" button you will be directed to the SENECA portal where you can make the purchase)
- 5) Enter the renewal code in the indicated field and select "APPLY CODE"
- 6) The service expiry date will be extended

## 5.8. REVOKE AN INVITATION TO A GUEST ACCOUNT FROM AN OWNER ACCOUNT

To revoke an invitation to a guest user:

- 1) Log in with the Owner account by connecting to the address: <https://cloud.seneca.it>
- 2) Select "CLOUD SERVICES"
- 3) Select the "MANAGEMENT" button relating to the Service
- 4) In the list of users, select the one you want to delete and press "DELETE"

## 5.9. DELETE THE INVITATION RECEIVED

To remove a guest user via the guest user's account:

- 1) Log in with the Owner account by connecting to the address: <https://cloud.seneca.it>
- 2) Select "CLOUD SERVICES"
- 3) Select the item "Cloud services by invitation"
- 4) Select the "DELETE" button and confirm

## 6. INSTALLATION OF THE EXTERNAL NTC TEMPERATURE PROBE

### **ATTENTION!**

**BEFORE PROCEEDING IT IS NECESSARY TO REMOVE POWER TO THE CONTROL UNIT**

Before proceeding with the installation of the external NTC probe, it is necessary to remove the NTC probe supplied with the control unit. It will be sufficient to cut or remove the probe located on the back of the control unit:

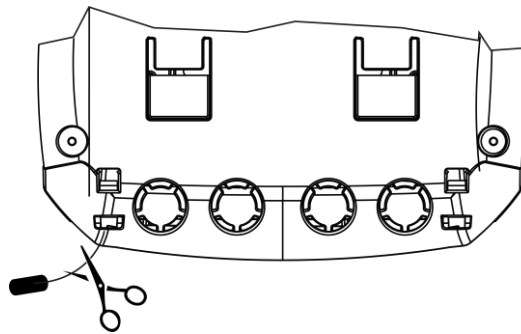

Once the pre-installed probe has been removed, connect the external NTC probe by wiring the cables to terminals 12 and 13 as shown in the figure below:

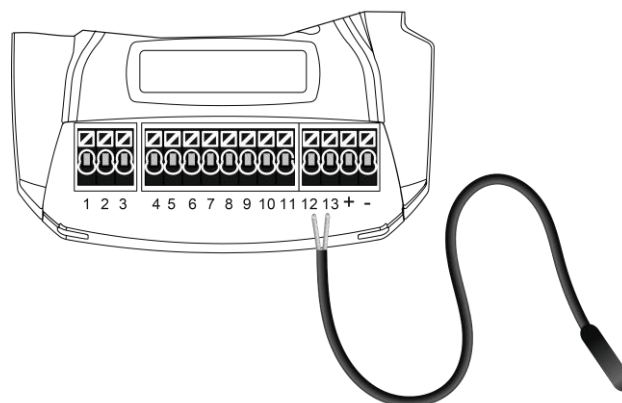

## 7. MANUAL FIRMWARE UPDATE PROCEDURE VIA MICROSD CARD

Normally the firmware is updated via the APP following the procedure indicated in the APP itself.  
If you want to update the firmware manually via micro SD, follow the guide below:

### 7.1. MYALARM 3 CLOUD W-AIR MODEL

- 1) Insert the micro SD into the dedicated reader on the PC;  
Copy the FWOTA2.BIN file downloadable in the download section of the internet page dedicated to the product ([www.seneca.it/prodotti/myalarm3-cloud-w-air](http://www.seneca.it/prodotti/myalarm3-cloud-w-air)) into the main folder of the micro SD;
- 2) Insert the micro SD card into the MyAlarm3 Cloud control unit;
- 3) Switch the control unit on
- 4) Wait for the message confirming the detection of the new firmware;
- 5) Press “OK” and wait for installation to complete with the unit restarting.
- 6) Now the procedure is complete.

### 7.2. MYALARM 3 CLOUD 2G MODEL

- 1) Insert the microSD card into the PC's dedicated card reader;
- 2) Copy the FW2.BIN file which can be downloaded from the download section of the product's website to the root directory of the microSD card;
- 3) Insert the microSD card into the PC's dedicated card reader;
- 4) Powering the control unit
- 5) Wait for the message on the display indicating that the new firmware has been detected;
- 6) Press the “OK” button and wait for the installation process to complete, followed by a reboot of the control unit.
- 7) The process is now complete.

### 7.3. MYALARM 3 CLOUD 4G MODEL

- 1) Insert the microSD card into the PC's dedicated card reader;
- 2) Copy the FW3.BIN file which can be downloaded from the download section of the product's website to the root directory of the microSD card;
- 3) Insert the micro SD card into the MyAlarm3 Cloud control unit;
- 4) Power the control unit
- 5) Wait for the message on the display indicating that the new firmware has been detected;
- 6) Press the “OK” button and wait for the installation process to complete, followed by a reboot of the control unit.
- 7) The process is now complete.

## 8. ENABLING NOTIFICATIONS ON ANDROID 11 OR HIGHER DEVICES

Since revision 11 of Android it is necessary to manually authorize the ability to receive notifications. To do this follow the procedure below:

Locate the MY3 Cloud APP and keep the icon pressed until the menu appears:



Press the “i” icon:



Move the switch to “Allow Notifications” as shown in the figure:

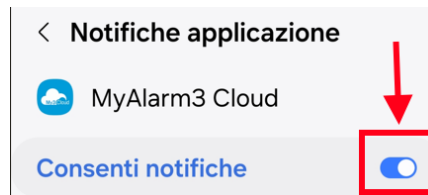

Allow notifications even if the APP is NOT in use as shown in the figure:

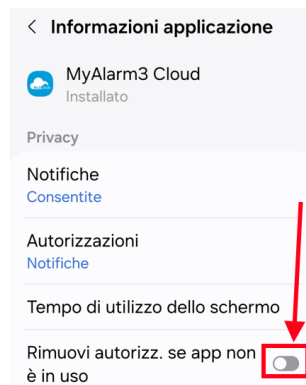

## 9. CUSTOM APN CONFIGURATION (MYALARM 3 CLOUD 2G AND 4G MODELS ONLY)

By default, the device uses a database containing the world’s major APNs; however, you may be using a SIM card whose APN is not included in the database. In this case, you will need to use the SD CARD CONTENT GENERATOR V2 software. This software allows you to create an SD card with a static APN based on your account information.

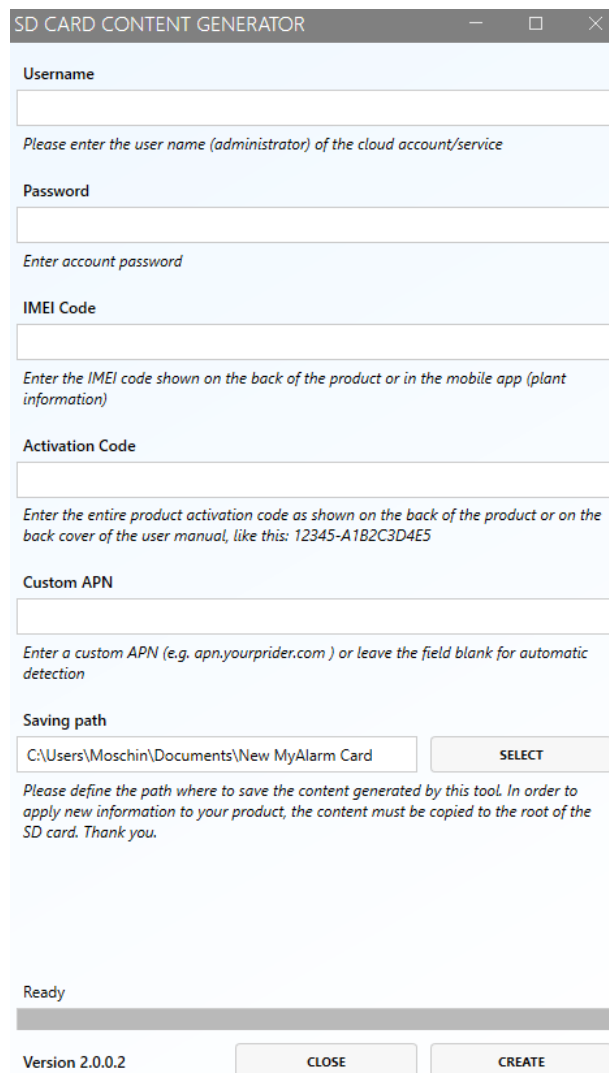

Once you have entered the required information:

- 1) Insert the MyALARM3 Cloud SD card into your PC.
- 2) The SD card must be empty.
- 3) Select the SD card path and press “CREATE”.
- 4) Then insert the SD card into the MyALARM3 Cloud while it is turned off.

- 5) When the SD card is inserted, will the message “LOAD SETUP?” appear on the display, press OK to reload the fwuptd.tag file, which contains the default settings to use when updating or reloading the firmware.
- 6) After rebooting, go back to the device's main menu and run RELOAD CONFIG to ensure that the (encrypted) def.tag file is reloaded.

**ATTENTION!**

**IF THE “RELOAD CONF” COMMAND IS NOT EXECUTED, THE DEVICE WILL IGNORE THE NEW APN CONFIGURATION**

## **10. ENABLING THE DEBUG LOG ON THE SD CARD (MYALARM3 CLOUD 2G AND 4G MODELS ONLY)**

At the request of Seneca Technical Support, you may need to enable the debug log on the SD card. To enable or disable the log on the SD card, follow these steps.

### ENABLING LOGGING TO SD CARD

1. Right-click to open the Controller Status menu (where “CLOUD OK” or “CLOUD ERR” appears)
2. Hold down the right button until the menu appears,
3. Use the right arrow key to scroll, then press the left arrow key to select “**TURN ON LOG ON SD**”.

### DISABLING LOGGING TO THE SD CARD

1. Right-click to open the Controller Status menu (where “CLOUD OK” or “CLOUD ERR” appears)
2. Hold down the right button until the menu appears,
3. Use the right arrow key to scroll, then press the left arrow key to select “**TURN OFF LOG ON SD**”

**ATTENTION!**

***Only remove the SD card when the device is turned off!***

**11. TROUBLESHOOTING**

<b>NOTIFICATIONS</b>	<b>MEANING</b>	<b>SOLUTION</b>
The yellow NET LED flashes quickly and continuously. Signal level at zero	<p>WIFI router connection error.</p> <p>Possible causes:</p> <ol style="list-style-type: none"> <li>1) Incorrect SSID</li> <li>2) Incorrect password</li> <li>3) Control unit too far from the WIFI router</li> <li>4) Antenna wiring error</li> </ol>	<p>Return the control unit to Access Point mode via the main display menu and check the connection data to the WIFI network.</p> <p>Move the MY3 Cloud closer to the WIFI Router or use an external antenna to improve signal reception</p>
The writing "CLOUD ERR" appears on the status screen of the control unit display and the device appears as "OFFLINE" in the APP	The control unit cannot connect to the cloud, possible lack of internet connection	Check that there is an internet connection
The writing "CLOUD OK" appears on the status screen of the control unit display, but the device appears as "OFFLINE" in the APP	The first 24 months of use of the KIT have expired and the Seneca cloud service has not been renewed	Renew your account
-	The temperature measured by the control unit is not precise enough	Use the external NTC probe (see available accessories)