

USER MANUAL

R203 and R204 series with Modbus protocol,
Profinet IO, Ethernet/IP and OPC-UA



SENECA S.r.l.

Via Austria 26 – 35127 – Z.I. - PADOVA (PD) - ITALY
Tel. +39.049.8705355 – 8705355 Fax +39 049.8706287

www.seneca.it



ORIGINAL INSTRUCTIONS

CAUTION

SENECA does not guarantee that all specifications and/or aspects of the product and firmware, included in them, will meet the requirements of the actual final application even if the product referred to in this documentation is in compliance with the technological state of the art.

The user assumes full responsibility and/or risk with regard to the configuration of the product to achieve the intended results in relation to the specific installation and/or end application.

SENECA may, with prior agreement, provide consultancy services for the successful completion of the final application, but under no circumstances can it be held responsible for its proper functioning.

The SENECA product is an advanced product, the operation of which is specified in the technical documentation supplied with the product itself and/or can be downloaded, if desired prior to purchase, from the www.seneca.it website.

SENECA has a policy of continuous development and accordingly reserves the right to make and/or introduce - without prior notice - changes and/or improvements to any product described in this documentation.

The product described in this documentation may solely and exclusively be used by personnel qualified for the specific activity and in accordance with the relevant technical documentation, with particular attention being paid to the safety instructions.

Qualified personnel means personnel who, on the basis of their training, competence and experience, are able to identify risks and avoid potential hazards that could occur during the use of this product.

SENECA products may only be used for the applications and in the manner described in the technical documentation relating to the products themselves.

To ensure proper operation and prevent the occurrence of malfunctions, the transport, storage, installation, assembly, maintenance of SENECA products must comply with the safety instructions and environmental conditions specified in this documentation.

SENECA's liability in relation to its products is governed by the general conditions of sale, which can be downloaded from www.seneca.it.

Neither SENECA nor its employees, within the limits of applicable law, will in any case be liable for any lost profits and/or sales, loss of data and/or information, higher costs incurred for goods and/or replacement services, damage to property and/or persons, interruption of activities and/or provision of services, any direct, indirect, incidental, pecuniary and non-pecuniary, consequential damages in any way caused and/or caused, due to negligence, carelessness, incompetence and/or other liabilities arising from the installation, use and/or inability to use the product.

CONTACT US

Technical support	supporto@seneca.it
Product information	commerciale@seneca.it

This document is the property of SENECA srl.
Copies and reproduction are prohibited unless authorised

Document revisions

DATE	REVISION	NOTES	AUTHOR
23/06/2023	0	First revision	MM
26/06/2023	1	Changed power supply value for R203-L version	AZ
02/10/2023	2	Added table of Rogowski sensor input full scale	AZ
03/11/2023	3	Added -P model Deleted models -1	MM
21/11/2023	4	Supported new firmwares: R203 rev 1030 R203-P rev 1024 For Aron insertion support	MM
01/12/2023	5	Added Dip Switch chapter	MM
05/12/2023	6	Fix Dip Switch name	AZ
07/12/2023	7	Added info on Datalogger and Smart Functions	MM
09/01/2023	8	Added new placeholders for Smart Functions from firmware 1035 %tms and %i	MM
19/02/2024	9	Fix Dip switch table in "Dip Switch" chapter	MM
22/03/2024	10	Added Modbus registers refresh time (Chapter 6.5)	MM
04/04/2024	11	Added new R203-E product	MM
15/05/2024	12	Added new R203-U product	MM
25/07/2024	13	-Fix Counter Frequency -Added Commands for Energy/Counters management -Added Counters for R203-P/-E	MM
04/06/2025	14	Fix Event Datalogger Nr Fix Sample Datalogger Nr Change Sample speed for FW revision 2004 (Modbus) Added new features from firmware rev 2004 (Modbus)	MM
20/06/2025	15	Added new R204 family	MM
09/10/2025	16	Added info MQTT - JSON	AC
04/11/2025	17	added explanations for the abbreviated variables names	MM
05/11/2025	18	Added OPC-UA command and new variables	MM
04/02/2026	19	Added https / tls mode for web server access.	MM
23/02/2026	20	Replacement of "RMS" with "TRUE RMS".	AC
30/03/2026	21	The "Digital Output Function" entry has been updated in the Analog and Digital Output Setup section.	AC

TABLE OF CONTENTS

1. WARNINGS	9
2. INTRODUCTION	10
3. R203 AND R204 SERIES MODELS	10
4. FLEX TECHNOLOGY FOR PROTOCOL CHANGE	11
4.1. CHANGING PROTOCOL WITH SENECA DISCOVERY DEVICE SOFTWARE	13
5. DIP SWITCH	14
6. MEASUREMENTS AVAILABLE FROM ETHERNET/SERIAL	15
6.1. CONVENTIONS	15
6.2. INSTANTANEOUS VALUES	16
6.3. MEDIUM VALUES (IN THE CONFIGURED DEMAND TIME)	17
6.4. ABSOLUTE MAXIMUM / MINIMUM VALUES (SINCE DEVICE POWER UP)	19
6.5. COUNTERS:	21
6.6. HARMONIC ANALYSIS UP TO THE 55TH (MODBUS PROTOCOL MODELS ONLY)	22
7. MEASUREMENT AND CALCULATION TIMES	23
7.1. SAMPLING TIMES	23
7.2. SETTling TIMES FOR TRUE RMS VALUES	23
7.3. ANALOG OUTPUT RESPONSE TIME	23
7.4. UPDATE TIMES OF THE REGISTERS RELATING TO THE HARMONIC ANALYSIS (MODBUS PROTOCOL MODELS ONLY)	23

7.5. UPDATE TIMES OF THE MODBUS REGISTERS (MODBUS PROTOCOL MODELS ONLY)	23
8. MEASUREMENT PRECISION AT 23°C	24
9. ROGOWSKI SENSOR INPUT FULL SCALE	24
10. DATALOGGER (MODBUS PROTOCOL MODELS ONLY)	25
10.1. TIME DATA LOGGER	25
10.2. EVENT DATA LOGGER	25
11. SMART FUNCTIONS FOR SENDING DATA AND EVENTS TO THE CLOUDS (MODBUS PROTOCOL MODELS ONLY)	26
11.1. MQTT(S) CLIENT PROTOCOL	27
11.2. HTTP(S) POST PROTOCOL	27
11.3. FTP CLIENT PROTOCOL	27
11.4. SENDING DATA AND EVENTS WITH OR WITHOUT RECOVERY.....	27
11.5. SENDING COMMANDS TO THE DEVICE VIA MQTT(S) PROTOCOL.....	28
12. CONNECTION OF THE DEVICES TO A NETWORK.....	32
12.1. MODBUS, ETHERNET/IP AND OPC-UA PROTOCOLS MODELS.....	32
12.2. PROFINET IO PROTOCOL MODELS	33
13. I/O COPY USING THE PEER TO PEER FUNCTION WITHOUT WIRING (MODBUS PROTOCOL MODELS ONLY)	34
14. WEB SERVER.....	35
14.1. ACCESS TO THE WEB SERVER	35
15. CONNECTION DIAGNOSTICS.....	36

16. DEVICE CONFIGURATION VIA WEBSERVER (MODBUS PROTOCOL MODELS ONLY)	38
16.1. MEASURES SECTION -> MEASURES SETUP	38
16.2. MEASURES SECTION ->ENERGY TOTALIZER SETUP	39
16.3. DATALOGGER SECTION-> SETUP DATALOGGER	39
16.4. SYSTEM SETTINGS SECTION -> SYSTEM SETTINGS	39
16.5. SYSTEM SETTINGS SECTION -> SYSTEM ETHERNET	40
16.6. SYSTEM SETTINGS SECTION -> SYSTEM TIME	40
16.7. SYSTEM CONNECTION SECTION -> MODBUS	41
16.8. SYSTEM CONNECTION SECTION -> FTP	42
16.9. SYSTEM CONNECTION SECTION -> MQTT	42
16.9.1. Examples	61
16.9.2. DIREL ADM4.0	61
16.9.3. SENECA CLOUDBOX 2	61
16.10. SYSTEM CONNECTION SECTION -> HTTP	62
16.11. SYSTEM CONNECTION SECTION -> P2P	77
16.12. ANALOG AND DIGITAL OUTPUT SETUP SECTION	77
16.13. INPUT DIGITAL SETUP SECTION	78
17. DEVICE CONFIGURATION VIA WEBSERVER (ETHERNET/IP, PROFINET IO, OPC-UA PROTOCOL MODELS ONLY)	84
17.1. COMMUNICATION SETUP SECTION	84
17.2. MEASURES SETUP SECTION	85
17.3. CONNECTION DIAGNOSTIC SECTION	86
17.4. OPC-UA CONFIGURATION SECTION (OPC-UA PROTOCOL MODELS ONLY)	86

18. DOWNLOADING THE DATALOGGER FILES (MODBUS PROTOCOL MODELS ONLY).	100
19. MODBUS PASSTHROUGH (MODBUS PROTOCOL MODELS ONLY).....	101
20. FIRMWARE UPDATE	102
21. RESETTING THE DEVICE TO ITS FACTORY CONFIGURATION	102
22. MODBUS COMMUNICATION PROTOCOL (MODBUS PROTOCOL MODELS ONLY)	103
22.1. SUPPORTED MODBUS FUNCTION CODES	103
22.2. MODBUS REGISTER TABLE	104
22.3. NUMBERING OF "0-BASED" OR "1-BASED" MODBUS ADDRESSES	104
22.4. NUMBERING OF MODBUS ADDRESSES WITH "0-BASED" CONVENTION.....	105
22.5. NUMBERING OF MODBUS ADDRESSES WITH "1 BASED" CONVENTION (STANDARD)	105
22.6. BIT CONVENTION WITHIN A MODBUS HOLDING REGISTER.....	106
22.7. MSB AND LSB BYTE CONVENTION WITHIN A MODBUS HOLDING REGISTER....	106
22.8. REPRESENTATION OF A 32-BIT VALUE IN TWO CONSECUTIVE MODBUS HOLDING REGISTERS.....	107
22.9. TYPE OF 32-BIT FLOATING POINT DATA (IEEE 754)	107
22.10. MODBUS 4X HOLDING REGISTERS TABLE (FUNCTION CODE 3).....	109
23. PROFINET IO COMMUNICATION PROTOCOL (MODBUS PROTOCOL MODELS ONLY)	217
23.1. CREATING A PROJECT WITH SIEMENS PLC (TIA PORTAL 16) (PROFINET IO PROTOCOL MODELS ONLY).....	217
23.1.1. INSTALLING THE GSDML FILE	218
23.1.2. INSERTION OF THE SIEMENS PLC IN THE PROJECT	219

23.1.3.	INSERTION OF THE PROFINET SENECA IO	222
23.1.4.	CONFIGURATION OF THE PARAMETERS OF THE SENECA DEVICE	225
23.1.5.	CONFIGURATION PARAMETERS OF THE GSDML FILE.....	226
23.1.6.	I/O DATA	227
24.	ETHERNET/IP COMMUNICATION PROTOCOL (ETHERNET/IP PROTOCOL MODELS ONLY).....	240
24.1.	CREATING A PROJECT WITH PLC ALLEN BRADLEY/ROCKWELL (RS-LOGIX5000 / STUDIO 5000 LOGIX DESIGNER 35.00.00)	240
25.	OPC-UA COMMUNICATION PROTOCOL (OPC-UA PROTOCOL MODELS ONLY).....	249
25.1.	OPC VARIABLE NAMES	249
25.2.	UAEXPERT™ CLIENT CONFIGURATION	256

1. WARNINGS

 **ATTENTION!**

This user manual extends the information from the installation manual to the configuration of the device. Use the installation manual for more information.

 **ATTENTION!**

In any case, SENECA s.r.l. or its suppliers will not be responsible for the loss of data/revenue or consequential or incidental damages due to negligence or bad/improper management of the device, even if SENECA is well aware of these possible damages.

SENECA, its subsidiaries, affiliates, group companies, suppliers and distributors do not guarantee that the functions fully meet the customer's expectations or that the device, firmware and software should have no errors or operate continuously.

2. INTRODUCTION

The three-phase smart energy meters of the R203 and R204 series allow the measurement and calculation of electrical quantities such as voltage, current, power, energy, harmonics, etc.

The devices are equipped with a universal current input (TA with current output, TA with voltage output, Rogowski sensors) and support single-phase and three-phase 3- or 4-wire insertion types.

Measurements and calculations are made available via communication protocols depending on the model.

In some models It is also possible to activate the data logger and send the data to the clouds via the MQTT(s), HTTP(s) or FTP protocols.

3. R203 AND R204 SERIES MODELS

The R203 and R204 series models are shown in the table:

MODEL	NUMBER OF ETHERNET PORTS	POWER SUPPLY	COMMUNICATION PROTOCOLS	I/O	DATALOGGER	SENDING DATA TO CLOUD(SMART FUNCTIONS)
R203-2-L	2	10 ÷ 30Vdc	MODBUS TCP-IP SERVER MODBUS RTU MQTT(s) HTTP(s) FTP	2 Digital Input 2 Digital Output 2 Digital Counter @ 32 bit in Not volatile memory 1 Analog Output	YES	YES
R203-2-H	2	90 ÷ 264Vac	MODBUS TCP-IP SERVER MODBUS RTU SLAVE MQTT(s) CLIENT HTTP(s) CLIENT FTP CLIENT	2 Digital Input 2 Digital Output 2 Digital Counter @ 32 bit in Not volatile memory 1 Analog Output	YES	YES
R203-2-L-P	2	10 ÷ 30Vdc	PROFINET IO DEVICE	2 Digital Input 2 Digital Output 2 Digital Counter @ 32 bit in Not volatile memory 1 Analog Output	NO	NO
R203-2-H-P	2	90 ÷ 264Vac	PROFINET IO DEVICE	2 Digital Input 2 Digital Output 2 Digital Counter @ 32 bit in Not volatile memory 1 Analog Output	NO	NO

R203-2-L-E	2	10 ÷ 30Vdc	ETHERNET/IP ADAPTER	2 Digital Input 2 Digital Output 2 Digital Counter @ 32 bit in Not volatile memory 1 Analog Output	NO	NO
R203-2-H-E	2	90 ÷ 264Vac	ETHERNET/IP ADAPTER	2 Digital Input 2 Digital Output 2 Digital Counter @ 32 bit in Not volatile memory 1 Analog Output	NO	NO
R203-2-L-U	2	10 ÷ 30Vdc	OPC-UA SERVER	2 Digital Input 2 Digital Output 2 Digital Counter @ 32 bit in Not volatile memory 1 Analog Output	NO	NO
R203-2-H-U	2	90 ÷ 264Vac	OPC-UA SERVER	2 Digital Input 2 Digital Output 2 Digital Counter @ 32 bit in Not volatile memory 1 Analog Output	NO	NO
R204-2-L	2	10 ÷ 30Vdc	MODBUS TCP-IP SERVER MODBUS RTU MQTT(s) HTTP(s) FTP	2 Digital Input 2 Digital Output 2 Digital Counter @ 32 bit in Not volatile memory	YES	YES
R204-2-L-P	2	10 ÷ 30Vdc	PROFINET IO DEVICE	2 Digital Input 2 Digital Output 2 Digital Counter @ 32 bit in Not volatile memory	NO	NO
R204-2-L-E	2	10 ÷ 30Vdc	ETHERNET/IP ADAPTER	2 Digital Input 2 Digital Output 2 Digital Counter @ 32 bit in Not volatile memory	NO	NO
R204-2-L-U	2	10 ÷ 30Vdc	OPC-UA SERVER	2 Digital Input 2 Digital Output 2 Digital Counter @ 32 bit in Not volatile memory	NO	NO

4. FLEX TECHNOLOGY FOR PROTOCOL CHANGE



The R203 and R204 series devices include Flex technology.

Flex allows you to change the combination of industrial communication protocols supported at will from a list of available ones, the development is continuously updated, for a complete list refer to the page:

<https://www.seneca.it/flex/>

Some examples of supported protocols are:



The power meter then becomes “universal” and compatible with Siemens or Rockwell or Schneider systems etc... without the need to purchase different hardware.

4.1. CHANGING PROTOCOL WITH SENECA DISCOVERY DEVICE SOFTWARE

From revision 2.8 the Seneca Discovery Device software identifies the devices that support the “Flex” technology:

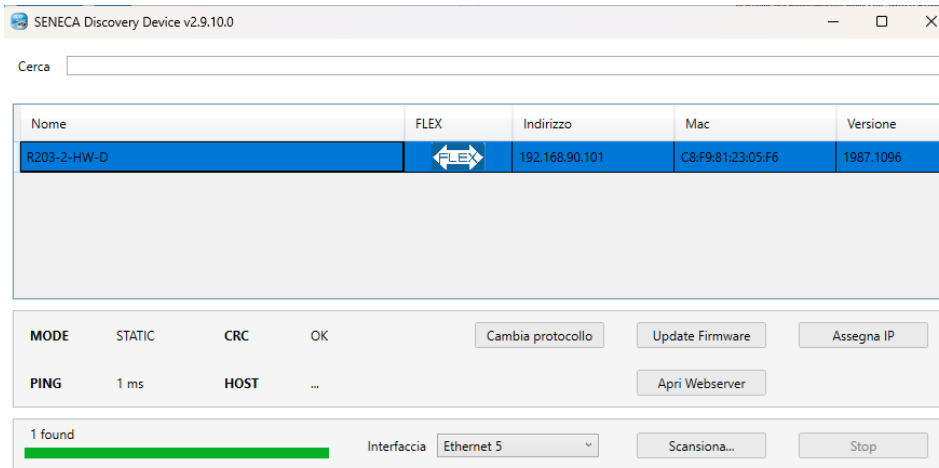

It is possible to press the “Change Protocol” button and select the destination protocol from those in the list:

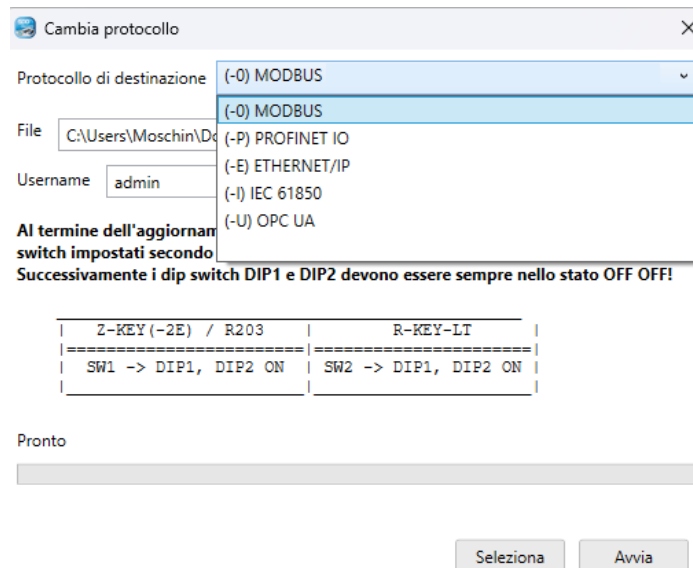

At the end of the operation, bring (only at the first power-on) the dip switches 1 and 2 to “ON” to force the device to default (see also the chapter “RESETTING THE DEVICE TO ITS FACTORY CONFIGURATION”).

5. DIP SWITCH

The devices are fitted with 2 dip switches.
The position of the dip switches is shown in the figure.



Below is the meaning of the SW1 dip switches:

<i>DIP1</i>	<i>DIP2</i>	<i>MEANING</i>
OFF	OFF	Normal operation: The device loads the configuration from the flash.
ON	ON	Resets the device to its factory configuration
OFF	ON	Disables access to the Web server
ON	OFF	Forces the device IP address to 192.168.90.101

6. MEASUREMENTS AVAILABLE FROM ETHERNET/SERIAL

6.1. CONVENTIONS

The device provides the measurement values on all 4 quadrants, the conventions for the signs of the measurements used in the product are summarized in the following image:

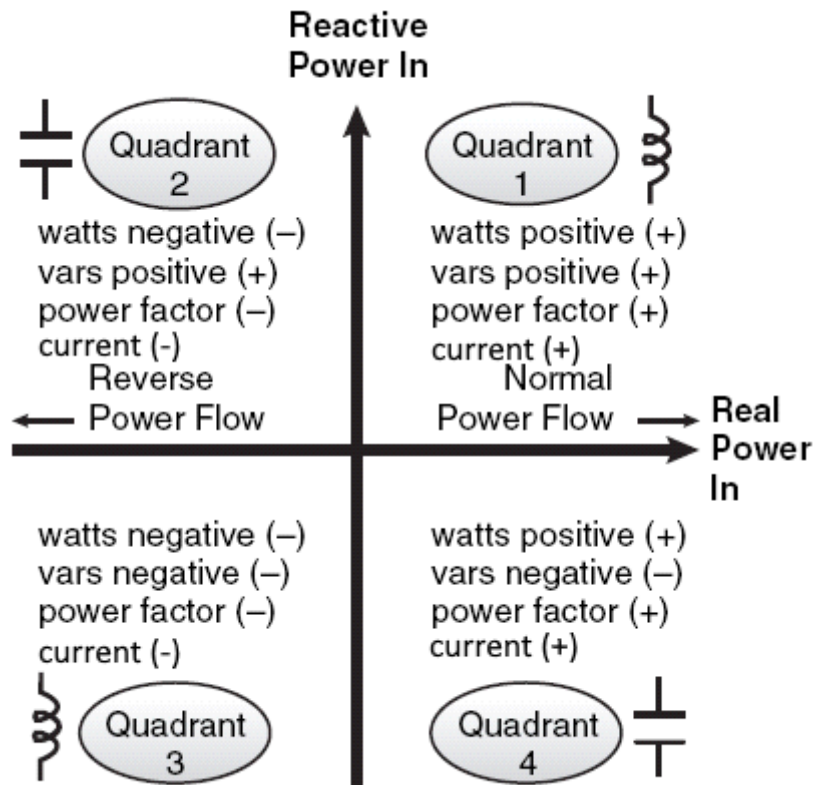

Where:

quadrant Q1 relates to an inductive load with imported (absorbed) active energy, classic use case.

quadrant Q2 relates to a capacitive load with exported (generated) active energy.

quadrant Q3 relates to an inductive load with exported (generated) active energy.

quadrant Q4 relates to a capacitive load with imported (absorbed) active energy.

6.2. INSTANTANEOUS VALUES

VARIABLE	DESCRIPTION
V1N	Voltage between Phase 1 and neutral
V2N	Voltage between Phase 2 and neutral
V3N	Voltage between Phase 3 and neutral
AN	Neutral Current
V12	Phase-to-phase voltage between Phase 1 and 2
V23	Phase-to-phase voltage between Phase 2 and 3
V31	Phase-to-phase voltage between Phase 3 and 1
Vsys	System voltage:
A1	Phase 1 current
A2	Phase 2 current
A3	Phase 3 current
Asys	System current
P1	Phase 1 Active power
P2	Phase 2 Active power
P3	Phase 3 Active power
Psys	System Active power
S1	Phase 1 apparent power
S2	Phase 2 apparent power
S3	Phase 3 apparent power
Ssys	System apparent power
Q1	Phase 1 Reactive power
Q2	Phase 2 Reactive power
Q3	Phase 3 Reactive power
Qsys	System Reactive power
TPF1	Phase 1 Power factor
TPF2	Phase 2 Power factor
TPF3	Phase 3 Power factor
TPFsys	System Power factor
THD-V1N	Voltage THD (Total Harmonic Distortion) between Phase 1 and neutral
THD-V2N	Voltage THD between Phase 2 and neutral
THD-V3N	Voltage THD between Phase 3 and neutral
f	Phase frequency (read from Phase 1)
THD-A1N	Phase 1 current THD
THD-A2N	Phase 2 current THD
THD-A3N	Phase 3 current THD
DIGITAL_IN_1	Digital Input 1
DIGITAL_IN_2	Digital Input 2
DIGITAL_OUT_1	Digital output 1
DIGITAL_OUT_2	Digital output 2

6.3. MEDIUM VALUES (IN THE CONFIGURED DEMAND TIME)

VARIABLE	DESCRIPTION
V1N_AVG	Phase 1 to Neutral Voltage (in demand time)
V1N_AVG_MIN	Phase 1 to minimum neutral voltage (in demand time)
V1N_AVG_MAX	Phase 1 to maximum neutral voltage (in demand time)
V2N_AVG	Phase 2 to Neutral Voltage (in demand time)
V2N_AVG_MIN	Phase 2 to minimum neutral voltage (in demand time)
V2N_AVG_MAX	Phase 2 to maximum neutral voltage (in demand time)
V3N_AVG	Phase 3 to Neutral Voltage (in demand time)
V3N_AVG_MIN	Phase 3 to minimum neutral voltage (in demand time)
V3N_AVG_MAX	Phase 3 to maximum neutral voltage (in demand time)
AN_AVG	Neutral Current (on demand time)
AN_AVG_MIN	Minimum neutral current (in demand time)
AN_AVG_MAX	Maximum neutral current (in demand time)
V12_AVG	Phase-to-phase voltage between Phase 1 and 2 (in demand time)
V12_AVG_MIN	Phase-to-phase voltage between minimum Phase 1 and 2 (in demand time)
V12_AVG_MAX	Phase-to-phase voltage between maximum Phase 1 and 2 (in demand time)
V23_AVG	Phase-to-phase voltage between Phase 2 and 3 (in demand time)
V23_AVG_MIN	Phase-to-phase voltage between minimum Phase 2 and 3 (in demand time)
V23_AVG_MAX	Phase-to-phase voltage between maximum Phase 2 and 3 (in demand time)
V31_AVG	Phase-to-phase voltage between Phase 3 and 1 (in demand time)
V31_AVG_MIN	Phase-to-phase voltage between minimum Phase 3 and 1 (in demand time)
V31_AVG_MAX	Phase-to-phase voltage between maximum Phase 3 and 1 (in demand time)
Vsys_AVG	System voltage (in demand time)
Vsys_AVG_MIN	Minimum system voltage (in demand time)
Vsys_AVG_MAX	Maximum system voltage (in demand time)
A1_AVG	Phase 1 current (in demand time)
A1_AVG_MIN	Minimum Phase 1 current (in demand time)
A1_AVG_MAX	Maximum Phase 1 current (in demand time)

A2_AVG	Phase 2 current (in demand time)
A2_AVG_MIN	Minimum Phase 2 current (in demand time)
A2_AVG_MAX	Maximum Phase 2 current (in demand time)
A3_AVG	Phase 3 current (in demand time)
A3_AVG_MIN	Minimum Phase 3 current (in demand time)
A3_AVG_MAX	Maximum Phase 3 current (in demand time)
Asys_AVG	System current (in demand time)
Asys_AVG_MIN	Minimum system current (in demand time)
Asys_AVG_MAX	Maximum system current (in demand time)
P1_AVG	Phase 1 active power (in demand time)
P1_AVG_MIN	Minimum Phase 1 active power (in demand time)
P1_AVG_MAX	Maximum Phase 1 active power (in demand time)
P2_AVG	Phase 2 active power (in demand time)
P2_AVG_MIN	Minimum Phase 2 active power (in demand time)
P2_AVG_MAX	Maximum Phase 2 active power (in demand time)
P3_AVG	Phase 3 active power (in demand time)
P3_AVG_MIN	Minimum Phase 3 active power (in demand time)
P3_AVG_MAX	Maximum Phase 3 active power (in demand time)
Psys_AVG	System active power (in demand time)
Psys_AVG_MIN	Minimum system active power (in demand time)
Psys_AVG_MAX	Maximum system active power (in demand time)
S1_AVG	Phase 1 apparent power (in demand time)
S1_AVG_MIN	Minimum Phase 1 apparent power (in demand time)
S1_AVG_MAX	Maximum Phase 1 apparent power (in demand time)
S2_AVG	Phase 2 apparent power (in demand time)
S2_AVG_MIN	Minimum Phase 2 apparent power (in demand time)
S2_AVG_MAX	Maximum Phase 2 apparent power (in demand time)
S3_AVG	Phase 3 apparent power (in demand time)
S3_AVG_MIN	Minimum Phase 3 apparent power (in demand time)
S3_AVG_MAX	Maximum Phase 3 apparent power (in demand time)
Ssys_AVG	System apparent power (in demand time)
Ssys_AVG_MIN	Minimum system apparent power (in demand time)
Ssys_AVG_MAX	Maximum system apparent power (in demand time)
Q1_AVG	Phase 1 reactive power (in demand time)
Q1_AVG_MIN	Minimum Phase 1 reactive power (in demand time)
Q1_AVG_MAX	Maximum Phase 1 reactive power (in demand time)
Q2_AVG	Phase 2 reactive power (in demand time)
Q2_AVG_MIN	Minimum Phase 2 reactive power (in demand time)
Q2_AVG_MAX	Maximum Phase 2 reactive power (in demand time)
Q3_AVG	Phase 3 reactive power (in demand time)
Q3_AVG_MIN	Minimum Phase 3 reactive power (in demand time)
Q3_AVG_MAX	Maximum Phase 3 reactive power (in demand time)
Qsys_AVG	System reactive power (in demand time)

Qsys_AVG_MIN	Minimum system reactive power (in demand time)
Qsys_AVG_MAX	Maximum system reactive power (in demand time)
TPF1_AVG	Phase 1 power factor (in demand time)
TPF1_AVG_MIN	Minimum Phase 1 power factor (in demand time)
TPF1_AVG_MAX	Maximum Phase 1 power factor (in demand time)
TPF2_AVG	Phase 2 power factor (in demand time)
TPF2_AVG_MIN	Minimum Phase 2 power factor (in demand time)
TPF2_AVG_MAX	Maximum Phase 2 power factor (in demand time)
TPF3_AVG	Phase 3 power factor (in demand time)
TPF3_AVG_MIN	Minimum Phase 3 power factor (in demand time)
TPF3_AVG_MAX	Maximum Phase 3 power factor (in demand time)
TPFsys_AVG	System power factor (in demand time)
TPFsys_AVG_MIN	Minimum system power factor (in demand time)
TPFsys_AVG_MAX	Maximum system power factor (in demand time)
THD-V1N_AVG	Voltage THD between Phase 1 and neutral (in demand time)
THD-V1N_AVG_MIN	Minimum voltage THD between Phase 1 and neutral (in demand time)
THD-V1N_AVG_MAX	Maximum voltage THD between Phase 1 and neutral (in demand time)
THD-V2N_AVG	Voltage THD between Phase 2 and neutral (in demand time)
THD-V2N_AVG_MIN	Minimum voltage THD between Phase 2 and neutral (in demand time)
THD-V2N_AVG_MAX	Maximum voltage THD between Phase 2 and neutral (in demand time)
THD-V3N_AVG	Voltage THD between Phase 3 and neutral (in demand time)
THD-V3N_AVG_MIN	Minimum voltage THD between Phase 3 and neutral (in demand time)
THD-V3N_AVG_MAX	Maximum voltage THD between Phase 3 and neutral (in demand time)
THD-A1N_AVG	Phase 1 current THD (in demand time)
THD-A1N_AVG_MIN	Minimum Phase 1 current THD (in demand time)
THD-A1N_AVG_MAX	Maximum Phase 1 current THD (in demand time)
THD-A2N_AVG	Phase 2 current THD (in demand time)
THD-A2N_AVG_MIN	Minimum Phase 2 current THD (in demand time)
THD-A2N_AVG_MAX	Maximum Phase 2 current THD (in demand time)
THD-A3N_AVG	Phase 3 current THD (in demand time)
THD-A3N_AVG_MIN	Minimum Phase 3 current THD (in demand time)
THD-A3N_AVG_MAX	Maximum Phase 3 current THD (in demand time)

6.4. ABSOLUTE MAXIMUM / MINIMUM VALUES (SINCE DEVICE POWER UP)

VARIABLE	DESCRIPTION
V1N_MIN	Minimum voltage between Phase 1 and neutral (from switch-on)
V1N_MAX	Maximum voltage between Phase 1 and neutral (from switch-on)
V2N_MIN	Minimum voltage between Phase 2 and neutral (from switch-on)

V2N_MAX	Maximum voltage between Phase 2 and neutral (from switch-on)
V3N_MIN	Minimum voltage between Phase 3 and neutral (from switch-on)
V3N_MAX	Maximum voltage between Phase 3 and neutral (from switch-on)
AN_MIN	Minimum neutral current (from switch-on)
AN_MAX	Maximum neutral current (from switch-on)
V12_MIN	Minimum phase-to-phase voltage between Phase 1 and 2 (from switch-on)
V12_MAX	Maximum phase-to-phase voltage between Phase 1 and 2 (from switch-on)
V23_MIN	Minimum phase-to-phase voltage between Phase 2 and 3 (from switch-on)
V23_MAX	Maximum phase-to-phase voltage between Phase 2 and 3 (from switch-on)
V31_MIN	Minimum phase-to-phase voltage between Phase 3 and 1 (from switch-on)
V31_MAX	Maximum phase-to-phase voltage between Phase 3 and 1 (from switch-on)
Vsys_MIN	Minimum system voltage (from switch-on)
Vsys_MAX	Maximum system voltage (from switch-on)
A1_MIN	Minimum Phase 1 current (from switch-on)
A1_MAX	Maximum Phase 1 current (from switch-on)
A2_MIN	Minimum Phase 2 current (from switch-on)
A2_MAX	Maximum Phase 2 current (from switch-on)
A3_MIN	Minimum Phase 3 current (from switch-on)
A3_MAX	Maximum Phase 3 current (from switch-on)
Asys_MIN	Minimum system current (from switch-on)
Asys_MAX	Maximum system current (from switch-on)
P1_MIN	Minimum Phase 1 active power (from switch-on)
P1_MAX	Maximum Phase 1 active power (from switch-on)
P2_MIN	Minimum Phase 2 active power (from switch-on)
P2_MAX	Maximum Phase 2 active power (from switch-on)
P3_MIN	Minimum Phase 3 active power (from switch-on)
P3_MAX	Maximum Phase 3 active power (from switch-on)
Psys_MIN	Minimum system active power (from switch-on)
Psys_MAX	Maximum system active power (from switch-on)
S1_MIN	Minimum Phase 1 apparent power (from switch-on)
S1_MAX	Maximum Phase 1 apparent power (from switch-on)
S2_MIN	Minimum Phase 2 apparent power (from switch-on)
S2_MAX	Maximum Phase 2 apparent power (from switch-on)
S3_MIN	Minimum Phase 3 apparent power (from switch-on)
S3_MAX	Maximum Phase 3 apparent power (from switch-on)
Ssys_MIN	Minimum system apparent power (from switch-on)
Ssys_MAX	Maximum system apparent power (from switch-on)
Q1_MIN	Minimum Phase 1 reactive power (from switch-on)
Q1_MAX	Maximum Phase 1 reactive power (from switch-on)
Q2_MIN	Minimum Phase 2 reactive power (from switch-on)
Q2_MAX	Maximum Phase 2 reactive power (from switch-on)
Q3_MIN	Minimum Phase 3 reactive power (from switch-on)
Q3_MAX	Maximum Phase 3 reactive power (from switch-on)

Qsys_MIN	Minimum system reactive power (from switch-on)
Qsys_MAX	Maximum system reactive power (from switch-on)
TPF1_MIN	Minimum Phase 1 power factor (from switch-on)
TPF1_MAX	Maximum Phase 1 power factor (from switch-on)
TPF2_MIN	Minimum Phase 2 power factor (from switch-on)
TPF2_MAX	Maximum Phase 2 power factor (from switch-on)
TPF3_MIN	Minimum Phase 3 power factor (from switch-on)
TPF3_MAX	Maximum Phase 3 power factor (from switch-on)
TPFsys_MIN	Minimum system power factor (from switch-on)
TPFsys_MAX	Minimum system power factor (from switch-on)
THD-V1N_MIN	Minimum voltage THD between Phase 1 and neutral (from switch-on)
THD-V1N_MAX	Maximum voltage THD between Phase 1 and neutral (from switch-on)
THD-V2N_MIN	Minimum voltage THD between Phase 2 and neutral (from switch-on)
THD-V2N_MAX	Maximum voltage THD between Phase 2 and neutral (from switch-on)
THD-V3N_MIN	Minimum voltage THD between Phase 3 and neutral (from switch-on)
THD-V3N_MAX	Maximum voltage THD between Phase 3 and neutral (from switch-on)
THD-A1N_MIN	Minimum Phase 1 current THD (from switch-on)
THD-A1N_MAX	Maximum Phase 1 current THD (from switch-on)
THD-A2N_MIN	Minimum Phase 2 current THD (from switch-on)
THD-A2N_MAX	Maximum Phase 2 current THD (from switch-on)
THD-A3N_MIN	Minimum Phase 3 current THD (from switch-on)
THD-A3N_MAX	Maximum Phase 3 current THD (from switch-on)

6.5. COUNTERS:

All counters are stored in non-volatile memory.

VARIABLE	DESCRIPTION
+WH1	Phase 1 positive active energy
+WH2	Phase 2 positive active energy
+WH3	Phase 3 positive active energy
+Wh	Total positive active energy
-WH1	Phase 1 negative active energy
-WH2	Phase 2 negative active energy
-WH3	Phase 3 negative active energy
-Wh	Total negative active energy
VAh1	Phase 1 apparent energy
VAh2	Phase 2 apparent energy
VAh3	Phase 3 apparent energy
VAh	Total apparent energy
+VARh1-L[Q1]	Phase 1 positive inductive reactive energy (Q1)
+VARh2-L[Q1]	Phase 2 positive inductive reactive energy (Q1)
+VARh3-L[Q1]	Phase 3 positive inductive reactive energy (Q1)

+VARh-L[Q1]	Total positive inductive reactive energy (Q1)
-VARh1-C[Q4]	Phase 1 negative capacitive reactive energy (Q4)
-VARh2-C[Q4]	Phase 2 negative capacitive reactive energy (Q4)
-VARh3-C[Q4]	Phase 3 negative capacitive reactive energy (Q4)
-VARh-C[Q4]	Total negative capacitive reactive energy (Q4)
-VARh1-L[Q3]	Phase 1 negative inductive reactive energy (Q3)
-VARh2-L[Q3]	Phase 2 negative inductive reactive energy (Q3)
-VARh3-L[Q3]	Phase 3 negative inductive reactive energy (Q3)
-VARh-L[Q3]	Total negative inductive reactive energy (Q3)
+VARh1-C[Q2]	Phase 1 positive capacitive reactive energy (Q2)
+VARh2-C[Q2]	Phase 2 positive capacitive reactive energy (Q2)
+VARh3-C[Q2]	Phase 3 positive capacitive reactive energy (Q2)
+VARh-C[Q2]	Total positive capacitive reactive energy (Q2)
Wh	Total active energy
VARh	Total reactive energy
VARh-L[Q1Q3]	Total inductive reactive energy (Q1+Q3)
VARh-C[Q2Q4]	Total capacitive reactive energy (Q2+Q4)
VAh	Total apparent energy
COUNTER 1	32-bit input pulse counter 1. (MAXIMUM COUNTERS FREQUENCY 50 Hz)
COUNTER 2	32-bit input pulse counter 2. (MAXIMUM COUNTERS FREQUENCY 50 Hz)
TOT KVARh L1	Phase 1 total reactive energy
TOT KVARh L2	Phase 2 total reactive energy
TOT KVARh L3	Phase 3 total reactive energy
Wh1	Phase 1 total active energy
Wh2	Phase 2 total active energy
Wh3	Phase 3 total active energy

6.6. HARMONIC ANALYSIS UP TO THE 55TH (MODBUS PROTOCOL MODELS ONLY)

VOLTAGE HARMONICS FROM THE FUNDAMENTAL TO THE 55 TH [V]	VL1-N, VL2-N, VL3-N
CURRENT HARMONICS FROM THE FUNDAMENTAL TO THE 55 TH [A]	IL1, IL2, IL3
VOLTAGE HARMONICS FROM THE 2 ND TO THE 55 TH [% IN COMPARISON WITH THE FUNDAMENTAL]	VL1-N, VL2-N, VL3-N
CURRENT HARMONICS FROM THE 2 ND TO THE 55 TH [% IN COMPARISON WITH THE FUNDAMENTAL]	IL1, IL2, IL3

7. MEASUREMENT AND CALCULATION TIMES

7.1. SAMPLING TIMES

The sampling time of the current channels is 8000 samples per second.

The sampling time of the voltage channels is 8000 samples per second

7.2. SETTling TIMES FOR TRUE RMS VALUES

We define the settling time as the time required for the TRUE RMS value to reach 99.5% of the full scale in response to an input from 0% to 100% of the Full scale.

For TRUE RMS currents the settling time is 580 ms for TA input with current or voltage output

For TRUE RMS currents the settling time is 700 ms for Rogowski input

For TRUE RMS voltages the settling time is 580 ms.

7.3. ANALOG OUTPUT RESPONSE TIME

Analog Output Response Time: Typical 10 ms (10-90%)

7.4. UPDATE TIMES OF THE REGISTERS RELATING TO THE HARMONIC ANALYSIS (MODBUS PROTOCOL MODELS ONLY)

The individual registers relating to the individual harmonics are updated every 54 seconds.

7.5. UPDATE TIMES OF THE MODBUS REGISTERS (MODBUS PROTOCOL MODELS ONLY)

The measurement update time in Modbus registers is shown in the following table:

Modbus Registers	Typical Modbus Refresh time for Phase L1, L2 and L3 [ms]
Voltage phase to phase L1, L2, L3	560
Voltage phase to neutral L1, L2, L3	115
Current L1, L2, L3, N	115
Active Power L1, L2, L3	115
Reactive Power L1, L2, L3	115

8. MEASUREMENT PRECISION AT 23°C

Type of measurement	Precision at 23°C
Current (TA current output)	0.2% of the measurement with 1000:1 dynamic range
Current (TA voltage output)	0.2% of the measurement with 1000:1 dynamic range
Current (Rogowski)	0.5% of the measurement with 1000:1 dynamic range
Voltage	0.2% of the measurement with 1000:1 dynamic range
Active power (current measurement with current or voltage TA)	0.5% of the measurement with PF=1 and 2000:1 dynamic range
Reactive power (current measurement with TA)	0.5% of the measurement with PF=0 and 2000:1 dynamic range
Active power (current measurement with Rogowski)	0.5% of the measurement with PF=1 and 500:1 dynamic range
Reactive power (current measurement with Rogowski)	0.5% of the measurement with PF=0 and 500:1 dynamic range

9. ROGOWSKI SENSOR INPUT FULL SCALE

INPUT	F.S. 50 Hz (FORM FACTOR 2) [A]	F.S. 60 Hz (FORM FACTOR 2) [A]
ROGOWSKI 1000A/333mV (750A@50Hz)	750	600
ROGOWSKI 1000A/100mV (1250A@50Hz)	1250	1000
ROGOWSKI 1000A/83mV (750A@50Hz)	750	600
ROGOWSKI 1000A/25mV (1250A@50Hz)	1250	1000
ROGOWSKI 1000A/100 mV (2500A@50Hz)	2500	2000
ROGOWSKI 1000A/100 mV (625A@50Hz)	625	500
ROGOWSKI 1000A/100 mV (312A@50Hz)	312	250

10. **DATALOGGER (MODBUS PROTOCOL MODELS ONLY)**

The device has two different data loggers (that can be enabled also simultaneously):

- a configurable sampling time data logger with a maximum speed of 1 sample per second;
- an event data logger, that is, it records the configured event (just one) and the date/time when it occurred;

It is possible to download the data of both data loggers to a device via web server, the format is text separated by commas (csv standard).

10.1. **TIME DATA LOGGER**

The time data logger allows you to store a maximum of 30 variables (tags) in the device's internal flash for a maximum number of 65472 samples each with a maximum of 30 variables.

The sampling time can vary between 1 second (minimum) to 24 h (maximum).

It is also possible to start e stop the data logger through the status of a digital input.

Example of the contents of the time data logger csv file:

```
DATE/TIME;V31_MIN;V2N_AVG_MIN;V2N_AVG_MAX;V3N;V23_AVG_MAX;V3N_MIN;V3N_MAX;V31_AVG_MAX;Vsys;Vsys_AVG;Vsys_MIN;Vsys_MAX;Vsys_AVG_MIN;
2023-12-07-14-52-06;0.000;0.002;0.119;0.085;0.058;0.081;0.089;0.058;0.316;0.058;0.000;0.316;0.000;
2023-12-07-14-52-36;0.000;0.002;0.119;0.084;0.069;0.081;0.090;0.069;0.316;0.069;0.000;0.316;0.000;
2023-12-07-14-53-19;0.000;0.002;0.117;0.086;0.005;0.081;0.089;0.005;0.316;0.005;0.000;0.316;0.000;
2023-12-07-14-53-49;0.000;0.002;0.117;0.085;0.016;0.081;0.089;0.016;0.316;0.016;0.000;0.316;0.000;
2023-12-07-14-54-19;0.000;0.002;0.117;0.085;0.026;0.081;0.089;0.026;0.316;0.026;0.000;0.316;0.000;
2023-12-07-14-54-49;0.000;0.002;0.117;0.087;0.037;0.081;0.090;0.037;0.316;0.037;0.000;0.316;0.000;
2023-12-07-14-55-19;0.000;0.002;0.117;0.085;0.047;0.081;0.090;0.047;0.316;0.047;0.000;0.316;0.000;
2023-12-07-14-55-49;0.000;0.002;0.117;0.086;0.058;0.081;0.090;0.058;0.316;0.058;0.000;0.316;0.000;
2023-12-07-14-56-20;0.000;0.002;0.117;0.085;0.069;0.081;0.090;0.069;0.316;0.069;0.000;0.316;0.000;
2023-12-07-14-56-50;0.000;0.002;0.117;0.086;0.079;0.081;0.090;0.079;0.316;0.079;0.000;0.316;0.000;
2023-12-07-14-57-20;0.000;0.002;0.117;0.086;0.090;0.081;0.090;0.090;0.316;0.090;0.000;0.316;0.000;
2023-12-07-14-57-50;0.000;0.002;0.117;0.085;0.100;0.080;0.090;0.100;0.316;0.100;0.000;0.316;0.000;
2023-12-07-14-58-20;0.000;0.002;0.117;0.085;0.111;0.080;0.090;0.111;0.316;0.111;0.000;0.316;0.000;
2023-12-07-14-58-50;0.000;0.002;0.117;0.082;0.121;0.080;0.090;0.121;0.316;0.121;0.000;0.316;0.000;
2023-12-07-14-59-20;0.000;0.002;0.117;0.083;0.132;0.080;0.090;0.132;0.316;0.132;0.000;0.316;0.000;
2023-12-07-14-59-50;0.000;0.002;0.117;0.083;0.142;0.080;0.090;0.142;0.316;0.142;0.000;0.316;0.000;
```

10.2. **EVENT DATA LOGGER**

If you need to record the date/time of a particular event, you can use the event data logger.

This can record a maximum of 512 samples of a single event with their time tags.

It is possible to define just one event by indicating the variable to be monitored and its threshold (or alarm window).

Example of the contents of the event data logger csv file:

```
DATE/TIME;EVENT TYPE;
2023-12-07-15-24-42;ALARM;
2023-12-07-15-24-45;ALARM RETURN;
2023-12-07-15-24-47;ALARM;
2023-12-07-15-24-49;ALARM RETURN;
```

11. **SMART FUNCTIONS FOR SENDING DATA AND EVENTS TO THE CLOUDS (MODBUS PROTOCOL MODELS ONLY)**

The values acquired by dataloggers can be sent directly to the clouds by choosing between the MQTT(s), Http(s) or FTP protocols.

You can choose to send with a single protocol between Mqtt(s), http(s) or FTP.

MQTT

The MQTT protocol supported is version 3.1.1



The HTTP protocol for tags publication on cloud is based on API Rest

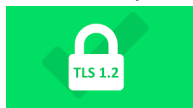

The TLS protocol supported is version 1.2



Keys certifications according to X.509 standard

11.1. **MQTT(s) CLIENT PROTOCOL**

MQTT is the most widely used protocol for IOT applications.

"MQTT" stands for MQ Telemetry Transport. It is an extremely simple and lightweight public/subscription messaging protocol designed for devices with low bandwidth, high latency or unreliable networks. The design principles are to minimize network bandwidth and device resource requirements while trying to ensure reliability and a certain degree of delivery guarantee. These principles prove ideal for the emerging "machine-to-machine" (M2M) or "Internet of Things" world.

For more information on the MQTT protocol see



The MQTT version supported is 3.1.1

Sending via MQTT can be parameterized using a simple syntax, it is also possible to add the timestamp (in date/time minutes seconds or in seconds since 1/1/1970 "epoch" format).

Using Mqtt it is also possible to insert a threshold beyond which data can be sent or not.

11.2. **HTTP(s) POST PROTOCOL**

Communication with the Clouds is possible via HTTP protocol with a POST call.

The data sent to the server is contained in the body of the HTTP request.

Sending via HTTP can be parameterized using a simple syntax, it is also possible to add the timestamp (in date/time minutes seconds or in seconds since 1/1/1970 "epoch" format).

11.3. **FTP CLIENT PROTOCOL**

Data can also be sent to an FTP server.

In this case the logs are sent directly in the csv format produced by the data logger

11.4. **SENDING DATA AND EVENTS WITH OR WITHOUT RECOVERY**

If you set a log sampling time over or equal to 30 seconds, you can activate the recovery function.

In this mode data are sent with the configured sending time but, in the event of a communication hole, anything that has not been sent will be sent at the next connection.

11.5. SENDING COMMANDS TO THE DEVICE VIA MQTT(S) PROTOCOL

The device is compatible with receiving commands via the MQTT(s) protocol.

By default, the subscription topic for commands is configured as follows:

seneca/%c/cmd

Where %c represents the client ID or a unique device identifier, dynamically replaced upon connection.

SUBSCRIBE TOPIC FOR COMMANDS	seneca/%c/cmd	<input type="text" value="seneca/%c/cmd"/>
---	---------------	--

This configuration can be modified via the web interface in the section:

System Connection → MQTT

The MQTT commands supported by the device are as follows:

JSON Hexadecimal Command	JSON Decimal String Command	JSON Decimal Value Command	Expected JSON Command Result
{"value": "0xc1a0"}	{"value": "49568"}	{"value": 49568}	Device Reboot
{"value": "0x105"}	{"value": "261"}	{"value": 261}	Clear energy
{"value": "0x104"}	{"value": "260"}	{"value": 260}	Reset MIN/MAX
{"value": "0x103"}	{"value": "259"}	{"value": 259}	Reset AVG
{"value": "0xA01A"}	{"value": "40986"}	{"value": 40986}	Counter 1 reset
{"value": "0xA02A"}	{"value": "41002"}	{"value": 41002}	Counter 2 reset

Additional command examples for valuing counters in hexadecimal:

Configured value	Counter 1 valuing JSON command in hexadecimal
0	{"value":"0xA01A", "CMD_AUX":"0x0"}
1	{"value":"0xA01A", "CMD_AUX":"0x1"}
2	{"value":"0xA01A", "CMD_AUX":"0x2"}
3	{"value":"0xA01A", "CMD_AUX":"0x3"}
4	{"value":"0xA01A", "CMD_AUX":"0x4"}
5	{"value":"0xA01A", "CMD_AUX":"0x5"}
10	{"value":"0xA01A", "CMD_AUX":"0xA"}
50	{"value":"0xA01A", "CMD_AUX":"0x32"}
100	{"value":"0xA01A", "CMD_AUX":"0x64"}
500	{"value":"0xA01A", "CMD_AUX":"0x1F4"}
1000	{"value":"0xA01A", "CMD_AUX":"0x3E8"}
65535	{"value":"0xA01A", "CMD_AUX":"0xFFFF"}

Configured value	Counter 2 valuing JSON command in hexadecimal
0	{"value":"0xA02A", "CMD_AUX":"0x0"}
1	{"value":"0xA02A", "CMD_AUX":"0x1"}
2	{"value":"0xA02A", "CMD_AUX":"0x2"}
3	{"value":"0xA02A", "CMD_AUX":"0x3"}
4	{"value":"0xA02A", "CMD_AUX":"0x4"}
5	{"value":"0xA02A", "CMD_AUX":"0x5"}
10	{"value":"0xA02A", "CMD_AUX":"0xA"}
50	{"value":"0xA02A", "CMD_AUX":"0x32"}
100	{"value":"0xA02A", "CMD_AUX":"0x64"}
500	{"value":"0xA02A", "CMD_AUX":"0x1F4"}
1000	{"value":"0xA02A", "CMD_AUX":"0x3E8"}
65535	{"value":"0xA02A", "CMD_AUX":"0xFFFF"}

Additional command examples for valuing counters with decimal string:

Configured value	Counter 1 valuing JSON command with decimal string
0	<code>{"value": "40986", "CMD_AUX": "0"}</code>
1	<code>{"value": "40986", "CMD_AUX": "1"}</code>
2	<code>{"value": "40986", "CMD_AUX": "2"}</code>
3	<code>{"value": "40986", "CMD_AUX": "3"}</code>
4	<code>{"value": "40986", "CMD_AUX": "4"}</code>
5	<code>{"value": "40986", "CMD_AUX": "5"}</code>
10	<code>{"value": "40986", "CMD_AUX": "10"}</code>
50	<code>{"value": "40986", "CMD_AUX": "50"}</code>
100	<code>{"value": "40986", "CMD_AUX": "100"}</code>
500	<code>{"value": "40986", "CMD_AUX": "500"}</code>
1000	<code>{"value": "40986", "CMD_AUX": "1000"}</code>
65535	<code>{"value": "40986", "CMD_AUX": "65535"}</code>

Configured value	Counter 2 valuing JSON command with decimal string
0	<code>{"value": "41002", "CMD_AUX": "0"}</code>
1	<code>{"value": "41002", "CMD_AUX": "1"}</code>
2	<code>{"value": "41002", "CMD_AUX": "2"}</code>
3	<code>{"value": "41002", "CMD_AUX": "3"}</code>
4	<code>{"value": "41002", "CMD_AUX": "4"}</code>
5	<code>{"value": "41002", "CMD_AUX": "5"}</code>
10	<code>{"value": "41002", "CMD_AUX": "10"}</code>
50	<code>{"value": "41002", "CMD_AUX": "50"}</code>
100	<code>{"value": "41002", "CMD_AUX": "100"}</code>
500	<code>{"value": "41002", "CMD_AUX": "500"}</code>
1000	<code>{"value": "41002", "CMD_AUX": "1000"}</code>
65535	<code>{"value": "41002", "CMD_AUX": "65535"}</code>

Additional command examples for valuing counters with decimal value:

Configured value	Counter 1 valuing JSON command with decimal value
0	<code>{"value":40986,"CMD_AUX":0}</code>
1	<code>{"value":40986,"CMD_AUX":1}</code>
2	<code>{"value":40986,"CMD_AUX":2}</code>
3	<code>{"value":40986,"CMD_AUX":3}</code>
4	<code>{"value":40986,"CMD_AUX":4}</code>
5	<code>{"value":40986,"CMD_AUX":5}</code>
10	<code>{"value":40986,"CMD_AUX":10}</code>
50	<code>{"value":40986,"CMD_AUX":50}</code>
100	<code>{"value":40986,"CMD_AUX":100}</code>
500	<code>{"value":40986,"CMD_AUX":500}</code>
1000	<code>{"value":40986,"CMD_AUX":1000}</code>
65535	<code>{"value":40986,"CMD_AUX":65535}</code>

Configured value	Counter 2 valuing JSON command with decimal value
0	<code>{"value":41002,"CMD_AUX":0}</code>
1	<code>{"value":41002,"CMD_AUX":1}</code>
2	<code>{"value":41002,"CMD_AUX":2}</code>
3	<code>{"value":41002,"CMD_AUX":3}</code>
4	<code>{"value":41002,"CMD_AUX":4}</code>
5	<code>{"value":41002,"CMD_AUX":5}</code>
10	<code>{"value":41002,"CMD_AUX":10}</code>
50	<code>{"value":41002,"CMD_AUX":50}</code>
100	<code>{"value":41002,"CMD_AUX":100}</code>
500	<code>{"value":41002,"CMD_AUX":500}</code>
1000	<code>{"value":41002,"CMD_AUX":1000}</code>
65535	<code>{"value":41002,"CMD_AUX":65535}</code>

12. CONNECTION OF THE DEVICES TO A NETWORK

12.1. MODBUS, ETHERNET/IP AND OPC-UA PROTOCOLS MODELS

The factory configuration of the IP address is:

Static address: 192.168.90.101

Therefore, multiple devices must not be inserted on the same network with the same static IP.

If you want to connect multiple devices on the same network, you need to change the IP address configuration (for instance using the Seneca Discovery Device software).



**DO NOT CONNECT 2 OR MORE FACTORY-CONFIGURED DEVICES ON THE SAME NETWORK, OR THE ETHERNET INTERFACE WILL NOT WORK
(CONFLICT OF IP ADDRESSES 192.168.90.101)**

If the addressing mode with DHCP is activated and an IP address is not received within 1 minute, the device will set an IP address with a fixed error:

169.254.x.y

Where x.y are the last two values of the MAC ADDRESS.

This way it is possible to install more I/O of the R series and then configure the IP Address even on networks without a DHCP server.

12.2. *PROFINET IO PROTOCOL MODELS*

Profinet IO devices are supplied without an IP address.

 **ATTENTION!**

PROFINET IO PROTOCOL DEVICES ARE SUPPLIED WITHOUT AN IP ADDRESS (0.0.0.0).

MORE DEVICES CAN THEREFORE BE INSERTED INTO THE SAME PROFINET NETWORK AND IDENTIFIED THROUGH SCAN OF THE PROFINET NETWORK ITSELF

TO SET AN IP ADDRESS (FOR EXAMPLE TO ACCESS THE WEBSERVER) USE THE PROFINET CONFIGURATION ENVIRONMENT OR FORCE THE ADDRESS 192.168.90.101 WITH THE APPROPRIATE DIP SWITCH

13. I/O COPY USING THE PEER TO PEER FUNCTION WITHOUT WIRING (MODBUS PROTOCOL MODELS ONLY)

The "R" series devices can be used to copy and update in real time an input channel on a remote output channel without the aid of a master controller.

For example, a digital input can be copied to a remote digital output device:



Note that no controller is required because the communication is managed directly by the R series devices. It is possible to make a more sophisticated connection, for example it is possible to copy the inputs to different R-series remote devices (from Device 1 Input 1 to Device 2 Output1, Device 1 Input 2 to Device 3 Output 1 etc ...)

It is also possible to copy an input to an output of multiple remote devices:

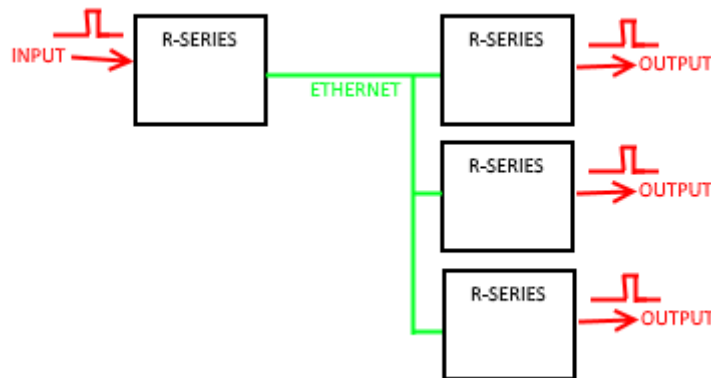

Each R-series device can send and receive a maximum of 32 inputs.

14. WEB SERVER

14.1. ACCESS TO THE WEB SERVER

The web server can be accessed using a web browser by directly typing the device's IP address. By default, the device is configured to use the HTTP protocol. HTTPS is not enabled by default.

To find the IP address, use the "search" function in the "Easy Setup 2" software or the "Seneca Discovery Device" software.

Using the factory configuration (be careful about the model you purchased; for example, for -P models, you need to force the IP using a dip switch), you have:

http://192.168.90.101

The first time you log in, you will be prompted for your username and password.

The default values are:

User Name: admin

Password: admin

In the web server, in the "System Settings" section, there is an option that allows you to enable or disable the HTTPS connection with TLS protocol.

WEBSERVER TYPE	HTTP	HTTP ▾
WEBSERVER PORT	80	HTTPS <input type="text"/>
<input type="button" value="FACTORY DEFAULT"/>		<input type="button" value="APPLY"/>

After enabling HTTPS, the device will only be accessible via an encrypted connection. Access must therefore be made using, for example, the following URL:

https://192.168.90.101

ATTENTION!

AFTER THE FIRST ACCESS CHANGE USER NAME AND PASSWORD IN ORDER TO PREVENT ACCESS TO THE DEVICE TO UNAUTHORIZED PEOPLE.

ATTENTION!

IF THE PARAMETERS TO ACCESS THE WEB SERVER HAVE BEEN LOST, IT IS NECESSARY TO RESET THE CONFIGURATION TO DEFAULT USING THE DIP-SWITCHES

 **ATTENTION!**

IN R203-P AND R204-P DEVICES, BEFORE ACCESSING THE WEB SERVER, DISCONNECT THE DEVICE FROM THE IO PROFINET NETWORK

15. CONNECTION DIAGNOSTICS

The device includes advanced connection diagnostics available on the webserver and on communication protocols.

If the system detects a connection error, the WIRING ERROR LED will flash, at this point it is possible to check the reason for the error:

VOLTAGE CYCLIC DIRECTION If it is "Wrong" it indicates that the connection of the voltmeters does not comply with the cyclic direction R (L1) -> S (L2) -> T (L3). To solve the problem, wire the voltage inputs again.

If it is "Correct" go to the next item. This is not a real connection error (and therefore does not cause the WIRING ERROR LED to flash).

 **ATTENTION!**

IGNORE THE VOLTAGE CYCLIC DIRECTION ERROR INDICATION IN CASE OF CONNECTION WITH ARON INSERTION

CURRENT L1..L3 If it is "STRAIGHT" it indicates that the TA relating to the i-th input is connected correctly. If it is "INVERTED" it indicates that the TA relating to the i-th input is reversed (reverse the wiring of the TA terminals). When the three currents are "STRAIGHT" it is possible to move on to the next item.

 **ATTENTION!**

IF THE DEVICE IS CONNECTED TO A GENERATOR, IT IS CORRECT THAT CURRENT L1..L3 ARE ALL "INVERTED".
IN THIS CASE, THE WORD "PRODUCTION" WILL APPEAR IN THE "ENERGY" FIELD .

L1..L3 CONNECTION If this parameter is "CORRECT" it means that the L-i th current input and the L-i th voltage input have been wired correctly.

In the case of "ERROR" it means that, for example the Li-th phase of the current does not coincide with the Li-th voltage phase, therefore a wiring error of the ammeters or voltmeters (for example the current L1 has been connected to the current input L2).

It is, in fact, possible to wire complying with the cyclic direction of the voltages and the correct direction of the TAs but have no correspondence between the voltage and current phases.

In this case, wire the device again (for example, it is possible to move the voltmeters by 1 position, always complying with the cyclic direction until this error disappears).

In the case of non-standard installation configurations, a parameter can be configured to ignore the diagnostics.

16. **DEVICE CONFIGURATION VIA WEBSERVER (MODBUS PROTOCOL MODELS ONLY)**

To configure the device, access the web server and select the section you are interested in.

After a modification to the configuration has been made, the changes must be confirmed with the "**APPLY**" button entering the administrator account and password.

The **Reboot** button reboots the device (not necessary in the event of a configuration change).

The **Default** button returns all the page parameters to the default settings.

16.1. **MEASURES SECTION -> MEASURES SETUP**

CONNECTION TYPE

Sets the type of connection to make.

CT TYPE

Selects the type of sensor and the value of the TA secondary to be used between:

TA with current output

TA with MV output

Rogowski sensor

CT RATIO

Sets any TA ratio, the value to enter is related to the primary, example:

If a 50/5 TA has been installed, the value 50 must be entered as primary with the value 5 on the "TA TYPE" parameter.

VT TYPE

Sets the type of voltage transformer

NETWORK FREQUENCY [Hz]

Set the system to 50 or 60 Hz, this parameter is not important since the device adapts to the network frequency autonomously.

AVERAGE POWER WINDOW

Sets the time on which to measure the average values

USER CALIBRATION VOLTAGE

Sets a possible multiplication coefficient for the voltage measurement.

USER CALIBRATION CURRENT

Sets a possible multiplication coefficient for the current measurement.

CUTOFF CURRENT [A]

Sets a current value (on the primary) below which counters are stopped.

USER CALIBRATION ACTIVE ENERGY

Sets a possible multiplication coefficient for the active energy.

USER CALIBRATION REACTIVE ENERGY

Sets a possible multiplication coefficient for the reactive energy.

ANALOG OUTPUT TYPE

Selects the type of analog output between voltage and current

16.2. **MEASURES SECTION ->ENERGY TOTALIZER SETUP**

Allows you to set the starting values of the various counters of the device.

16.3. **DATALOGGER SECTION-> SETUP DATALOGGER**

EVENT MODE

Selects the maximum, minimum or window alarm event.

RETURN EVENT

Enables or not also the alarm exit event

EVENT SOURCE

Selects the variable to use for the alarm event

EVENT HIGH THRESHOLD

Sets the threshold representing the high alarm event.

EVENT LOW THRESHOLD

Sets the threshold representing the low alarm event.

HYSTERESIS

Represents the event hysteresis

DATA LOGGER SAMPLE TIME

Enables/Disables and sets the sampling time for the timed data logger. This will also be the send time for MQTT and http connections.

DATA RECOVERY

If the sample time is ≥ 30 s it is possible to choose whether the sending of data must take place with or without recovery in case of momentary lack of communication.

DATA LOGGER CONNECTOR

Allows you to choose whether to send data via MQTT, HTTP or FTP protocols.

DATA LOGGER SOURCE 1...30

Selects the i-th variable to be entered in the timed data logger.

16.4. **SYSTEM SETTINGS SECTION -> SYSTEM SETTINGS**

PROTECT CONFIGURATION (default: Disabled)

Allows you to enable or not the device IP configuration from the Seneca Discovery software

ADMIN ACCOUNT NAME

This is the name of the administrator account, the administrator can view and configure the device.

ADMIN ACCOUNT PASSWORD

This is the password of the administrator account.

OPERATOR ACCOUNT NAME

This is the name of the operator account, the operator can view and modify the configuration but cannot change the measurement parameters.

OPERATOR ACCOUNT PASSWORD

This is the password of the operator account.

VIEWER ACCOUNT NAME

This is the name of the account viewer, the viewer can only view the configuration

VIEWER ACCOUNT PASSWORD

This is the password of the viewer account.

WEBSERVER PORT

This is the webservice port

16.5. SYSTEM SETTINGS SECTION -> SYSTEM ETHERNET**DHCP (ETH) (default: Disabled)**

Sets the DHCP client to get an IP address automatically.

IP ADDRESS STATIC (ETH) (default: 192.168.90.101)

Sets the device static address. Careful not to enter devices with the same IP address into the same network.

IP MASK STATIC (ETH) (default: 255.255.255.0)

Sets the mask for the IP network.

GATEWAY ADDRESS STATIC (ETH) (default: 192.168.90.1)

Sets the gateway address.

DNS (default: 8.8.8.8)

Set the Domain Name System.

16.6. SYSTEM SETTINGS SECTION -> SYSTEM TIME**DATE/TIME SYNC WITH NTP SERVER**

Selects whether the time should be synchronized with NTP servers

DATE/TIME SYNC MODE

Selects how often to synchronize the date/time

NTP SERVER IP ADDRESS 1

Sets the first NTP server

NTP SERVER IP ADDRESS 2

Sets the second NTP server (backup)

TIME ZONE

Sets the Timezone

DAYLIGHT SAVING TIME

Sets whether or not to activate the switchover to winter/summer time

16.7. SYSTEM CONNECTION SECTION -> MODBUS**SERVER PORT (ETH) (default: 502)**

Sets the communication port for the Modbus TCP-IP server.

SERVER STATION ADDRESS (ETH) (default: 1)

Active only if Modbus Passthrough is also active, it sets the station address of the modbus TCP-IP server.

 **ATTENTION!**

THE MODBUS SERVER WILL ANSWER ANY STATION ADDRESS ONLY IF THE MODBUS PASSTHROUGH MODE IS DISABLED.

MODBUS PASSTHROUGH (ETH) (default: disabled)

Sets the conversion mode from Modbus TCP-IP to Modbus RTU serial (see chapter 14).

MODBUS TCP-IP CONNECTION TIMEOUT [sec] (ETH) (default: 60)

Sets the TCP-IP connection timeout for the Modbus TCP-IP server and Passthrough modes.

BAUDRATE MODBUS RTU (SER) (default: 38400 baud)

Sets the baud rate for the RS485 communication port.

DATA MODBUS RTU (SER) (default: 8 bit)

Sets the number of bits for the RS485 communication port.

PARITY MODBUS RTU (SER) (default: None)

Sets the parity for the RS485 communication port.

STOP BIT MODBUS RTU (SER) (default: 1 bit)

Sets the number of stop bits for the RS485 communication port.

MODBUS PASSTHROUGH SERIAL TIMEOUT (default: 100ms)

Active only if passthrough mode is activated, sets the maximum waiting time before sending a new packet from TCP-IP to the serial port. It must be set according to the longest response time of all the devices present on the RS485 serial port.

16.8. **SYSTEM CONNECTION SECTION -> FTP**

In this section the timed sending of logs to an FTP server can be configured. The sending of the logs takes place without encryption.

By pressing the “**FTP SEND NOW**” button a log file is forced to be sent, it will be possible to test the operation of the data entered.

DATALOGGER SENDING

Here you can select the frequency of the log sending, in the case of weekly sending you can also choose which days and at what time to send.

FTP SERVER

Sets the IP address or FTP server name.

SERVER PORT

Sets the server FTP port

USER NAME

Sets the user name to access the server FTP

PASSWORD

Sets the password to access the server FTP

FOLDER

Sets the folder to write logs to (leave blank for root)

DEVICE NAME

Sets the name you want to give to the device, this will be the initial part of the file name on the server.

ATTENTION!

IN THE EVENT OF LACK OF CONNECTION WITH THE FTP SERVER, THE DEVICE WILL CONTINUE TO RECORD THE LOGS AS LONG AS THERE IS SPACE IN THE MEMORY. WHEN THE CONNECTION RESUMES, IT WILL SEND THE LOGS NOT YET SENT IN A SINGLE FILE.

ATTENTION!

THE FORMAT OF THE FILES SENT IS THE SAME AS THAT OBTAINED BY DOWNLOADING THE TIME DATABASE FROM THE WEB SERVER (CSV FORMAT).

16.9. **SYSTEM CONNECTION SECTION -> MQTT**

CUSTOM CLOUD

If the MQTT cloud protocol is selected, you can choose between the clouds:

None, Direl, ONBOARD or Seneca CloudBox2

None: Through the device's MQTT configurability, it is possible to connect to virtually any cloud

Direl ADM: Sets up the device to connect to the Direl ADM cloud

On-Board: Sets up the device to connect to the On-Board cloud

Seneca Cloudbox 2: Sets up the device to connect to the Seneca Cloudbox2 cloud

To add other clouds to the list, you can make a request to Seneca.

MAX FAILURE COUNTER

It is the maximum number of attempts without a pause before declaring a transmission fail.

WAIT AFTER FAILURE (minutes)

It is the pause in minutes before trying to connect again

CLIENT ID

The Client ID is a unique identifier that distinguishes each MQTT client device or application connected to the broker. It must be unique for each simultaneous connection to the same MQTT broker.

BROKER HOST

Specifies the address (hostname or IP address) of the MQTT server (broker) the client should connect to.

BROKER PORT

Specifies the broker port to connect to

USE WEBSOCKETS

Allows you to activate MQTT communication via Websockets

KEEP ALIVE INTERVAL [s]

This parameter defines Keep alive which ensures that the connection between the broker and client is still open and that the broker and client are aware that they are connected. When the client establishes a connection to the broker, it tells the broker a time interval in seconds. This interval defines the maximum period of time during which the broker and client may not communicate with each other.

CLEAN SESSION

This parameter defines the "clean session". When the clean session flag is set to true, the client does not want a persistent session. If the client disconnects for any reason, all information and messages queued from a previous session are lost.

MESSAGE RETAIN

Usually if a publisher publishes a message on a topic to which no one is subscribed, the message is simply discarded by the broker. However, the publisher can tell the broker to keep the last message of that topic.

QUALITY OF SERVICE [QOS]

This parameter defines the QOS of the MQTT protocol.

Can be selected from

QOS 0 (once only, without ack)

QOS 1 (at least once, with ack)

QOS 2 (once only, with ack and resend)

AUTHENTICATION

This parameter defines whether user/password authentication should be used to access the cloud

AUTHENTICATION USER

Broker or server username

AUTHENTICATION PASSWORD

Broker or server password

SSL/TLS

Defines whether to enable the SSL/TLS 1.2 encrypted security protocol

CLIENT CERTIFICATE REQUIRED

Defines whether to manage x.509 certificates for the SSL/TLS connection

CLIENT CERTIFICATE VALIDITY CHECK

If activated, it verifies the certificates are valid

LOG ON CHANGE

Updates values on broker or server only upon change and no longer over time

PUBLISH MULTIPLE TAGS

This parameter defines whether the publish contains multiple tags or whether the device should send a publish for each tag.

PUBLISH TOPIC FOR LOGS

Selects the topic name for the logs using the following table:

%c	Device Client ID
%m	Device MAC Address
%M	Device MAC Address without dot separator
%j[field]	Adds double quotes " to [field]. The double quotes represent a string in JSON

For example:

If:

Device Client ID = Padova13

Publish Topic for Logs = Seneca/%c/data

The data logs will be sent to the topic:Seneca/Padova13/data

PUBLISH PAYLOAD FOR LOGS

Selects the format to be used for the payload of the data datalogger using the following table:

%c	Device Client ID
%m	Device MAC Address

%M	Device MAC Address without dots
%d	date-time
%t	timestamp (number of seconds from 01/01/1970)
%u	timestamp (number of milliseconds from 01/01/1970)
%b	bulk (format specified in "Publish Bulk Format")
%f	Inserts an ID instead of the variable name (see table)
%n	Tag name (only for "Publish Bulk Format")
%v	Tag value (only in "Publish Bulk Format")
%j[field]	Adds double quotes " to [field]. The double quotes represent a string in JSON

Note: the %f placeholder adds a unique ID to the variable to be published according to the following table:

%f (ID)	VARIABLE	EXPLANATION	TIPO
1	V1N	Voltage between Phase 1 and neutral	READ
2	V1N_AVG	Phase 1 to Neutral Voltage (in demand time)	READ
3	V1N_MIN	Minimum voltage between Phase 1 and neutral (from switch-on)	READ
4	V1N_MAX	Maximum voltage between Phase 1 and neutral (from switch-on)	READ
5	V1N_AVG_MIN	Phase 1 to minimum neutral voltage (in demand time)	READ
6	V1N_AVG_MAX	Phase 1 to maximum neutral voltage (in demand time)	READ
7	V2N	Voltage between Phase 2 and neutral	READ
8	V2N_AVG	Phase 2 to Neutral Voltage (in demand time)	READ
9	V2N_MIN	Minimum voltage between Phase 2 and neutral (from switch-on)	READ
10	V2N_MAX	Maximum voltage between Phase 2 and neutral (from switch-on)	READ
11	V2N_AVG_MIN	Phase 2 to minimum neutral voltage (in demand time)	READ
12	V2N_AVG_MAX	Phase 2 to maximum neutral voltage (in demand time)	READ
13	V3N	Voltage between Phase 3 and neutral	READ
14	V3N_AVG	Phase 3 to Neutral Voltage (in demand time)	READ
15	V3N_MIN	Minimum voltage between Phase 3 and neutral (from switch-on)	READ
16	V3N_MAX	Maximum voltage between Phase 3 and neutral (from switch-on)	READ
17	V3N_AVG_MIN	Phase 3 to minimum neutral voltage (in demand time)	READ
18	V3N_AVG_MAX	Phase 3 to maximum neutral voltage (in demand time)	READ
19	AN	Neutral Current	READ
20	AN_AVG	Neutral Current (on demand time)	READ
21	AN_MIN	Minimum neutral current (from switch-on)	READ
22	AN_MAX	Maximum neutral current (from switch-on)	READ

23	AN_AVG_MIN	Minimum neutral current (in demand time)	READ
24	AN_AVG_MAX	Maximum neutral current (in demand time)	READ
25	V12	Phase-to-phase voltage between Phase 1 and 2	READ
26	V12_AVG	Phase-to-phase voltage between Phase 1 and 2 (in demand time)	READ
27	V12_MIN	Minimum phase-to-phase voltage between Phase 1 and 2 (from switch-on)	READ
28	V12_MAX	Maximum phase-to-phase voltage between Phase 1 and 2 (from switch-on)	READ
29	V12_AVG_MIN	Phase-to-phase voltage between minimum Phase 1 and 2 (in demand time)	READ
30	V12_AVG_MAX	Phase-to-phase voltage between maximum Phase 1 and 2 (in demand time)	READ
31	V23	Phase-to-phase voltage between Phase 2 and 3	READ
32	V23_AVG	Phase-to-phase voltage between Phase 2 and 3 (in demand time)	READ
33	V23_MIN	Minimum phase-to-phase voltage between Phase 2 and 3 (from switch-on)	READ
34	V23_MAX	Maximum phase-to-phase voltage between Phase 2 and 3 (from switch-on)	READ
35	V23_AVG_MIN	Phase-to-phase voltage between minimum Phase 2 and 3 (in demand time)	READ
36	V23_AVG_MAX	Phase-to-phase voltage between maximum Phase 2 and 3 (in demand time)	READ
37	V31	Phase-to-phase voltage between Phase 3 and 1	READ
38	V31_AVG	Phase-to-phase voltage between Phase 3 and 1 (in demand time)	READ
39	V31_MIN	Minimum phase-to-phase voltage between Phase 3 and 1 (from switch-on)	READ
40	V31_MAX	Maximum phase-to-phase voltage between Phase 3 and 1 (from switch-on)	READ
41	V31_AVG_MIN	Phase-to-phase voltage between minimum Phase 3 and 1 (in demand time)	READ
42	V31_AVG_MAX	Phase-to-phase voltage between maximum Phase 3 and 1 (in demand time)	READ
43	Vsys	System voltage:	READ
44	Vsys_AVG	System voltage (in demand time)	READ
45	Vsys_MIN	Minimum system voltage (from switch-on)	READ
46	Vsys_MAX	Maximum system voltage (from switch-on)	READ
47	Vsys_AVG_MIN	Minimum system voltage (in demand time)	READ
48	Vsys_AVG_MAX	Maximum system voltage (in demand time)	READ
49	A1	Phase 1 current	READ
50	A1_AVG	Phase 1 current (in demand time)	READ
51	A1_MIN	Minimum Phase 1 current (from switch-on)	READ
52	A1_MAX	Maximum Phase 1 current (from switch-on)	READ
53	A1_AVG_MIN	Minimum Phase 1 current (in demand time)	READ
54	A1_AVG_MAX	Maximum Phase 1 current (in demand time)	READ

55	A2	Phase 2 current	READ
56	A2_AVG	Phase 2 current (in demand time)	READ
57	A2_MIN	Minimum Phase 2 current (from switch-on)	READ
58	A2_MAX	Maximum Phase 2 current (from switch-on)	READ
59	A2_AVG_MIN	Minimum Phase 2 current (in demand time)	READ
60	A2_AVG_MAX	Maximum Phase 2 current (in demand time)	READ
61	A3	Phase 3 current	READ
62	A3_AVG	Phase 3 current (in demand time)	READ
63	A3_MIN	Minimum Phase 3 current (from switch-on)	READ
64	A3_MAX	Maximum Phase 3 current (from switch-on)	READ
65	A3_AVG_MIN	Minimum Phase 3 current (in demand time)	READ
66	A3_AVG_MAX	Maximum Phase 3 current (in demand time)	READ
67	Asys	System current	READ
68	Asys_AVG	System current (in demand time)	READ
69	Asys_MIN	Minimum system current (from switch-on)	READ
70	Asys_MAX	Maximum system current (from switch-on)	READ
71	Asys_AVG_MIN	Minimum system current (in demand time)	READ
72	Asys_AVG_MAX	Maximum system current (in demand time)	READ
73	P1	Phase 1 Active power	READ
74	P1_AVG	Phase 1 active power (in demand time)	READ
75	P1_MIN	Minimum Phase 1 active power (from switch-on)	READ
76	P1_MAX	Maximum Phase 1 active power (from switch-on)	READ
77	P1_AVG_MIN	Minimum Phase 1 active power (in demand time)	READ
78	P1_AVG_MAX	Maximum Phase 1 active power (in demand time)	READ
79	P2	Phase 2 Active power	READ
80	P2_AVG	Phase 2 active power (in demand time)	READ
81	P2_MIN	Minimum Phase 2 active power (from switch-on)	READ
82	P2_MAX	Maximum Phase 2 active power (from switch-on)	READ
83	P2_AVG_MIN	Minimum Phase 2 active power (in demand time)	READ
84	P2_AVG_MAX	Maximum Phase 2 active power (in demand time)	READ
85	P3	Phase 3 Active power	READ
86	P3_AVG	Phase 3 active power (in demand time)	READ
87	P3_MIN	Minimum Phase 3 active power (from switch-on)	READ
88	P3_MAX	Maximum Phase 3 active power (from switch-on)	READ
89	P3_AVG_MIN	Minimum Phase 3 active power (in demand time)	READ
90	P3_AVG_MAX	Maximum Phase 3 active power (in demand time)	READ
91	Psys	System Active power	READ
92	Psys_AVG	System active power (in demand time)	READ
93	Psys_MIN	Minimum system active power (from switch-on)	READ
94	Psys_MAX	Maximum system active power (from switch-on)	READ
95	Psys_AVG_MIN	Minimum system active power (in demand time)	READ
96	Psys_AVG_MAX	Maximum system active power (in demand time)	READ
97	S1	Phase 1 apparent power	READ

98	S1_AVG	Phase 1 apparent power (in demand time)	READ
99	S1_MIN	Minimum Phase 1 apparent power (from switch-on)	READ
100	S1_MAX	Maximum Phase 1 apparent power (from switch-on)	READ
101	S1_AVG_MIN	Minimum Phase 1 apparent power (in demand time)	READ
102	S1_AVG_MAX	Maximum Phase 1 apparent power (in demand time)	READ
103	S2	Phase 2 apparent power	READ
104	S2_AVG	Phase 2 apparent power (in demand time)	READ
105	S2_MIN	Minimum Phase 2 apparent power (from switch-on)	READ
106	S2_MAX	Maximum Phase 2 apparent power (from switch-on)	READ
107	S2_AVG_MIN	Minimum Phase 2 apparent power (in demand time)	READ
108	S2_AVG_MAX	Maximum Phase 2 apparent power (in demand time)	READ
109	S3	Phase 3 apparent power	READ
110	S3_AVG	Phase 3 apparent power (in demand time)	READ
111	S3_MIN	Minimum Phase 3 apparent power (from switch-on)	READ
112	S3_MAX	Maximum Phase 3 apparent power (from switch-on)	READ
113	S3_AVG_MIN	Minimum Phase 3 apparent power (in demand time)	READ
114	S3_AVG_MAX	Maximum Phase 3 apparent power (in demand time)	READ
115	Ssys	System apparent power	READ
116	Ssys_AVG	System apparent power (in demand time)	READ
117	Ssys_MIN	Minimum system apparent power (from switch-on)	READ
118	Ssys_MAX	Maximum system apparent power (from switch-on)	READ
119	Ssys_AVG_MIN	Minimum system apparent power (in demand time)	READ
120	Ssys_AVG_MAX	Maximum system apparent power (in demand time)	READ
121	Q1	Phase 1 Reactive power	READ
122	Q1_AVG	Phase 1 reactive power (in demand time)	READ
123	Q1_MIN	Minimum Phase 1 reactive power (from switch-on)	READ
124	Q1_MAX	Maximum Phase 1 reactive power (from switch-on)	READ
125	Q1_AVG_MIN	Minimum Phase 1 reactive power (in demand time)	READ
126	Q1_AVG_MAX	Maximum Phase 1 reactive power (in demand time)	READ
127	Q2	Phase 2 Reactive power	READ
128	Q2_AVG	Phase 2 reactive power (in demand time)	READ
129	Q2_MIN	Minimum Phase 2 reactive power (from switch-on)	READ
130	Q2_MAX	Maximum Phase 2 reactive power (from switch-on)	READ
131	Q2_AVG_MIN	Minimum Phase 2 reactive power (in demand time)	READ
132	Q2_AVG_MAX	Maximum Phase 2 reactive power (in demand time)	READ
133	Q3	Phase 3 Reactive power	READ
134	Q3_AVG	Phase 3 reactive power (in demand time)	READ
135	Q3_MIN	Minimum Phase 3 reactive power (from switch-on)	READ
136	Q3_MAX	Maximum Phase 3 reactive power (from switch-on)	READ
137	Q3_AVG_MIN	Minimum Phase 3 reactive power (in demand time)	READ
138	Q3_AVG_MAX	Maximum Phase 3 reactive power (in demand time)	READ
139	Qsys	System Reactive power	READ
140	Qsys_AVG	System reactive power (in demand time)	READ

141	Qsys_MIN	Minimum system reactive power (from switch-on)	READ
142	Qsys_MAX	Maximum system reactive power (from switch-on)	READ
143	Qsys_AVG_MIN	Minimum system reactive power (in demand time)	READ
144	Qsys_AVG_MAX	Maximum system reactive power (in demand time)	READ
145	TPF1	Phase 1 Power factor	READ
146	TPF1_AVG	Phase 1 power factor (in demand time)	READ
147	TPF1_MIN	Minimum Phase 1 power factor (from switch-on)	READ
148	TPF1_MAX	Maximum Phase 1 power factor (from switch-on)	READ
149	TPF1_AVG_MIN	Minimum Phase 1 power factor (in demand time)	READ
150	TPF1_AVG_MAX	Maximum Phase 1 power factor (in demand time)	READ
151	TPF2	Phase 2 Power factor	READ
152	TPF2_AVG	Phase 2 power factor (in demand time)	READ
153	TPF2_MIN	Minimum Phase 2 power factor (from switch-on)	READ
154	TPF2_MAX	Maximum Phase 2 power factor (from switch-on)	READ
155	TPF2_AVG_MIN	Minimum Phase 2 power factor (in demand time)	READ
156	TPF2_AVG_MAX	Maximum Phase 2 power factor (in demand time)	READ
157	TPF3	Phase 3 Power factor	READ
158	TPF3_AVG	Phase 3 power factor (in demand time)	READ
159	TPF3_MIN	Minimum Phase 3 power factor (from switch-on)	READ
160	TPF3_MAX	Maximum Phase 3 power factor (from switch-on)	READ
161	TPF3_AVG_MIN	Minimum Phase 3 power factor (in demand time)	READ
162	TPF3_AVG_MAX	Maximum Phase 3 power factor (in demand time)	READ
163	TPFsys	System Power factor	READ
164	TPFsys_AVG	System power factor (in demand time)	READ
165	TPFsys_MIN	Minimum system power factor (from switch-on)	READ
166	TPFsys_MAX	Minimum system power factor (from switch-on)	READ
167	TPFsys_AVG_MIN	Minimum system power factor (in demand time)	READ
168	TPFsys_AVG_MAX	Maximum system power factor (in demand time)	READ
169	THD-V1N	Voltage THD (Total Harmonic Distortion) between Phase 1 and neutral	READ
170	THD-V1N_AVG	Voltage THD between Phase 1 and neutral (in demand time)	READ
171	THD-V1N_MIN	Minimum voltage THD between Phase 1 and neutral (from switch-on)	READ
172	THD-V1N_MAX	Maximum voltage THD between Phase 1 and neutral (from switch-on)	READ
173	THD-V1N_AVG_MIN	Minimum voltage THD between Phase 1 and neutral (in demand time)	READ
174	THD-V1N_AVG_MAX	Maximum voltage THD between Phase 1 and neutral (in demand time)	READ
175	THD-V2N	Voltage THD between Phase 2 and neutral	READ
176	THD-V2N_AVG	Voltage THD between Phase 2 and neutral (in demand time)	READ
177	THD-V2N_MIN	Minimum voltage THD between Phase 2 and neutral (from switch-on)	READ
178	THD-V2N_MAX	Maximum voltage THD between Phase 2 and neutral (from switch-on)	READ

179	THD-V2N_AVG_MIN	Minimum voltage THD between Phase 2 and neutral (in demand time)	READ
180	THD-V2N_AVG_MAX	Maximum voltage THD between Phase 2 and neutral (in demand time)	READ
181	THD-V3N	Voltage THD between Phase 3 and neutral	READ
182	THD-V3N_AVG	Voltage THD between Phase 3 and neutral (in demand time)	READ
183	THD-V3N_MIN	Minimum voltage THD between Phase 3 and neutral (from switch-on)	READ
184	THD-V3N_MAX	Maximum voltage THD between Phase 3 and neutral (from switch-on)	READ
185	THD-V3N_AVG_MIN	Minimum voltage THD between Phase 3 and neutral (in demand time)	READ
186	THD-V3N_AVG_MAX	Maximum voltage THD between Phase 3 and neutral (in demand time)	READ
187	f	Phase frequency (read from Phase 1)	READ
188	THD-A1N	Phase 1 current THD	READ
189	THD-A1N_AVG	Phase 1 current THD (in demand time)	READ
190	THD-A1N_MIN	Minimum Phase 1 current THD (from switch-on)	READ
191	THD-A1N_MAX	Maximum Phase 1 current THD (from switch-on)	READ
192	THD-A1N_AVG_MIN	Minimum Phase 1 current THD (in demand time)	READ
193	THD-A1N_AVG_MAX	Maximum Phase 1 current THD (in demand time)	READ
194	THD-A2N	Phase 2 current THD	READ
195	THD-A2N_AVG	Phase 2 current THD (in demand time)	READ
196	THD-A2N_MIN	Minimum Phase 2 current THD (from switch-on)	READ
197	THD-A2N_MAX	Maximum Phase 2 current THD (from switch-on)	READ
198	THD-A2N_AVG_MIN	Minimum Phase 2 current THD (in demand time)	READ
199	THD-A2N_AVG_MAX	Maximum Phase 2 current THD (in demand time)	READ
200	THD-A3N	Phase 3 current THD	READ
201	THD-A3N_AVG	Phase 3 current THD (in demand time)	READ
202	THD-A3N_MIN	Minimum Phase 3 current THD (from switch-on)	READ
203	THD-A3N_MAX	Maximum Phase 3 current THD (from switch-on)	READ
204	THD-A3N_AVG_MIN	Minimum Phase 3 current THD (in demand time)	READ
205	THD-A3N_AVG_MAX	Maximum Phase 3 current THD (in demand time)	READ
206	+WH1	Phase 1 positive active energy	READ
207	+WH2	Phase 2 positive active energy	READ
208	+WH3	Phase 3 positive active energy	READ
209	+Wh	Total positive active energy	READ
210	-WH1	Phase 1 negative active energy	READ
211	-WH2	Phase 2 negative active energy	READ
212	-WH3	Phase 3 negative active energy	READ

213	-Wh	Total negative active energy	READ
214	VAh1	Phase 1 apparent energy	READ
215	VAh2	Phase 2 apparent energy	READ
216	VAh3	Phase 3 apparent energy	READ
217	VAh	Total apparent energy	READ
218	+VARh1-L[Q1]	Phase 1 positive inductive reactive energy (Q1)	READ
219	+VARh2-L[Q1]	Phase 2 positive inductive reactive energy (Q1)	READ
220	+VARh3-L[Q1]	Phase 3 positive inductive reactive energy (Q1)	READ
221	+VARh-L[Q1]	Total positive inductive reactive energy (Q1)	READ
222	-VARh1-C[Q4]	Phase 1 negative capacitive reactive energy (Q4)	READ
223	-VARh2-C[Q4]	Phase 2 negative capacitive reactive energy (Q4)	READ
224	-VARh3-C[Q4]	Phase 3 negative capacitive reactive energy (Q4)	READ
225	-VARh-C[Q4]	Total negative capacitive reactive energy (Q4)	READ
226	-VARh1-L[Q3]	Phase 1 negative inductive reactive energy (Q3)	READ
227	-VARh2-L[Q3]	Phase 2 negative inductive reactive energy (Q3)	READ
228	-VARh3-L[Q3]	Phase 3 negative inductive reactive energy (Q3)	READ
229	-VARh-L[Q3]	Total negative inductive reactive energy (Q3)	READ
230	+VARh1-C[Q2]	Phase 1 positive capacitive reactive energy (Q2)	READ
231	+VARh2-C[Q2]	Phase 2 positive capacitive reactive energy (Q2)	READ
232	+VARh3-C[Q2]	Phase 3 positive capacitive reactive energy (Q2)	READ
233	+VARh-C[Q2]	Total positive capacitive reactive energy (Q2)	READ
234	Wh	Total active energy	READ
235	VARh	Total reactive energy	READ
236	VARh-L[Q1Q3]	Total inductive reactive energy (Q1+Q3)	READ
237	VARh-C[Q2Q4]	Total capacitive reactive energy (Q2+Q4)	READ
238	VAh	Total apparent energy	READ
239	COUNTER 1	Input 1 pulse counter	READ
240	COUNTER 2	Input 2 pulse counter	READ
241	DIGITAL_IN_1	Digital Input 1	READ
242	DIGITAL_IN_2	Digital Input 2	READ
243	DIGITAL_OUT_1	Digital output 1	READ/ WRITE
244	DIGITAL_OUT_2	Digital output 2	READ/ WRITE
245	ANALOG OUT	Value to load on analog output (R203 models only) in uA or mV	READ/ WRITE
246	COMMAND	Command register. Supported commands: 260 decimal to reset MIN/MAX 259 decimal to reset AVG demand time values 261 decimal to reset Energy Counters	READ/ WRITE
247	TOT KVARh L1	Phase 1 total reactive energy	READ
248	TOT KVARh L2	Phase 2 total reactive energy	READ
249	TOT KVARh L3	Phase 3 total reactive energy	READ
250	STATUS	Device status bitBIT0 -> Cyclic phase sense error (1 ERR, 0 OK) BIT1 -> ALARM (1 ACTIVE, 0 NOT ACTIVE)	READ

		BIT2 -> DOUT1 status (1 ACTIVE, 0 NOT ACTIVE) BIT3 -> DOUT2 status (1 ACTIVE, 0 NOT ACTIVE) BIT4 -> DIN1 STATUS (1 high, 0 low) BIT5 -> DIN2 STATUS (1 high, 0 low) BIT6 -> Current Cutoff (1 active, 0 inactive) BIT 7 -> Current error L1 (1 CT connected reverse, 0 CT connected OK) BIT 8 -> Current error L2 (1 CT connected reverse, 0 CT connected OK) BIT 9 -> Current error L3 (1 CT connected inverted, 0 CT connected OK) BIT 10 -> Line 1 Voltage/Current connection error (1 Error, 0 OK) BIT 11 -> Connection error Line 2 Voltage/Current (1 Error, 0 OK) BIT 12 -> Connection error Line 3 Voltage/Current (1 Error, 0 OK)	
251	Wh1	Phase 1 total active energy	READ
252	Wh2	Phase 2 total active energy	READ
253	Wh3	Phase 3 total active energy	READ

PUBLISH BULK FORMAT

Selects the format for "bulk mode" according to the following table:

%c	Device Client ID
%m	Device MAC Address
%M	Device MAC Address without dots
%d	date-time
%t	timestamp (number of seconds from 01/01/1970)
%u	timestamp (number of milliseconds from 01/01/1970)
%b	bulk (format specified in "Publish Bulk Format")
%f	Inserts an ID instead of the variable name (see table)
%n	Tag name (only for "Publish Bulk Format")
%v	Tag value (only in "Publish Bulk Format")
%j[field]	Adds double quotes " to [field]. The double quotes represent a string in JSON

Note: the %f placeholder adds a unique ID to the variable to be published according to the following table:

%f (ID)	VARIABLE	EXPLANATION	TIPO
1	V1N	Voltage between Phase 1 and neutral	READ
2	V1N_AVG	Phase 1 to Neutral Voltage (in demand time)	READ
3	V1N_MIN	Minimum voltage between Phase 1 and neutral (from switch-on)	READ
4	V1N_MAX	Maximum voltage between Phase 1 and neutral (from switch-on)	READ
5	V1N_AVG_MIN	Phase 1 to minimum neutral voltage (in demand time)	READ

6	V1N_AVG_MAX	Phase 1 to maximum neutral voltage (in demand time)	READ
7	V2N	Voltage between Phase 2 and neutral	READ
8	V2N_AVG	Phase 2 to Neutral Voltage (in demand time)	READ
9	V2N_MIN	Minimum voltage between Phase 2 and neutral (from switch-on)	READ
10	V2N_MAX	Maximum voltage between Phase 2 and neutral (from switch-on)	READ
11	V2N_AVG_MIN	Phase 2 to minimum neutral voltage (in demand time)	READ
12	V2N_AVG_MAX	Phase 2 to maximum neutral voltage (in demand time)	READ
13	V3N	Voltage between Phase 3 and neutral	READ
14	V3N_AVG	Phase 3 to Neutral Voltage (in demand time)	READ
15	V3N_MIN	Minimum voltage between Phase 3 and neutral (from switch-on)	READ
16	V3N_MAX	Maximum voltage between Phase 3 and neutral (from switch-on)	READ
17	V3N_AVG_MIN	Phase 3 to minimum neutral voltage (in demand time)	READ
18	V3N_AVG_MAX	Phase 3 to maximum neutral voltage (in demand time)	READ
19	AN	Neutral Current	READ
20	AN_AVG	Neutral Current (on demand time)	READ
21	AN_MIN	Minimum neutral current (from switch-on)	READ
22	AN_MAX	Maximum neutral current (from switch-on)	READ
23	AN_AVG_MIN	Minimum neutral current (in demand time)	READ
24	AN_AVG_MAX	Maximum neutral current (in demand time)	READ
25	V12	Phase-to-phase voltage between Phase 1 and 2	READ
26	V12_AVG	Phase-to-phase voltage between Phase 1 and 2 (in demand time)	READ
27	V12_MIN	Minimum phase-to-phase voltage between Phase 1 and 2 (from switch-on)	READ
28	V12_MAX	Maximum phase-to-phase voltage between Phase 1 and 2 (from switch-on)	READ
29	V12_AVG_MIN	Phase-to-phase voltage between minimum Phase 1 and 2 (in demand time)	READ
30	V12_AVG_MAX	Phase-to-phase voltage between maximum Phase 1 and 2 (in demand time)	READ
31	V23	Phase-to-phase voltage between Phase 2 and 3	READ
32	V23_AVG	Phase-to-phase voltage between Phase 2 and 3 (in demand time)	READ
33	V23_MIN	Minimum phase-to-phase voltage between Phase 2 and 3 (from switch-on)	READ
34	V23_MAX	Maximum phase-to-phase voltage between Phase 2 and 3 (from switch-on)	READ
35	V23_AVG_MIN	Phase-to-phase voltage between minimum Phase 2 and 3 (in demand time)	READ
36	V23_AVG_MAX	Phase-to-phase voltage between maximum Phase 2 and 3 (in demand time)	READ
37	V31	Phase-to-phase voltage between Phase 3 and 1	READ

38	V31_AVG	Phase-to-phase voltage between Phase 3 and 1 (in demand time)	READ
39	V31_MIN	Minimum phase-to-phase voltage between Phase 3 and 1 (from switch-on)	READ
40	V31_MAX	Maximum phase-to-phase voltage between Phase 3 and 1 (from switch-on)	READ
41	V31_AVG_MIN	Phase-to-phase voltage between minimum Phase 3 and 1 (in demand time)	READ
42	V31_AVG_MAX	Phase-to-phase voltage between maximum Phase 3 and 1 (in demand time)	READ
43	Vsys	System voltage:	READ
44	Vsys_AVG	System voltage (in demand time)	READ
45	Vsys_MIN	Minimum system voltage (from switch-on)	READ
46	Vsys_MAX	Maximum system voltage (from switch-on)	READ
47	Vsys_AVG_MIN	Minimum system voltage (in demand time)	READ
48	Vsys_AVG_MAX	Maximum system voltage (in demand time)	READ
49	A1	Phase 1 current	READ
50	A1_AVG	Phase 1 current (in demand time)	READ
51	A1_MIN	Minimum Phase 1 current (from switch-on)	READ
52	A1_MAX	Maximum Phase 1 current (from switch-on)	READ
53	A1_AVG_MIN	Minimum Phase 1 current (in demand time)	READ
54	A1_AVG_MAX	Maximum Phase 1 current (in demand time)	READ
55	A2	Phase 2 current	READ
56	A2_AVG	Phase 2 current (in demand time)	READ
57	A2_MIN	Minimum Phase 2 current (from switch-on)	READ
58	A2_MAX	Maximum Phase 2 current (from switch-on)	READ
59	A2_AVG_MIN	Minimum Phase 2 current (in demand time)	READ
60	A2_AVG_MAX	Maximum Phase 2 current (in demand time)	READ
61	A3	Phase 3 current	READ
62	A3_AVG	Phase 3 current (in demand time)	READ
63	A3_MIN	Minimum Phase 3 current (from switch-on)	READ
64	A3_MAX	Maximum Phase 3 current (from switch-on)	READ
65	A3_AVG_MIN	Minimum Phase 3 current (in demand time)	READ
66	A3_AVG_MAX	Maximum Phase 3 current (in demand time)	READ
67	Asys	System current	READ
68	Asys_AVG	System current (in demand time)	READ
69	Asys_MIN	Minimum system current (from switch-on)	READ
70	Asys_MAX	Maximum system current (from switch-on)	READ
71	Asys_AVG_MIN	Minimum system current (in demand time)	READ
72	Asys_AVG_MAX	Maximum system current (in demand time)	READ
73	P1	Phase 1 Active power	READ
74	P1_AVG	Phase 1 active power (in demand time)	READ
75	P1_MIN	Minimum Phase 1 active power (from switch-on)	READ
76	P1_MAX	Maximum Phase 1 active power (from switch-on)	READ

77	P1_AVG_MIN	Minimum Phase 1 active power (in demand time)	READ
78	P1_AVG_MAX	Maximum Phase 1 active power (in demand time)	READ
79	P2	Phase 2 Active power	READ
80	P2_AVG	Phase 2 active power (in demand time)	READ
81	P2_MIN	Minimum Phase 2 active power (from switch-on)	READ
82	P2_MAX	Maximum Phase 2 active power (from switch-on)	READ
83	P2_AVG_MIN	Minimum Phase 2 active power (in demand time)	READ
84	P2_AVG_MAX	Maximum Phase 2 active power (in demand time)	READ
85	P3	Phase 3 Active power	READ
86	P3_AVG	Phase 3 active power (in demand time)	READ
87	P3_MIN	Minimum Phase 3 active power (from switch-on)	READ
88	P3_MAX	Maximum Phase 3 active power (from switch-on)	READ
89	P3_AVG_MIN	Minimum Phase 3 active power (in demand time)	READ
90	P3_AVG_MAX	Maximum Phase 3 active power (in demand time)	READ
91	Psys	System Active power	READ
92	Psys_AVG	System active power (in demand time)	READ
93	Psys_MIN	Minimum system active power (from switch-on)	READ
94	Psys_MAX	Maximum system active power (from switch-on)	READ
95	Psys_AVG_MIN	Minimum system active power (in demand time)	READ
96	Psys_AVG_MAX	Maximum system active power (in demand time)	READ
97	S1	Phase 1 apparent power	READ
98	S1_AVG	Phase 1 apparent power (in demand time)	READ
99	S1_MIN	Minimum Phase 1 apparent power (from switch-on)	READ
100	S1_MAX	Maximum Phase 1 apparent power (from switch-on)	READ
101	S1_AVG_MIN	Minimum Phase 1 apparent power (in demand time)	READ
102	S1_AVG_MAX	Maximum Phase 1 apparent power (in demand time)	READ
103	S2	Phase 2 apparent power	READ
104	S2_AVG	Phase 2 apparent power (in demand time)	READ
105	S2_MIN	Minimum Phase 2 apparent power (from switch-on)	READ
106	S2_MAX	Maximum Phase 2 apparent power (from switch-on)	READ
107	S2_AVG_MIN	Minimum Phase 2 apparent power (in demand time)	READ
108	S2_AVG_MAX	Maximum Phase 2 apparent power (in demand time)	READ
109	S3	Phase 3 apparent power	READ
110	S3_AVG	Phase 3 apparent power (in demand time)	READ
111	S3_MIN	Minimum Phase 3 apparent power (from switch-on)	READ
112	S3_MAX	Maximum Phase 3 apparent power (from switch-on)	READ
113	S3_AVG_MIN	Minimum Phase 3 apparent power (in demand time)	READ
114	S3_AVG_MAX	Maximum Phase 3 apparent power (in demand time)	READ
115	Ssys	System apparent power	READ
116	Ssys_AVG	System apparent power (in demand time)	READ
117	Ssys_MIN	Minimum system apparent power (from switch-on)	READ
118	Ssys_MAX	Maximum system apparent power (from switch-on)	READ
119	Ssys_AVG_MIN	Minimum system apparent power (in demand time)	READ

120	Ssys_AVG_MAX	Maximum system apparent power (in demand time)	READ
121	Q1	Phase 1 Reactive power	READ
122	Q1_AVG	Phase 1 reactive power (in demand time)	READ
123	Q1_MIN	Minimum Phase 1 reactive power (from switch-on)	READ
124	Q1_MAX	Maximum Phase 1 reactive power (from switch-on)	READ
125	Q1_AVG_MIN	Minimum Phase 1 reactive power (in demand time)	READ
126	Q1_AVG_MAX	Maximum Phase 1 reactive power (in demand time)	READ
127	Q2	Phase 2 Reactive power	READ
128	Q2_AVG	Phase 2 reactive power (in demand time)	READ
129	Q2_MIN	Minimum Phase 2 reactive power (from switch-on)	READ
130	Q2_MAX	Maximum Phase 2 reactive power (from switch-on)	READ
131	Q2_AVG_MIN	Minimum Phase 2 reactive power (in demand time)	READ
132	Q2_AVG_MAX	Maximum Phase 2 reactive power (in demand time)	READ
133	Q3	Phase 3 Reactive power	READ
134	Q3_AVG	Phase 3 reactive power (in demand time)	READ
135	Q3_MIN	Minimum Phase 3 reactive power (from switch-on)	READ
136	Q3_MAX	Maximum Phase 3 reactive power (from switch-on)	READ
137	Q3_AVG_MIN	Minimum Phase 3 reactive power (in demand time)	READ
138	Q3_AVG_MAX	Maximum Phase 3 reactive power (in demand time)	READ
139	Qsys	System Reactive power	READ
140	Qsys_AVG	System reactive power (in demand time)	READ
141	Qsys_MIN	Minimum system reactive power (from switch-on)	READ
142	Qsys_MAX	Maximum system reactive power (from switch-on)	READ
143	Qsys_AVG_MIN	Minimum system reactive power (in demand time)	READ
144	Qsys_AVG_MAX	Maximum system reactive power (in demand time)	READ
145	TPF1	Phase 1 Power factor	READ
146	TPF1_AVG	Phase 1 power factor (in demand time)	READ
147	TPF1_MIN	Minimum Phase 1 power factor (from switch-on)	READ
148	TPF1_MAX	Maximum Phase 1 power factor (from switch-on)	READ
149	TPF1_AVG_MIN	Minimum Phase 1 power factor (in demand time)	READ
150	TPF1_AVG_MAX	Maximum Phase 1 power factor (in demand time)	READ
151	TPF2	Phase 2 Power factor	READ
152	TPF2_AVG	Phase 2 power factor (in demand time)	READ
153	TPF2_MIN	Minimum Phase 2 power factor (from switch-on)	READ
154	TPF2_MAX	Maximum Phase 2 power factor (from switch-on)	READ
155	TPF2_AVG_MIN	Minimum Phase 2 power factor (in demand time)	READ
156	TPF2_AVG_MAX	Maximum Phase 2 power factor (in demand time)	READ
157	TPF3	Phase 3 Power factor	READ
158	TPF3_AVG	Phase 3 power factor (in demand time)	READ
159	TPF3_MIN	Minimum Phase 3 power factor (from switch-on)	READ
160	TPF3_MAX	Maximum Phase 3 power factor (from switch-on)	READ
161	TPF3_AVG_MIN	Minimum Phase 3 power factor (in demand time)	READ
162	TPF3_AVG_MAX	Maximum Phase 3 power factor (in demand time)	READ

163	TPFsys	System Power factor	READ
164	TPFsys_AVG	System power factor (in demand time)	READ
165	TPFsys_MIN	Minimum system power factor (from switch-on)	READ
166	TPFsys_MAX	Minimum system power factor (from switch-on)	READ
167	TPFsys_AVG_MIN	Minimum system power factor (in demand time)	READ
168	TPFsys_AVG_MAX	Maximum system power factor (in demand time)	READ
169	THD-V1N	Voltage THD (Total Harmonic Distortion) between Phase 1 and neutral	READ
170	THD-V1N_AVG	Voltage THD between Phase 1 and neutral (in demand time)	READ
171	THD-V1N_MIN	Minimum voltage THD between Phase 1 and neutral (from switch-on)	READ
172	THD-V1N_MAX	Maximum voltage THD between Phase 1 and neutral (from switch-on)	READ
173	THD-V1N_AVG_MIN	Minimum voltage THD between Phase 1 and neutral (in demand time)	READ
174	THD-V1N_AVG_MAX	Maximum voltage THD between Phase 1 and neutral (in demand time)	READ
175	THD-V2N	Voltage THD between Phase 2 and neutral	READ
176	THD-V2N_AVG	Voltage THD between Phase 2 and neutral (in demand time)	READ
177	THD-V2N_MIN	Minimum voltage THD between Phase 2 and neutral (from switch-on)	READ
178	THD-V2N_MAX	Maximum voltage THD between Phase 2 and neutral (from switch-on)	READ
179	THD-V2N_AVG_MIN	Minimum voltage THD between Phase 2 and neutral (in demand time)	READ
180	THD-V2N_AVG_MAX	Maximum voltage THD between Phase 2 and neutral (in demand time)	READ
181	THD-V3N	Voltage THD between Phase 3 and neutral	READ
182	THD-V3N_AVG	Voltage THD between Phase 3 and neutral (in demand time)	READ
183	THD-V3N_MIN	Minimum voltage THD between Phase 3 and neutral (from switch-on)	READ
184	THD-V3N_MAX	Maximum voltage THD between Phase 3 and neutral (from switch-on)	READ
185	THD-V3N_AVG_MIN	Minimum voltage THD between Phase 3 and neutral (in demand time)	READ
186	THD-V3N_AVG_MAX	Maximum voltage THD between Phase 3 and neutral (in demand time)	READ
187	f	Phase frequency (read from Phase 1)	READ
188	THD-A1N	Phase 1 current THD	READ
189	THD-A1N_AVG	Phase 1 current THD (in demand time)	READ
190	THD-A1N_MIN	Minimum Phase 1 current THD (from switch-on)	READ
191	THD-A1N_MAX	Maximum Phase 1 current THD (from switch-on)	READ
192	THD-A1N_AVG_MIN	Minimum Phase 1 current THD (in demand time)	READ
193	THD-A1N_AVG_MAX	Maximum Phase 1 current THD (in demand time)	READ
194	THD-A2N	Phase 2 current THD	READ

195	THD-A2N_AVG	Phase 2 current THD (in demand time)	READ
196	THD-A2N_MIN	Minimum Phase 2 current THD (from switch-on)	READ
197	THD-A2N_MAX	Maximum Phase 2 current THD (from switch-on)	READ
198	THD-A2N_AVG_MIN	Minimum Phase 2 current THD (in demand time)	READ
199	THD-A2N_AVG_MAX	Maximum Phase 2 current THD (in demand time)	READ
200	THD-A3N	Phase 3 current THD	READ
201	THD-A3N_AVG	Phase 3 current THD (in demand time)	READ
202	THD-A3N_MIN	Minimum Phase 3 current THD (from switch-on)	READ
203	THD-A3N_MAX	Maximum Phase 3 current THD (from switch-on)	READ
204	THD-A3N_AVG_MIN	Minimum Phase 3 current THD (in demand time)	READ
205	THD-A3N_AVG_MAX	Maximum Phase 3 current THD (in demand time)	READ
206	+WH1	Phase 1 positive active energy	READ
207	+WH2	Phase 2 positive active energy	READ
208	+WH3	Phase 3 positive active energy	READ
209	+Wh	Total positive active energy	READ
210	-WH1	Phase 1 negative active energy	READ
211	-WH2	Phase 2 negative active energy	READ
212	-WH3	Phase 3 negative active energy	READ
213	-Wh	Total negative active energy	READ
214	VAh1	Phase 1 apparent energy	READ
215	VAh2	Phase 2 apparent energy	READ
216	VAh3	Phase 3 apparent energy	READ
217	VAh	Total apparent energy	READ
218	+VARh1-L[Q1]	Phase 1 positive inductive reactive energy (Q1)	READ
219	+VARh2-L[Q1]	Phase 2 positive inductive reactive energy (Q1)	READ
220	+VARh3-L[Q1]	Phase 3 positive inductive reactive energy (Q1)	READ
221	+VARh-L[Q1]	Total positive inductive reactive energy (Q1)	READ
222	-VARh1-C[Q4]	Phase 1 negative capacitive reactive energy (Q4)	READ
223	-VARh2-C[Q4]	Phase 2 negative capacitive reactive energy (Q4)	READ
224	-VARh3-C[Q4]	Phase 3 negative capacitive reactive energy (Q4)	READ
225	-VARh-C[Q4]	Total negative capacitive reactive energy (Q4)	READ
226	-VARh1-L[Q3]	Phase 1 negative inductive reactive energy (Q3)	READ
227	-VARh2-L[Q3]	Phase 2 negative inductive reactive energy (Q3)	READ
228	-VARh3-L[Q3]	Phase 3 negative inductive reactive energy (Q3)	READ
229	-VARh-L[Q3]	Total negative inductive reactive energy (Q3)	READ
230	+VARh1-C[Q2]	Phase 1 positive capacitive reactive energy (Q2)	READ
231	+VARh2-C[Q2]	Phase 2 positive capacitive reactive energy (Q2)	READ
232	+VARh3-C[Q2]	Phase 3 positive capacitive reactive energy (Q2)	READ
233	+VARh-C[Q2]	Total positive capacitive reactive energy (Q2)	READ
234	Wh	Total active energy	READ

235	VARh	Total reactive energy	READ
236	VARh-L[Q1Q3]	Total inductive reactive energy (Q1+Q3)	READ
237	VARh-C[Q2Q4]	Total capacitive reactive energy (Q2+Q4)	READ
238	VAh	Total apparent energy	READ
239	COUNTER 1	Input 1 pulse counter	READ
240	COUNTER 2	Input 2 pulse counter	READ
241	DIGITAL_IN_1	Digital Input 1	READ
242	DIGITAL_IN_2	Digital Input 2	READ
243	DIGITAL_OUT_1	Digital output 1	READ/ WRITE
244	DIGITAL_OUT_2	Digital output 2	READ/ WRITE
245	ANALOG OUT	Value to load on analog output (R203 models only) in uA or mV	READ/ WRITE
246	COMMAND	Command register. Supported commands: 260 decimal to reset MIN/MAX 259 decimal to reset AVG demand time values 261 decimal to reset Energy Counters	READ/ WRITE
247	TOT KVARh L1	Phase 1 total reactive energy	READ
248	TOT KVARh L2	Phase 2 total reactive energy	READ
249	TOT KVARh L3	Phase 3 total reactive energy	READ
250	STATUS	Device status bit BIT0 -> Cyclic phase sense error (1 ERR, 0 OK) BIT1 -> ALARM (1 ACTIVE, 0 NOT ACTIVE) BIT2 -> DOUT1 status (1 ACTIVE, 0 NOT ACTIVE) BIT3 -> DOUT2 status (1 ACTIVE, 0 NOT ACTIVE) BIT4 -> DIN1 STATUS (1 high, 0 low) BIT5 -> DIN2 STATUS (1 high, 0 low) BIT6 -> Current Cutoff (1 active, 0 inactive) BIT 7 -> Current error L1 (1 CT connected reverse, 0 CT connected OK) BIT 8 -> Current error L2 (1 CT connected reverse, 0 CT connected OK) BIT 9 -> Current error L3 (1 CT connected inverted, 0 CT connected OK) BIT 10 -> Line 1 Voltage/Current connection error (1 Error, 0 OK) BIT 11 -> Connection error Line 2 Voltage/Current (1 Error, 0 OK) BIT 12 -> Connection error Line 3 Voltage/Current (1 Error, 0 OK)	READ
251	Wh1	Phase 1 total active energy	READ
252	Wh2	Phase 2 total active energy	READ
253	Wh3	Phase 3 total active energy	READ

PUBLISH TOPIC FOR EVENT

indicates the MQTT topic on which the device will send events from the event datalogger *using the following table:*

%c	Device Client ID
%m	Device MAC Address

%M	Device MAC Address without dot separator
%j[field]	Adds double quotes " to [field]. The double quotes represent a string in JSON

PUBLISH PAYLOAD FOR EVENT

Selects the format to be used for the payload using the following table:

%c	Device Client ID
%m	Device MAC Address
%M	Device MAC Address without dots
%d	date-time
%t	timestamp (number of seconds from 01/01/1970)
%u	timestamp (number of milliseconds from 01/01/1970)
%x	Text of the event
%j[field]	Adds double quotes " to [field]. The double quotes represent a string in JSON

SUBSCRIBE TOPIC FOR COMMANDS

indicates the MQTT topic on which to send commands to the device *using the following table*:

%c	Device Client ID
%m	Device MAC Address
%M	Device MAC Address without dot separator
%j[field]	Adds double quotes " to [field]. The double quotes represent a string in JSON

The uploaded certificates must have the following names and extensions:

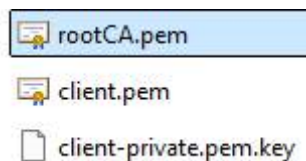

ROOT CA CERTIFICATE FILE (.crt)

File representing the Root CA Certificate (public key + CA signature) of the broker in .crt format

SERVER CERTIFICATE FILE (.crt)

File representing the Client Certificate in .crt format, it is generated by the broker passing the client's public key

CLIENT PRIVATE KEY FILE (.key)

File that represents the private Client key in .key format.

16.9.1. *EXAMPLES*

With the following configuration:

CLIENT ID = R203 MQTT Client

PUBLISH TOPIC FOR LOGS = seneca/%c/data

PUBLISH PAYLOAD FOR LOGS = {"t":%jt,"v":[%b]}

PUBLISH BULK FORMAT = {"n":%jn,"v":%jv}

You will get in the topic

seneca/R203 MQTT Client/data

the following content:

```
{
  "t": "1687536452",
  "v": [
    { "n": "V1N", "v": "0.088" },
    { "n": "V1N_AVG", "v": "0.006" },
    { "n": "V1N_MIN", "v": "0.079" },
    { "n": "V1N_MAX", "v": "0.096" },
    { "n": "V1N_AVG_MIN", "v": "0.001" },
    { "n": "V1N_AVG_MAX", "v": "0.089" },
    { "n": "V2N", "v": "0.087" },
    { "n": "V31_MIN", "v": "0.000" },
    { "n": "V2N_AVG_MIN", "v": "0.002" },
    { "n": "V2N_AVG_MAX", "v": "0.090" },
    { "n": "V3N", "v": "0.081" },
    { "n": "V23_AVG_MAX", "v": "0.016" },
    { "n": "V3N_MIN", "v": "0.074" },
    { "n": "V3N_MAX", "v": "0.090" },
    { "n": "V31_AVG_MAX", "v": "0.016" },
    { "n": "Vsys", "v": "0.316" },
    { "n": "Vsys_AVG", "v": "0.016" },
    { "n": "Vsys_MIN", "v": "0.000" },
    { "n": "Vsys_MAX", "v": "0.316" },
    { "n": "Vsys_AVG_MIN", "v": "0.000" }
  ]
}
```

16.9.2. *DIREL ADM4.0*

The parameters for the Direl cloud (<https://www.direl.it/>) are as follows:

Field	Meaning
Enable	Enables or disables the connection to the Direl ADM4.0 cloud
Username for Commands	This is the username for writing access from the cloud to the device
Password for Commands	It is the password for writing access from the cloud to the device

16.9.3. *SENECA CLOUDBOX 2*

Seneca Cloudbox2 is the Seneca cloud, for more information refer to the site:

<https://www.seneca.it>



The parameters for the connection are:

Field	Meaning
Username	This is the username for accessing the cloud
Password	This is the password for accessing the cloud

16.10. SYSTEM CONNECTION SECTION -> HTTP

MAX FAILURE COUNTER

It is the maximum number of attempts without a pause before declaring a transmission fail.

WAIT AFTER FAILURE (minutes)

It is the pause in minutes before trying to connect again

SSL/TLS

Defines whether to enable the SSL/TLS 1.2 encrypted security protocol

HOST

This is the host of the HTTP server

PORT

This is the HTTP server port

AUTHENTICATION

Activates or not the authentication with username and password

USERNAME

Authentication Username

PASSWORD

Authentication Password

LOG ON CHANGE

Sends data on change

HYSTERESIS

Hysteresis for sending data on change

PUBLISH WITH MULTIPLE TAGS

This parameter defines whether the post contains multiple tags or whether the device should send a post for each tag.

PUBLISH PAYLOAD FOR LOGS

Selects the format to be used for the payload of the data datalogger using the following table:

%c	Device Client ID
%m	Device MAC Address
%M	Device MAC Address without dots
%d	date-time
%t	timestamp (number of seconds from 01/01/1970)
%u	timestamp (number of milliseconds from 01/01/1970)
%b	bulk (format specified in "Publish Bulk Format")
%f	Inserts an ID instead of the variable name (see table)
%n	Tag name (only for "Publish Bulk Format")
%v	Tag value (only in "Publish Bulk Format")
%j[field]	Adds double quotes " to [field]. The double quotes represent a string in JSON

Note: the %f placeholder adds a unique ID to the variable to be published according to the following table:

%f (ID)	VARIABLE	EXPLANATION	TIPO
1	V1N	Voltage between Phase 1 and neutral	READ
2	V1N_AVG	Phase 1 to Neutral Voltage (in demand time)	READ
3	V1N_MIN	Minimum voltage between Phase 1 and neutral (from switch-on)	READ
4	V1N_MAX	Maximum voltage between Phase 1 and neutral (from switch-on)	READ
5	V1N_AVG_MIN	Phase 1 to minimum neutral voltage (in demand time)	READ
6	V1N_AVG_MAX	Phase 1 to maximum neutral voltage (in demand time)	READ
7	V2N	Voltage between Phase 2 and neutral	READ
8	V2N_AVG	Phase 2 to Neutral Voltage (in demand time)	READ
9	V2N_MIN	Minimum voltage between Phase 2 and neutral (from switch-on)	READ
10	V2N_MAX	Maximum voltage between Phase 2 and neutral (from switch-on)	READ
11	V2N_AVG_MIN	Phase 2 to minimum neutral voltage (in demand time)	READ
12	V2N_AVG_MAX	Phase 2 to maximum neutral voltage (in demand time)	READ
13	V3N	Voltage between Phase 3 and neutral	READ
14	V3N_AVG	Phase 3 to Neutral Voltage (in demand time)	READ
15	V3N_MIN	Minimum voltage between Phase 3 and neutral (from switch-on)	READ
16	V3N_MAX	Maximum voltage between Phase 3 and neutral (from switch-on)	READ
17	V3N_AVG_MIN	Phase 3 to minimum neutral voltage (in demand time)	READ
18	V3N_AVG_MAX	Phase 3 to maximum neutral voltage (in demand time)	READ
19	AN	Neutral Current	READ
20	AN_AVG	Neutral Current (on demand time)	READ
21	AN_MIN	Minimum neutral current (from switch-on)	READ
22	AN_MAX	Maximum neutral current (from switch-on)	READ
23	AN_AVG_MIN	Minimum neutral current (in demand time)	READ
24	AN_AVG_MAX	Maximum neutral current (in demand time)	READ
25	V12	Phase-to-phase voltage between Phase 1 and 2	READ

26	V12_AVG	Phase-to-phase voltage between Phase 1 and 2 (in demand time)	READ
27	V12_MIN	Minimum phase-to-phase voltage between Phase 1 and 2 (from switch-on)	READ
28	V12_MAX	Maximum phase-to-phase voltage between Phase 1 and 2 (from switch-on)	READ
29	V12_AVG_MIN	Phase-to-phase voltage between minimum Phase 1 and 2 (in demand time)	READ
30	V12_AVG_MAX	Phase-to-phase voltage between maximum Phase 1 and 2 (in demand time)	READ
31	V23	Phase-to-phase voltage between Phase 2 and 3	READ
32	V23_AVG	Phase-to-phase voltage between Phase 2 and 3 (in demand time)	READ
33	V23_MIN	Minimum phase-to-phase voltage between Phase 2 and 3 (from switch-on)	READ
34	V23_MAX	Maximum phase-to-phase voltage between Phase 2 and 3 (from switch-on)	READ
35	V23_AVG_MIN	Phase-to-phase voltage between minimum Phase 2 and 3 (in demand time)	READ
36	V23_AVG_MAX	Phase-to-phase voltage between maximum Phase 2 and 3 (in demand time)	READ
37	V31	Phase-to-phase voltage between Phase 3 and 1	READ
38	V31_AVG	Phase-to-phase voltage between Phase 3 and 1 (in demand time)	READ
39	V31_MIN	Minimum phase-to-phase voltage between Phase 3 and 1 (from switch-on)	READ
40	V31_MAX	Maximum phase-to-phase voltage between Phase 3 and 1 (from switch-on)	READ
41	V31_AVG_MIN	Phase-to-phase voltage between minimum Phase 3 and 1 (in demand time)	READ
42	V31_AVG_MAX	Phase-to-phase voltage between maximum Phase 3 and 1 (in demand time)	READ
43	Vsys	System voltage:	READ
44	Vsys_AVG	System voltage (in demand time)	READ
45	Vsys_MIN	Minimum system voltage (from switch-on)	READ
46	Vsys_MAX	Maximum system voltage (from switch-on)	READ
47	Vsys_AVG_MIN	Minimum system voltage (in demand time)	READ
48	Vsys_AVG_MAX	Maximum system voltage (in demand time)	READ
49	A1	Phase 1 current	READ
50	A1_AVG	Phase 1 current (in demand time)	READ
51	A1_MIN	Minimum Phase 1 current (from switch-on)	READ
52	A1_MAX	Maximum Phase 1 current (from switch-on)	READ
53	A1_AVG_MIN	Minimum Phase 1 current (in demand time)	READ
54	A1_AVG_MAX	Maximum Phase 1 current (in demand time)	READ
55	A2	Phase 2 current	READ
56	A2_AVG	Phase 2 current (in demand time)	READ
57	A2_MIN	Minimum Phase 2 current (from switch-on)	READ
58	A2_MAX	Maximum Phase 2 current (from switch-on)	READ
59	A2_AVG_MIN	Minimum Phase 2 current (in demand time)	READ

60	A2_AVG_MAX	Maximum Phase 2 current (in demand time)	READ
61	A3	Phase 3 current	READ
62	A3_AVG	Phase 3 current (in demand time)	READ
63	A3_MIN	Minimum Phase 3 current (from switch-on)	READ
64	A3_MAX	Maximum Phase 3 current (from switch-on)	READ
65	A3_AVG_MIN	Minimum Phase 3 current (in demand time)	READ
66	A3_AVG_MAX	Maximum Phase 3 current (in demand time)	READ
67	Asys	System current	READ
68	Asys_AVG	System current (in demand time)	READ
69	Asys_MIN	Minimum system current (from switch-on)	READ
70	Asys_MAX	Maximum system current (from switch-on)	READ
71	Asys_AVG_MIN	Minimum system current (in demand time)	READ
72	Asys_AVG_MAX	Maximum system current (in demand time)	READ
73	P1	Phase 1 Active power	READ
74	P1_AVG	Phase 1 active power (in demand time)	READ
75	P1_MIN	Minimum Phase 1 active power (from switch-on)	READ
76	P1_MAX	Maximum Phase 1 active power (from switch-on)	READ
77	P1_AVG_MIN	Minimum Phase 1 active power (in demand time)	READ
78	P1_AVG_MAX	Maximum Phase 1 active power (in demand time)	READ
79	P2	Phase 2 Active power	READ
80	P2_AVG	Phase 2 active power (in demand time)	READ
81	P2_MIN	Minimum Phase 2 active power (from switch-on)	READ
82	P2_MAX	Maximum Phase 2 active power (from switch-on)	READ
83	P2_AVG_MIN	Minimum Phase 2 active power (in demand time)	READ
84	P2_AVG_MAX	Maximum Phase 2 active power (in demand time)	READ
85	P3	Phase 3 Active power	READ
86	P3_AVG	Phase 3 active power (in demand time)	READ
87	P3_MIN	Minimum Phase 3 active power (from switch-on)	READ
88	P3_MAX	Maximum Phase 3 active power (from switch-on)	READ
89	P3_AVG_MIN	Minimum Phase 3 active power (in demand time)	READ
90	P3_AVG_MAX	Maximum Phase 3 active power (in demand time)	READ
91	Psys	System Active power	READ
92	Psys_AVG	System active power (in demand time)	READ
93	Psys_MIN	Minimum system active power (from switch-on)	READ
94	Psys_MAX	Maximum system active power (from switch-on)	READ
95	Psys_AVG_MIN	Minimum system active power (in demand time)	READ
96	Psys_AVG_MAX	Maximum system active power (in demand time)	READ
97	S1	Phase 1 apparent power	READ
98	S1_AVG	Phase 1 apparent power (in demand time)	READ
99	S1_MIN	Minimum Phase 1 apparent power (from switch-on)	READ
100	S1_MAX	Maximum Phase 1 apparent power (from switch-on)	READ
101	S1_AVG_MIN	Minimum Phase 1 apparent power (in demand time)	READ
102	S1_AVG_MAX	Maximum Phase 1 apparent power (in demand time)	READ

103	S2	Phase 2 apparent power	READ
104	S2_AVG	Phase 2 apparent power (in demand time)	READ
105	S2_MIN	Minimum Phase 2 apparent power (from switch-on)	READ
106	S2_MAX	Maximum Phase 2 apparent power (from switch-on)	READ
107	S2_AVG_MIN	Minimum Phase 2 apparent power (in demand time)	READ
108	S2_AVG_MAX	Maximum Phase 2 apparent power (in demand time)	READ
109	S3	Phase 3 apparent power	READ
110	S3_AVG	Phase 3 apparent power (in demand time)	READ
111	S3_MIN	Minimum Phase 3 apparent power (from switch-on)	READ
112	S3_MAX	Maximum Phase 3 apparent power (from switch-on)	READ
113	S3_AVG_MIN	Minimum Phase 3 apparent power (in demand time)	READ
114	S3_AVG_MAX	Maximum Phase 3 apparent power (in demand time)	READ
115	Ssys	System apparent power	READ
116	Ssys_AVG	System apparent power (in demand time)	READ
117	Ssys_MIN	Minimum system apparent power (from switch-on)	READ
118	Ssys_MAX	Maximum system apparent power (from switch-on)	READ
119	Ssys_AVG_MIN	Minimum system apparent power (in demand time)	READ
120	Ssys_AVG_MAX	Maximum system apparent power (in demand time)	READ
121	Q1	Phase 1 Reactive power	READ
122	Q1_AVG	Phase 1 reactive power (in demand time)	READ
123	Q1_MIN	Minimum Phase 1 reactive power (from switch-on)	READ
124	Q1_MAX	Maximum Phase 1 reactive power (from switch-on)	READ
125	Q1_AVG_MIN	Minimum Phase 1 reactive power (in demand time)	READ
126	Q1_AVG_MAX	Maximum Phase 1 reactive power (in demand time)	READ
127	Q2	Phase 2 Reactive power	READ
128	Q2_AVG	Phase 2 reactive power (in demand time)	READ
129	Q2_MIN	Minimum Phase 2 reactive power (from switch-on)	READ
130	Q2_MAX	Maximum Phase 2 reactive power (from switch-on)	READ
131	Q2_AVG_MIN	Minimum Phase 2 reactive power (in demand time)	READ
132	Q2_AVG_MAX	Maximum Phase 2 reactive power (in demand time)	READ
133	Q3	Phase 3 Reactive power	READ
134	Q3_AVG	Phase 3 reactive power (in demand time)	READ
135	Q3_MIN	Minimum Phase 3 reactive power (from switch-on)	READ
136	Q3_MAX	Maximum Phase 3 reactive power (from switch-on)	READ
137	Q3_AVG_MIN	Minimum Phase 3 reactive power (in demand time)	READ
138	Q3_AVG_MAX	Maximum Phase 3 reactive power (in demand time)	READ
139	Qsys	System Reactive power	READ
140	Qsys_AVG	System reactive power (in demand time)	READ
141	Qsys_MIN	Minimum system reactive power (from switch-on)	READ
142	Qsys_MAX	Maximum system reactive power (from switch-on)	READ
143	Qsys_AVG_MIN	Minimum system reactive power (in demand time)	READ
144	Qsys_AVG_MAX	Maximum system reactive power (in demand time)	READ
145	TPF1	Phase 1 Power factor	READ

146	TPF1_AVG	Phase 1 power factor (in demand time)	READ
147	TPF1_MIN	Minimum Phase 1 power factor (from switch-on)	READ
148	TPF1_MAX	Maximum Phase 1 power factor (from switch-on)	READ
149	TPF1_AVG_MIN	Minimum Phase 1 power factor (in demand time)	READ
150	TPF1_AVG_MAX	Maximum Phase 1 power factor (in demand time)	READ
151	TPF2	Phase 2 Power factor	READ
152	TPF2_AVG	Phase 2 power factor (in demand time)	READ
153	TPF2_MIN	Minimum Phase 2 power factor (from switch-on)	READ
154	TPF2_MAX	Maximum Phase 2 power factor (from switch-on)	READ
155	TPF2_AVG_MIN	Minimum Phase 2 power factor (in demand time)	READ
156	TPF2_AVG_MAX	Maximum Phase 2 power factor (in demand time)	READ
157	TPF3	Phase 3 Power factor	READ
158	TPF3_AVG	Phase 3 power factor (in demand time)	READ
159	TPF3_MIN	Minimum Phase 3 power factor (from switch-on)	READ
160	TPF3_MAX	Maximum Phase 3 power factor (from switch-on)	READ
161	TPF3_AVG_MIN	Minimum Phase 3 power factor (in demand time)	READ
162	TPF3_AVG_MAX	Maximum Phase 3 power factor (in demand time)	READ
163	TPFsys	System Power factor	READ
164	TPFsys_AVG	System power factor (in demand time)	READ
165	TPFsys_MIN	Minimum system power factor (from switch-on)	READ
166	TPFsys_MAX	Minimum system power factor (from switch-on)	READ
167	TPFsys_AVG_MIN	Minimum system power factor (in demand time)	READ
168	TPFsys_AVG_MAX	Maximum system power factor (in demand time)	READ
169	THD-V1N	Voltage THD (Total Harmonic Distortion) between Phase 1 and neutral	READ
170	THD-V1N_AVG	Voltage THD between Phase 1 and neutral (in demand time)	READ
171	THD-V1N_MIN	Minimum voltage THD between Phase 1 and neutral (from switch-on)	READ
172	THD-V1N_MAX	Maximum voltage THD between Phase 1 and neutral (from switch-on)	READ
173	THD-V1N_AVG_MIN	Minimum voltage THD between Phase 1 and neutral (in demand time)	READ
174	THD-V1N_AVG_MAX	Maximum voltage THD between Phase 1 and neutral (in demand time)	READ
175	THD-V2N	Voltage THD between Phase 2 and neutral	READ
176	THD-V2N_AVG	Voltage THD between Phase 2 and neutral (in demand time)	READ
177	THD-V2N_MIN	Minimum voltage THD between Phase 2 and neutral (from switch-on)	READ
178	THD-V2N_MAX	Maximum voltage THD between Phase 2 and neutral (from switch-on)	READ
179	THD-V2N_AVG_MIN	Minimum voltage THD between Phase 2 and neutral (in demand time)	READ
180	THD-V2N_AVG_MAX	Maximum voltage THD between Phase 2 and neutral (in demand time)	READ
181	THD-V3N	Voltage THD between Phase 3 and neutral	READ
182	THD-V3N_AVG	Voltage THD between Phase 3 and neutral (in demand time)	READ
183	THD-V3N_MIN	Minimum voltage THD between Phase 3 and neutral (from switch-on)	READ
184	THD-V3N_MAX	Maximum voltage THD between Phase 3 and neutral (from switch-on)	READ

185	THD-V3N_AVG_MIN	Minimum voltage THD between Phase 3 and neutral (in demand time)	READ
186	THD-V3N_AVG_MAX	Maximum voltage THD between Phase 3 and neutral (in demand time)	READ
187	f	Phase frequency (read from Phase 1)	READ
188	THD-A1N	Phase 1 current THD	READ
189	THD-A1N_AVG	Phase 1 current THD (in demand time)	READ
190	THD-A1N_MIN	Minimum Phase 1 current THD (from switch-on)	READ
191	THD-A1N_MAX	Maximum Phase 1 current THD (from switch-on)	READ
192	THD-A1N_AVG_MIN	Minimum Phase 1 current THD (in demand time)	READ
193	THD-A1N_AVG_MAX	Maximum Phase 1 current THD (in demand time)	READ
194	THD-A2N	Phase 2 current THD	READ
195	THD-A2N_AVG	Phase 2 current THD (in demand time)	READ
196	THD-A2N_MIN	Minimum Phase 2 current THD (from switch-on)	READ
197	THD-A2N_MAX	Maximum Phase 2 current THD (from switch-on)	READ
198	THD-A2N_AVG_MIN	Minimum Phase 2 current THD (in demand time)	READ
199	THD-A2N_AVG_MAX	Maximum Phase 2 current THD (in demand time)	READ
200	THD-A3N	Phase 3 current THD	READ
201	THD-A3N_AVG	Phase 3 current THD (in demand time)	READ
202	THD-A3N_MIN	Minimum Phase 3 current THD (from switch-on)	READ
203	THD-A3N_MAX	Maximum Phase 3 current THD (from switch-on)	READ
204	THD-A3N_AVG_MIN	Minimum Phase 3 current THD (in demand time)	READ
205	THD-A3N_AVG_MAX	Maximum Phase 3 current THD (in demand time)	READ
206	+WH1	Phase 1 positive active energy	READ
207	+WH2	Phase 2 positive active energy	READ
208	+WH3	Phase 3 positive active energy	READ
209	+Wh	Total positive active energy	READ
210	-WH1	Phase 1 negative active energy	READ
211	-WH2	Phase 2 negative active energy	READ
212	-WH3	Phase 3 negative active energy	READ
213	-Wh	Total negative active energy	READ
214	VAh1	Phase 1 apparent energy	READ
215	VAh2	Phase 2 apparent energy	READ
216	VAh3	Phase 3 apparent energy	READ
217	VAh	Total apparent energy	READ
218	+VARh1-L[Q1]	Phase 1 positive inductive reactive energy (Q1)	READ
219	+VARh2-L[Q1]	Phase 2 positive inductive reactive energy (Q1)	READ
220	+VARh3-L[Q1]	Phase 3 positive inductive reactive energy (Q1)	READ
221	+VARh-L[Q1]	Total positive inductive reactive energy (Q1)	READ

222	-VARh1-C[Q4]	Phase 1 negative capacitive reactive energy (Q4)	READ
223	-VARh2-C[Q4]	Phase 2 negative capacitive reactive energy (Q4)	READ
224	-VARh3-C[Q4]	Phase 3 negative capacitive reactive energy (Q4)	READ
225	-VARh-C[Q4]	Total negative capacitive reactive energy (Q4)	READ
226	-VARh1-L[Q3]	Phase 1 negative inductive reactive energy (Q3)	READ
227	-VARh2-L[Q3]	Phase 2 negative inductive reactive energy (Q3)	READ
228	-VARh3-L[Q3]	Phase 3 negative inductive reactive energy (Q3)	READ
229	-VARh-L[Q3]	Total negative inductive reactive energy (Q3)	READ
230	+VARh1-C[Q2]	Phase 1 positive capacitive reactive energy (Q2)	READ
231	+VARh2-C[Q2]	Phase 2 positive capacitive reactive energy (Q2)	READ
232	+VARh3-C[Q2]	Phase 3 positive capacitive reactive energy (Q2)	READ
233	+VARh-C[Q2]	Total positive capacitive reactive energy (Q2)	READ
234	Wh	Total active energy	READ
235	VARh	Total reactive energy	READ
236	VARh-L[Q1Q3]	Total inductive reactive energy (Q1+Q3)	READ
237	VARh-C[Q2Q4]	Total capacitive reactive energy (Q2+Q4)	READ
238	VAh	Total apparent energy	READ
239	COUNTER 1	Input 1 pulse counter	READ
240	COUNTER 2	Input 2 pulse counter	READ
241	DIGITAL_IN_1	Digital Input 1	READ
242	DIGITAL_IN_2	Digital Input 2	READ
243	DIGITAL_OUT_1	Digital output 1	READ/ WRITE
244	DIGITAL_OUT_2	Digital output 2	READ/ WRITE
245	ANALOG OUT	Value to load on analog output (R203 models only) in uA or mV	READ/ WRITE
246	COMMAND	Command register. Supported commands: 260 decimal to reset MIN/MAX 259 decimal to reset AVG demand time values 261 decimal to reset Energy Counters	READ/ WRITE
247	TOT KVARh L1	Phase 1 total reactive energy	READ
248	TOT KVARh L2	Phase 2 total reactive energy	READ
249	TOT KVARh L3	Phase 3 total reactive energy	READ
250	STATUS	Device status bit BIT0 -> Cyclic phase sense error (1 ERR, 0 OK) BIT1 -> ALARM (1 ACTIVE, 0 NOT ACTIVE) BIT2 -> DOUT1 status (1 ACTIVE, 0 NOT ACTIVE) BIT3 -> DOUT2 status (1 ACTIVE, 0 NOT ACTIVE) BIT4 -> DIN1 STATUS (1 high, 0 low) BIT5 -> DIN2 STATUS (1 high, 0 low) BIT6 -> Current Cutoff (1 active, 0 inactive) BIT 7 -> Current error L1 (1 CT connected reverse, 0 CT connected OK) BIT 8 -> Current error L2 (1 CT connected reverse, 0 CT connected OK) BIT 9 -> Current error L3 (1 CT connected inverted, 0 CT connected OK) BIT 10 -> Line 1 Voltage/Current connection error (1 Error, 0 OK) BIT 11 -> Connection error Line 2 Voltage/Current (1 Error, 0 OK) BIT 12 -> Connection error Line 3 Voltage/Current (1 Error, 0 OK)	READ

251	Wh1	Phase 1 total active energy	READ
252	Wh2	Phase 2 total active energy	READ
253	Wh3	Phase 3 total active energy	READ

PUBLISH BULK FORMAT

Selects the format for "bulk mode" according to the following table:

%c	Device Client ID
%m	Device MAC Address
%M	Device MAC Address without dots
%d	date-time
%t	timestamp (number of seconds from 01/01/1970)
%u	timestamp (number of milliseconds from 01/01/1970)
%b	bulk (format specified in "Publish Bulk Format")
%f	Inserts an ID instead of the variable name (see table)
%n	Tag name (only for "Publish Bulk Format")
%v	Tag value (only in "Publish Bulk Format")
%j[field]	Adds double quotes " to [field]. The double quotes represent a string in JSON

Note: the %f placeholder adds a unique ID to the variable to be published according to the following table:

%f (ID)	VARIABLE	EXPLANATION	TIPO
1	V1N	Voltage between Phase 1 and neutral	READ
2	V1N_AVG	Phase 1 to Neutral Voltage (in demand time)	READ
3	V1N_MIN	Minimum voltage between Phase 1 and neutral (from switch-on)	READ
4	V1N_MAX	Maximum voltage between Phase 1 and neutral (from switch-on)	READ
5	V1N_AVG_MIN	Phase 1 to minimum neutral voltage (in demand time)	READ
6	V1N_AVG_MAX	Phase 1 to maximum neutral voltage (in demand time)	READ
7	V2N	Voltage between Phase 2 and neutral	READ
8	V2N_AVG	Phase 2 to Neutral Voltage (in demand time)	READ
9	V2N_MIN	Minimum voltage between Phase 2 and neutral (from switch-on)	READ
10	V2N_MAX	Maximum voltage between Phase 2 and neutral (from switch-on)	READ
11	V2N_AVG_MIN	Phase 2 to minimum neutral voltage (in demand time)	READ
12	V2N_AVG_MAX	Phase 2 to maximum neutral voltage (in demand time)	READ
13	V3N	Voltage between Phase 3 and neutral	READ
14	V3N_AVG	Phase 3 to Neutral Voltage (in demand time)	READ
15	V3N_MIN	Minimum voltage between Phase 3 and neutral (from switch-on)	READ
16	V3N_MAX	Maximum voltage between Phase 3 and neutral (from switch-on)	READ
17	V3N_AVG_MIN	Phase 3 to minimum neutral voltage (in demand time)	READ
18	V3N_AVG_MAX	Phase 3 to maximum neutral voltage (in demand time)	READ
19	AN	Neutral Current	READ

20	AN_AVG	Neutral Current (on demand time)	READ
21	AN_MIN	Minimum neutral current (from switch-on)	READ
22	AN_MAX	Maximum neutral current (from switch-on)	READ
23	AN_AVG_MIN	Minimum neutral current (in demand time)	READ
24	AN_AVG_MAX	Maximum neutral current (in demand time)	READ
25	V12	Phase-to-phase voltage between Phase 1 and 2	READ
26	V12_AVG	Phase-to-phase voltage between Phase 1 and 2 (in demand time)	READ
27	V12_MIN	Minimum phase-to-phase voltage between Phase 1 and 2 (from switch-on)	READ
28	V12_MAX	Maximum phase-to-phase voltage between Phase 1 and 2 (from switch-on)	READ
29	V12_AVG_MIN	Phase-to-phase voltage between minimum Phase 1 and 2 (in demand time)	READ
30	V12_AVG_MAX	Phase-to-phase voltage between maximum Phase 1 and 2 (in demand time)	READ
31	V23	Phase-to-phase voltage between Phase 2 and 3	READ
32	V23_AVG	Phase-to-phase voltage between Phase 2 and 3 (in demand time)	READ
33	V23_MIN	Minimum phase-to-phase voltage between Phase 2 and 3 (from switch-on)	READ
34	V23_MAX	Maximum phase-to-phase voltage between Phase 2 and 3 (from switch-on)	READ
35	V23_AVG_MIN	Phase-to-phase voltage between minimum Phase 2 and 3 (in demand time)	READ
36	V23_AVG_MAX	Phase-to-phase voltage between maximum Phase 2 and 3 (in demand time)	READ
37	V31	Phase-to-phase voltage between Phase 3 and 1	READ
38	V31_AVG	Phase-to-phase voltage between Phase 3 and 1 (in demand time)	READ
39	V31_MIN	Minimum phase-to-phase voltage between Phase 3 and 1 (from switch-on)	READ
40	V31_MAX	Maximum phase-to-phase voltage between Phase 3 and 1 (from switch-on)	READ
41	V31_AVG_MIN	Phase-to-phase voltage between minimum Phase 3 and 1 (in demand time)	READ
42	V31_AVG_MAX	Phase-to-phase voltage between maximum Phase 3 and 1 (in demand time)	READ
43	Vsys	System voltage:	READ
44	Vsys_AVG	System voltage (in demand time)	READ
45	Vsys_MIN	Minimum system voltage (from switch-on)	READ
46	Vsys_MAX	Maximum system voltage (from switch-on)	READ
47	Vsys_AVG_MIN	Minimum system voltage (in demand time)	READ
48	Vsys_AVG_MAX	Maximum system voltage (in demand time)	READ
49	A1	Phase 1 current	READ
50	A1_AVG	Phase 1 current (in demand time)	READ
51	A1_MIN	Minimum Phase 1 current (from switch-on)	READ
52	A1_MAX	Maximum Phase 1 current (from switch-on)	READ
53	A1_AVG_MIN	Minimum Phase 1 current (in demand time)	READ

54	A1_AVG_MAX	Maximum Phase 1 current (in demand time)	READ
55	A2	Phase 2 current	READ
56	A2_AVG	Phase 2 current (in demand time)	READ
57	A2_MIN	Minimum Phase 2 current (from switch-on)	READ
58	A2_MAX	Maximum Phase 2 current (from switch-on)	READ
59	A2_AVG_MIN	Minimum Phase 2 current (in demand time)	READ
60	A2_AVG_MAX	Maximum Phase 2 current (in demand time)	READ
61	A3	Phase 3 current	READ
62	A3_AVG	Phase 3 current (in demand time)	READ
63	A3_MIN	Minimum Phase 3 current (from switch-on)	READ
64	A3_MAX	Maximum Phase 3 current (from switch-on)	READ
65	A3_AVG_MIN	Minimum Phase 3 current (in demand time)	READ
66	A3_AVG_MAX	Maximum Phase 3 current (in demand time)	READ
67	Asys	System current	READ
68	Asys_AVG	System current (in demand time)	READ
69	Asys_MIN	Minimum system current (from switch-on)	READ
70	Asys_MAX	Maximum system current (from switch-on)	READ
71	Asys_AVG_MIN	Minimum system current (in demand time)	READ
72	Asys_AVG_MAX	Maximum system current (in demand time)	READ
73	P1	Phase 1 Active power	READ
74	P1_AVG	Phase 1 active power (in demand time)	READ
75	P1_MIN	Minimum Phase 1 active power (from switch-on)	READ
76	P1_MAX	Maximum Phase 1 active power (from switch-on)	READ
77	P1_AVG_MIN	Minimum Phase 1 active power (in demand time)	READ
78	P1_AVG_MAX	Maximum Phase 1 active power (in demand time)	READ
79	P2	Phase 2 Active power	READ
80	P2_AVG	Phase 2 active power (in demand time)	READ
81	P2_MIN	Minimum Phase 2 active power (from switch-on)	READ
82	P2_MAX	Maximum Phase 2 active power (from switch-on)	READ
83	P2_AVG_MIN	Minimum Phase 2 active power (in demand time)	READ
84	P2_AVG_MAX	Maximum Phase 2 active power (in demand time)	READ
85	P3	Phase 3 Active power	READ
86	P3_AVG	Phase 3 active power (in demand time)	READ
87	P3_MIN	Minimum Phase 3 active power (from switch-on)	READ
88	P3_MAX	Maximum Phase 3 active power (from switch-on)	READ
89	P3_AVG_MIN	Minimum Phase 3 active power (in demand time)	READ
90	P3_AVG_MAX	Maximum Phase 3 active power (in demand time)	READ
91	Psys	System Active power	READ
92	Psys_AVG	System active power (in demand time)	READ
93	Psys_MIN	Minimum system active power (from switch-on)	READ
94	Psys_MAX	Maximum system active power (from switch-on)	READ
95	Psys_AVG_MIN	Minimum system active power (in demand time)	READ
96	Psys_AVG_MAX	Maximum system active power (in demand time)	READ

97	S1	Phase 1 apparent power	READ
98	S1_AVG	Phase 1 apparent power (in demand time)	READ
99	S1_MIN	Minimum Phase 1 apparent power (from switch-on)	READ
100	S1_MAX	Maximum Phase 1 apparent power (from switch-on)	READ
101	S1_AVG_MIN	Minimum Phase 1 apparent power (in demand time)	READ
102	S1_AVG_MAX	Maximum Phase 1 apparent power (in demand time)	READ
103	S2	Phase 2 apparent power	READ
104	S2_AVG	Phase 2 apparent power (in demand time)	READ
105	S2_MIN	Minimum Phase 2 apparent power (from switch-on)	READ
106	S2_MAX	Maximum Phase 2 apparent power (from switch-on)	READ
107	S2_AVG_MIN	Minimum Phase 2 apparent power (in demand time)	READ
108	S2_AVG_MAX	Maximum Phase 2 apparent power (in demand time)	READ
109	S3	Phase 3 apparent power	READ
110	S3_AVG	Phase 3 apparent power (in demand time)	READ
111	S3_MIN	Minimum Phase 3 apparent power (from switch-on)	READ
112	S3_MAX	Maximum Phase 3 apparent power (from switch-on)	READ
113	S3_AVG_MIN	Minimum Phase 3 apparent power (in demand time)	READ
114	S3_AVG_MAX	Maximum Phase 3 apparent power (in demand time)	READ
115	Ssys	System apparent power	READ
116	Ssys_AVG	System apparent power (in demand time)	READ
117	Ssys_MIN	Minimum system apparent power (from switch-on)	READ
118	Ssys_MAX	Maximum system apparent power (from switch-on)	READ
119	Ssys_AVG_MIN	Minimum system apparent power (in demand time)	READ
120	Ssys_AVG_MAX	Maximum system apparent power (in demand time)	READ
121	Q1	Phase 1 Reactive power	READ
122	Q1_AVG	Phase 1 reactive power (in demand time)	READ
123	Q1_MIN	Minimum Phase 1 reactive power (from switch-on)	READ
124	Q1_MAX	Maximum Phase 1 reactive power (from switch-on)	READ
125	Q1_AVG_MIN	Minimum Phase 1 reactive power (in demand time)	READ
126	Q1_AVG_MAX	Maximum Phase 1 reactive power (in demand time)	READ
127	Q2	Phase 2 Reactive power	READ
128	Q2_AVG	Phase 2 reactive power (in demand time)	READ
129	Q2_MIN	Minimum Phase 2 reactive power (from switch-on)	READ
130	Q2_MAX	Maximum Phase 2 reactive power (from switch-on)	READ
131	Q2_AVG_MIN	Minimum Phase 2 reactive power (in demand time)	READ
132	Q2_AVG_MAX	Maximum Phase 2 reactive power (in demand time)	READ
133	Q3	Phase 3 Reactive power	READ
134	Q3_AVG	Phase 3 reactive power (in demand time)	READ
135	Q3_MIN	Minimum Phase 3 reactive power (from switch-on)	READ
136	Q3_MAX	Maximum Phase 3 reactive power (from switch-on)	READ
137	Q3_AVG_MIN	Minimum Phase 3 reactive power (in demand time)	READ
138	Q3_AVG_MAX	Maximum Phase 3 reactive power (in demand time)	READ
139	Qsys	System Reactive power	READ

140	Qsys_AVG	System reactive power (in demand time)	READ
141	Qsys_MIN	Minimum system reactive power (from switch-on)	READ
142	Qsys_MAX	Maximum system reactive power (from switch-on)	READ
143	Qsys_AVG_MIN	Minimum system reactive power (in demand time)	READ
144	Qsys_AVG_MAX	Maximum system reactive power (in demand time)	READ
145	TPF1	Phase 1 Power factor	READ
146	TPF1_AVG	Phase 1 power factor (in demand time)	READ
147	TPF1_MIN	Minimum Phase 1 power factor (from switch-on)	READ
148	TPF1_MAX	Maximum Phase 1 power factor (from switch-on)	READ
149	TPF1_AVG_MIN	Minimum Phase 1 power factor (in demand time)	READ
150	TPF1_AVG_MAX	Maximum Phase 1 power factor (in demand time)	READ
151	TPF2	Phase 2 Power factor	READ
152	TPF2_AVG	Phase 2 power factor (in demand time)	READ
153	TPF2_MIN	Minimum Phase 2 power factor (from switch-on)	READ
154	TPF2_MAX	Maximum Phase 2 power factor (from switch-on)	READ
155	TPF2_AVG_MIN	Minimum Phase 2 power factor (in demand time)	READ
156	TPF2_AVG_MAX	Maximum Phase 2 power factor (in demand time)	READ
157	TPF3	Phase 3 Power factor	READ
158	TPF3_AVG	Phase 3 power factor (in demand time)	READ
159	TPF3_MIN	Minimum Phase 3 power factor (from switch-on)	READ
160	TPF3_MAX	Maximum Phase 3 power factor (from switch-on)	READ
161	TPF3_AVG_MIN	Minimum Phase 3 power factor (in demand time)	READ
162	TPF3_AVG_MAX	Maximum Phase 3 power factor (in demand time)	READ
163	TPFsys	System Power factor	READ
164	TPFsys_AVG	System power factor (in demand time)	READ
165	TPFsys_MIN	Minimum system power factor (from switch-on)	READ
166	TPFsys_MAX	Minimum system power factor (from switch-on)	READ
167	TPFsys_AVG_MIN	Minimum system power factor (in demand time)	READ
168	TPFsys_AVG_MAX	Maximum system power factor (in demand time)	READ
169	THD-V1N	Voltage THD (Total Harmonic Distortion) between Phase 1 and neutral	READ
170	THD-V1N_AVG	Voltage THD between Phase 1 and neutral (in demand time)	READ
171	THD-V1N_MIN	Minimum voltage THD between Phase 1 and neutral (from switch-on)	READ
172	THD-V1N_MAX	Maximum voltage THD between Phase 1 and neutral (from switch-on)	READ
173	THD-V1N_AVG_MIN	Minimum voltage THD between Phase 1 and neutral (in demand time)	READ
174	THD-V1N_AVG_MAX	Maximum voltage THD between Phase 1 and neutral (in demand time)	READ
175	THD-V2N	Voltage THD between Phase 2 and neutral	READ
176	THD-V2N_AVG	Voltage THD between Phase 2 and neutral (in demand time)	READ
177	THD-V2N_MIN	Minimum voltage THD between Phase 2 and neutral (from switch-on)	READ

178	THD-V2N_MAX	Maximum voltage THD between Phase 2 and neutral (from switch-on)	READ
179	THD-V2N_AVG_MIN	Minimum voltage THD between Phase 2 and neutral (in demand time)	READ
180	THD-V2N_AVG_MAX	Maximum voltage THD between Phase 2 and neutral (in demand time)	READ
181	THD-V3N	Voltage THD between Phase 3 and neutral	READ
182	THD-V3N_AVG	Voltage THD between Phase 3 and neutral (in demand time)	READ
183	THD-V3N_MIN	Minimum voltage THD between Phase 3 and neutral (from switch-on)	READ
184	THD-V3N_MAX	Maximum voltage THD between Phase 3 and neutral (from switch-on)	READ
185	THD-V3N_AVG_MIN	Minimum voltage THD between Phase 3 and neutral (in demand time)	READ
186	THD-V3N_AVG_MAX	Maximum voltage THD between Phase 3 and neutral (in demand time)	READ
187	f	Phase frequency (read from Phase 1)	READ
188	THD-A1N	Phase 1 current THD	READ
189	THD-A1N_AVG	Phase 1 current THD (in demand time)	READ
190	THD-A1N_MIN	Minimum Phase 1 current THD (from switch-on)	READ
191	THD-A1N_MAX	Maximum Phase 1 current THD (from switch-on)	READ
192	THD-A1N_AVG_MIN	Minimum Phase 1 current THD (in demand time)	READ
193	THD-A1N_AVG_MAX	Maximum Phase 1 current THD (in demand time)	READ
194	THD-A2N	Phase 2 current THD	READ
195	THD-A2N_AVG	Phase 2 current THD (in demand time)	READ
196	THD-A2N_MIN	Minimum Phase 2 current THD (from switch-on)	READ
197	THD-A2N_MAX	Maximum Phase 2 current THD (from switch-on)	READ
198	THD-A2N_AVG_MIN	Minimum Phase 2 current THD (in demand time)	READ
199	THD-A2N_AVG_MAX	Maximum Phase 2 current THD (in demand time)	READ
200	THD-A3N	Phase 3 current THD	READ
201	THD-A3N_AVG	Phase 3 current THD (in demand time)	READ
202	THD-A3N_MIN	Minimum Phase 3 current THD (from switch-on)	READ
203	THD-A3N_MAX	Maximum Phase 3 current THD (from switch-on)	READ
204	THD-A3N_AVG_MIN	Minimum Phase 3 current THD (in demand time)	READ
205	THD-A3N_AVG_MAX	Maximum Phase 3 current THD (in demand time)	READ
206	+WH1	Phase 1 positive active energy	READ
207	+WH2	Phase 2 positive active energy	READ
208	+WH3	Phase 3 positive active energy	READ
209	+Wh	Total positive active energy	READ
210	-WH1	Phase 1 negative active energy	READ

211	-WH2	Phase 2 negative active energy	READ
212	-WH3	Phase 3 negative active energy	READ
213	-Wh	Total negative active energy	READ
214	VAh1	Phase 1 apparent energy	READ
215	VAh2	Phase 2 apparent energy	READ
216	VAh3	Phase 3 apparent energy	READ
217	VAh	Total apparent energy	READ
218	+VARh1-L[Q1]	Phase 1 positive inductive reactive energy (Q1)	READ
219	+VARh2-L[Q1]	Phase 2 positive inductive reactive energy (Q1)	READ
220	+VARh3-L[Q1]	Phase 3 positive inductive reactive energy (Q1)	READ
221	+VARh-L[Q1]	Total positive inductive reactive energy (Q1)	READ
222	-VARh1-C[Q4]	Phase 1 negative capacitive reactive energy (Q4)	READ
223	-VARh2-C[Q4]	Phase 2 negative capacitive reactive energy (Q4)	READ
224	-VARh3-C[Q4]	Phase 3 negative capacitive reactive energy (Q4)	READ
225	-VARh-C[Q4]	Total negative capacitive reactive energy (Q4)	READ
226	-VARh1-L[Q3]	Phase 1 negative inductive reactive energy (Q3)	READ
227	-VARh2-L[Q3]	Phase 2 negative inductive reactive energy (Q3)	READ
228	-VARh3-L[Q3]	Phase 3 negative inductive reactive energy (Q3)	READ
229	-VARh-L[Q3]	Total negative inductive reactive energy (Q3)	READ
230	+VARh1-C[Q2]	Phase 1 positive capacitive reactive energy (Q2)	READ
231	+VARh2-C[Q2]	Phase 2 positive capacitive reactive energy (Q2)	READ
232	+VARh3-C[Q2]	Phase 3 positive capacitive reactive energy (Q2)	READ
233	+VARh-C[Q2]	Total positive capacitive reactive energy (Q2)	READ
234	Wh	Total active energy	READ
235	VARh	Total reactive energy	READ
236	VARh-L[Q1Q3]	Total inductive reactive energy (Q1+Q3)	READ
237	VARh-C[Q2Q4]	Total capacitive reactive energy (Q2+Q4)	READ
238	VAh	Total apparent energy	READ
239	COUNTER 1	Input 1 pulse counter	READ
240	COUNTER 2	Input 2 pulse counter	READ
241	DIGITAL_IN_1	Digital Input 1	READ
242	DIGITAL_IN_2	Digital Input 2	READ
243	DIGITAL_OUT_1	Digital output 1	READ/ WRITE
244	DIGITAL_OUT_2	Digital output 2	READ/ WRITE
245	ANALOG OUT	Value to load on analog output (R203 models only) in uA or mV	READ/ WRITE
246	COMMAND	Command register. Supported commands: 260 decimal to reset MIN/MAX 259 decimal to reset AVG demand time values 261 decimal to reset Energy Counters	READ/ WRITE
247	TOT KVARh L1	Phase 1 total reactive energy	READ
248	TOT KVARh L2	Phase 2 total reactive energy	READ

249	TOT KVARh L3	Phase 3 total reactive energy	READ
250	STATUS	Device status bit BIT0 -> Cyclic phase sense error (1 ERR, 0 OK) BIT1 -> ALARM (1 ACTIVE, 0 NOT ACTIVE) BIT2 -> DOUT1 status (1 ACTIVE, 0 NOT ACTIVE) BIT3 -> DOUT2 status (1 ACTIVE, 0 NOT ACTIVE) BIT4 -> DIN1 STATUS (1 high, 0 low) BIT5 -> DIN2 STATUS (1 high, 0 low) BIT6 -> Current Cutoff (1 active, 0 inactive) BIT 7 -> Current error L1 (1 CT connected reverse, 0 CT connected OK) BIT 8 -> Current error L2 (1 CT connected reverse, 0 CT connected OK) BIT 9 -> Current error L3 (1 CT connected inverted, 0 CT connected OK) BIT 10 -> Line 1 Voltage/Current connection error (1 Error, 0 OK) BIT 11 -> Connection error Line 2 Voltage/Current (1 Error, 0 OK) BIT 12 -> Connection error Line 3 Voltage/Current (1 Error, 0 OK)	READ
251	Wh1	Phase 1 total active energy	READ
252	Wh2	Phase 2 total active energy	READ
253	Wh3	Phase 3 total active energy	READ

PUBLISH PAYLOAD FOR EVENT

Selects the format to be used for the payload using the following table:

%c	Device Client ID
%m	Device MAC Address
%M	Device MAC Address without dots
%d	date-time
%t	timestamp (number of seconds from 01/01/1970)
%u	timestamp (number of milliseconds from 01/01/1970)
%x	Text of the event
%j[field]	Adds double quotes " to [field]. The double quotes represent a string in JSON

16.11. SYSTEM CONNECTION SECTION -> P2P

P2P SERVER PORT (MODBUS models only) (default: 50026)

Sets the communication port for the P2P server.

16.12. ANALOG AND DIGITAL OUTPUT SETUP SECTION

ANALOG OUTPUT RETRANSMITTED PHASE

Selects which phase is brought to the analog output (selectable between L1, L2, L3)

ANALOG OUTPUT RETRANSMITTED VALUE

Selects which variable is brought to the analog output (selectable between voltage TRUE RMS, current TRUE RMS, active power, power factor, reactive factor, apparent power, frequency)

DIGITAL OUTPUT LOGIC

Selects the output logic (normally high or low).

DIGITAL OUTPUT FUNCTION

Select the type of function the digital output is to perform.

You can choose from:

Energy Direction

It outputs the polarity (+/-) of the active power via the digital output.

Counter

Generates a pulse when the selected variable increases.

Event

This is triggered if the event specified in the data logger section occurs.

Return Event

This is triggered when the output from the event specified in the data logger section occurs.

Current Overload

It is activated if the current exceeds the set peak value.

Manual

The digital output is controlled by a Modbus register.

Event State

It is activated if the event specified in the data logger section occurs, and deactivated if the event specified in the data logger section ends.

DIGITAL OUTPUT SOURCE

Select the variable to be sent to the digital output..

16.13. INPUT DIGITAL SETUP SECTION***DIGITAL INPUT 1 MODE***

Selects the behaviour of digital input 1 if input or start/stop for the data logger.

In the "start/stop data logger" mode, when the digital input goes high the data logger starts recording (start), when the digital input goes low the data logger stops (stop).

DIGITAL INPUT 2 MODE

Selects the behaviour of digital input 2 if input or start/stop for the data logger.

In the "start/stop data logger" mode, when the digital input goes high the data logger starts recording (start), when the digital input goes low the data logger stops (stop).

DIGITAL INPUT FILTER [ms]

Sets the filter time for digital inputs, used as filtering for counters.

CONNECTIONS DIAGNOSTIC SECTION
In this section you can check if the connection to the device has been made correctly.

It is also possible to exchange the CURRENT - VOLTAGE relationship of each phase without rewiring the system.

In the case of particular connections, the CONNECTION DIAGNOSTIC parameter can be configured to "DISABLE" so that the system ignores connection errors.

MQTT STATUS

Indicates the status of the MQTT communication with the date/time of the last successful communication.

CA CERTIFICATE FILE (.crt)

File that represents the Root CA Certificate

CLIENT CERTIFICATE FILE (.crt)

File that represents the Client Certificate

CLIENT KEY FILE (.key)

File that represents the Client key

With the following configuration:

MAX FAILURE COUNTER	3	<input type="text" value="3"/>
WAIT AFTER FAILURE (minutes)	30	<input type="text" value="30"/>
CLIENT ID	R203 MQTT Client	<input type="text" value="R203 MQTT Client"/>
BROKER HOST	test.mosquitto.org	<input type="text" value="test.mosquitto.org"/>
BROKER PORT	1883	<input type="text" value="1883"/>
USE WEBSOCKETS	OFF	<input type="button" value="OFF v"/>
KEEP ALIVE INTERVAL (seconds)	30	<input type="text" value="30"/>
CLEAN SESSION	OFF	<input type="button" value="OFF v"/>
MESSAGE RETAIN	OFF	<input type="button" value="OFF v"/>
QUALITY OF SERVICE	QoS 0	<input type="button" value="QoS 0 v"/>
AUTHENTICATION	OFF	<input type="button" value="OFF v"/>
USERNAME	admin	<input type="text" value="admin"/>
PASSWORD	admin	<input type="text" value="admin"/>
SSL/TLS	OFF	<input type="button" value="OFF v"/>
CLIENT CERTIFICATE REQUIRED	OFF	<input type="button" value="OFF v"/>
CHECK CERTIFICATES	OFF	<input type="button" value="OFF v"/>
LOG ON CHANGE	OFF	<input type="button" value="OFF v"/>
PUBLISH WITH MULTIPLE TAGS	OFF	<input type="button" value="OFF v"/>
PUBLISH TOPIC FOR LOGS	seneca/%c/data	<input type="text" value="seneca/%c/data"/>
PUBLISH PAYLOAD FOR LOGS	{"t":%jt,"v":[%b]}	<input t\":%jt,\"v\":[%b]}"="" type="text" value="{\"/>
PUBLISH BULK FORMAT	{"n":%jn,"v":%jv}	<input n\":%jn,\"v\":%jv}"="" type="text" value="{\"/>
PUBLISH TOPIC FOR EVENT	seneca/%c/event	<input type="text" value="seneca/%c/event"/>
PUBLISH PAYLOAD FOR EVENT	{%x}	<input type="text" value="{%x}"/>
MQTT STATUS	 07/12/2023 16:36:02	
<input type="button" value="REBOOT"/>	<input type="button" value="FACTORY DEFAULT"/>	<input type="button" value="APPLY"/>

For example, you will get:

```
1 - {
2   "t": "1701966872",
3   "v": [
4     {
5       "n": "V31_MIN",
6       "v": "0.000"
7     },
8     {
9       "n": "V2N_AVG_MIN",
10      "v": "0.581"
11    },
12    {
13      "n": "V2N_AVG_MAX",
14      "v": "34.850"
15    },
16    {
17      "n": "V3N",
18      "v": "35.052"
19    },
20    {
21      "n": "V23_AVG_MAX",
22      "v": "0.037"
23    },
24    {
25      "n": "V3N_MIN",
26      "v": "34.611"
27    },
28    {
29      "n": "V3N_MAX",
30      "v": "35.092"
31    },
32    {
33      "n": "V31_AVG_MAX",
34      "v": "0.352"
35    },
36    {
37      "n": "Vsys",
38      "v": "2.145"
39    },
40    {
41      "n": "Vsys_AVG",
42      "v": "0.250"
43    },
44    {
```

With the following configuration:

	CURRENT	UPDATED
NOTE: Log Publish Period is given by "DATA LOGGER SAMPLE TIME" parameter (see page "Setup Datalogger").		
MAX FAILURE COUNTER	3	<input type="text" value="3"/>
WAIT AFTER FAILURE (minutes)	30	<input type="text" value="30"/>
CLIENT ID	R203 MQTT Client	<input type="text" value="R203 MQTT Client"/>
BROKER HOST	test.mosquitto.org	<input type="text" value="test.mosquitto.org"/>
BROKER PORT	1883	<input type="text" value="1883"/>
USE WEBSOCKETS	OFF	<input type="text" value="OFF"/>
KEEP ALIVE INTERVAL (seconds)	30	<input type="text" value="30"/>
CLEAN SESSION	OFF	<input type="text" value="OFF"/>
MESSAGE RETAIN	OFF	<input type="text" value="OFF"/>
QUALITY OF SERVICE	QoS 0	<input type="text" value="QoS 0"/>
AUTHENTICATION	OFF	<input type="text" value="OFF"/>
USERNAME	admin	<input type="text" value="admin"/>
PASSWORD	admin	<input type="text" value="admin"/>
SSL/TLS	OFF	<input type="text" value="OFF"/>
CLIENT CERTIFICATE REQUIRED	OFF	<input type="text" value="OFF"/>
CHECK CERTIFICATES	OFF	<input type="text" value="OFF"/>
LOG ON CHANGE	OFF	<input type="text" value="OFF"/>
PUBLISH WITH MULTIPLE TAGS	ON	<input type="text" value="ON"/>
PUBLISH TOPIC FOR LOGS	seneca/%c/data	<input type="text" value="seneca/%c/data"/>
PUBLISH PAYLOAD FOR LOGS	{"n":%jn,"v":%jv}	<input n\":%jn,\"v\":%jv}"="" type="text" value="{\"/>
PUBLISH BULK FORMAT	{"n":%jn,"v":%jv}	<input n\":%jn,\"v\":%jv}"="" type="text" value="{\"/>
PUBLISH TOPIC FOR EVENT	seneca/%c/event	<input type="text" value="seneca/%c/event"/>
PUBLISH PAYLOAD FOR EVENT	{%x}	<input type="text" value="{%x}"/>
MQTT STATUS	● 07/12/2023 16:38:16	
REBOOT	FACTORY DEFAULT	APPLY

Note the “PUBLISH PAYLOAD FOR LOGS” parameter, it will send a whole series of packets of the type:

```
1 - {  
2   "n": "Vsys_AVG_MIN",  
3   "v": "0.000"  
4 }
```

17. DEVICE CONFIGURATION VIA WEBSERVER (ETHERNET/IP, PROFINET IO, OPC-UA PROTOCOL MODELS ONLY)

To configure the device, access the web server and select the section you are interested in.

After a modification to the configuration has been made, the changes must be confirmed with the "**APPLY**" button entering the administrator account and password.

The **Reboot** button reboots the device (not necessary in the event of a configuration change).

The **Default** button returns all the page parameters to the default settings.

17.1. COMMUNICATION SETUP SECTION

DHCP (ETH) (default: Disabled)

Sets the DHCP client to get an IP address automatically.

IP ADDRESS STATIC (ETH) (default: 192.168.90.101)

Sets the device static address. Careful not to enter devices with the same IP address into the same network.

IP MASK STATIC (ETH) (default: 255.255.255.0)

Sets the mask for the IP network.

GATEWAY ADDRESS STATIC (ETH) (default: 192.168.90.1)

Sets the gateway address.

DNS (default: 8.8.8.8)

Set the Domain Name System.

PROTECT CONFIGURATION (default: Disabled)

Allows you to enable or disable password protection for reading and writing the configuration (including the IP address) using the Easy Setup 2 software or Seneca Discovery Tool. The password is the same one that allows accessing the web server.

ATTENTION!

**IF THE CONFIGURATION PROTECTION IS ENABLED IT WILL BE IMPOSSIBLE TO READ/WRITE THE CONFIGURATION OF THE DEVICE WITHOUT KNOWING THE ADMINISTRATOR PASSWORD.
IF THE PASSWORD IS LOST, IT WILL BE POSSIBLE TO RETURN THE DEVICE TO DEFAULT USING THE DIP SWITCHES**

WEBSERVER ACCOUNT NAME (default: admin)

Sets the user name to access the web server.

USER ACCOUNT CONFIGURATION/WEBSERVER PASSWORD (default: admin)

Sets the password to access the webserver and to read/write the configuration (if enabled).

WEB SERVER PORT (default: 80)

Sets the communication port for the web server.

17.2. MEASURES SETUP SECTION**CONNECTION TYPE**

Sets the type of connection to make.

CT TYPE

Selects the type of sensor and the value of the TA secondary to be used between:

TA with current output

TA with MV output

Rogowski sensor

CT RATIO

Sets any TA ratio, the value to enter is related to the primary, example:

If a 50/5 TA has been installed, the value 50 must be entered as primary with the value 5 on the "TA TYPE" parameter.

VT TYPE

Sets the type of voltage transformer

NETWORK FREQUENCY [Hz]

Sets the system to 50 or 60 Hz.

AVERAGE POWER WINDOW

Sets the time on which to measure the average values

USER CALIBRATION VOLTAGE

Sets a possible multiplication coefficient for the voltage measurement.

USER CALIBRATION CURRENT

Sets a possible multiplication coefficient for the current measurement.

CUTOFF CURRENT [A]

Sets a current value (on the primary) below which counters are stopped.

USER CALIBRATION ACTIVE ENERGY

Sets a possible multiplication coefficient for the active energy.

USER CALIBRATION REACTIVE ENERGY

Sets a possible multiplication coefficient for the reactive energy.

ANALOG OUTPUT TYPE

Selects the type of analog output between voltage and current

17.3. CONNECTION DIAGNOSTIC SECTION

In this section you can check if the connection to the device has been made correctly.

It is also possible to exchange the CURRENT - VOLTAGE relationship of each phase without rewiring the system.

In the case of particular connections, the CONNECTION DIAGNOSTIC parameter can be configured to "DISABLE" so that the system ignores connection errors.

17.4. OPC-UA CONFIGURATION SECTION (OPC-UA PROTOCOL MODELS ONLY)**MAX FAILURE COUNTER**

Maximum number of errors before waiting the time of the "WAIT AFTER FAILURE" parameter

SERVER NAME

Name that identifies the server

SERVER PORT

Server port

AUTHENTICATION

Establishes whether or not to activate authentication with username and password

USERNAME

Username to be used if authentication is active

PASSWORD

Password be used if authentication is active

OPC-UA SERVER SECURITY POLICY

Set the server security policy, you can choose between:

BASIC128RSA15
BASIC256
BASIC256SHA256
AES128SHA256RSAOEP

OPC-UA SERVER MESSAGE SECURITY MODE

Select between:

NONE

SIGN
SIGN AND ENCRYPT

OPC-UA VARIABLE LIST

Select the variables to publish on the OPC-UA server, a maximum of 60 variables can be published among the following:

VARIABLE	EXPLANATION	TIPO
V1N	Voltage between Phase 1 and neutral	READ
V1N_AVG	Phase 1 to Neutral Voltage (in demand time)	READ
V1N_MIN	Minimum voltage between Phase 1 and neutral (from switch-on)	READ
V1N_MAX	Maximum voltage between Phase 1 and neutral (from switch-on)	READ
V1N_AVG_MIN	Phase 1 to minimum neutral voltage (in demand time)	READ
V1N_AVG_MAX	Phase 1 to maximum neutral voltage (in demand time)	READ
V2N	Voltage between Phase 2 and neutral	READ
V2N_AVG	Phase 2 to Neutral Voltage (in demand time)	READ
V2N_MIN	Minimum voltage between Phase 2 and neutral (from switch-on)	READ
V2N_MAX	Maximum voltage between Phase 2 and neutral (from switch-on)	READ
V2N_AVG_MIN	Phase 2 to minimum neutral voltage (in demand time)	READ
V2N_AVG_MAX	Phase 2 to maximum neutral voltage (in demand time)	READ
V3N	Voltage between Phase 3 and neutral	READ
V3N_AVG	Phase 3 to Neutral Voltage (in demand time)	READ
V3N_MIN	Minimum voltage between Phase 3 and neutral (from switch-on)	READ
V3N_MAX	Maximum voltage between Phase 3 and neutral (from switch-on)	READ
V3N_AVG_MIN	Phase 3 to minimum neutral voltage (in demand time)	READ
V3N_AVG_MAX	Phase 3 to maximum neutral voltage (in demand time)	READ
AN	Neutral Current	READ
AN_AVG	Neutral Current (on demand time)	READ
AN_MIN	Minimum neutral current (from switch-on)	READ
AN_MAX	Maximum neutral current (from switch-on)	READ
AN_AVG_MIN	Minimum neutral current (in demand time)	READ
AN_AVG_MAX	Maximum neutral current (in demand time)	READ
V12	Phase-to-phase voltage between Phase 1 and 2	READ
V12_AVG	Phase-to-phase voltage between Phase 1 and 2 (in demand time)	READ
V12_MIN	Minimum phase-to-phase voltage between Phase 1 and 2 (from switch-on)	READ
V12_MAX	Maximum phase-to-phase voltage between Phase 1 and 2 (from switch-on)	READ

V12_AVG_MIN	Phase-to-phase voltage between minimum Phase 1 and 2 (in demand time)	READ
V12_AVG_MAX	Phase-to-phase voltage between maximum Phase 1 and 2 (in demand time)	READ
V23	Phase-to-phase voltage between Phase 2 and 3	READ
V23_AVG	Phase-to-phase voltage between Phase 2 and 3 (in demand time)	READ
V23_MIN	Minimum phase-to-phase voltage between Phase 2 and 3 (from switch-on)	READ
V23_MAX	Maximum phase-to-phase voltage between Phase 2 and 3 (from switch-on)	READ
V23_AVG_MIN	Phase-to-phase voltage between minimum Phase 2 and 3 (in demand time)	READ
V23_AVG_MAX	Phase-to-phase voltage between maximum Phase 2 and 3 (in demand time)	READ
V31	Phase-to-phase voltage between Phase 3 and 1	READ
V31_AVG	Phase-to-phase voltage between Phase 3 and 1 (in demand time)	READ
V31_MIN	Minimum phase-to-phase voltage between Phase 3 and 1 (from switch-on)	READ
V31_MAX	Maximum phase-to-phase voltage between Phase 3 and 1 (from switch-on)	READ
V31_AVG_MIN	Phase-to-phase voltage between minimum Phase 3 and 1 (in demand time)	READ
V31_AVG_MAX	Phase-to-phase voltage between maximum Phase 3 and 1 (in demand time)	READ
Vsys	System voltage:	READ
Vsys_AVG	System voltage (in demand time)	READ
Vsys_MIN	Minimum system voltage (from switch-on)	READ
Vsys_MAX	Maximum system voltage (from switch-on)	READ
Vsys_AVG_MIN	Minimum system voltage (in demand time)	READ
Vsys_AVG_MAX	Maximum system voltage (in demand time)	READ
A1	Phase 1 current	READ
A1_AVG	Phase 1 current (in demand time)	READ
A1_MIN	Minimum Phase 1 current (from switch-on)	READ
A1_MAX	Maximum Phase 1 current (from switch-on)	READ
A1_AVG_MIN	Minimum Phase 1 current (in demand time)	READ
A1_AVG_MAX	Maximum Phase 1 current (in demand time)	READ
A2	Phase 2 current	READ
A2_AVG	Phase 2 current (in demand time)	READ
A2_MIN	Minimum Phase 2 current (from switch-on)	READ
A2_MAX	Maximum Phase 2 current (from switch-on)	READ
A2_AVG_MIN	Minimum Phase 2 current (in demand time)	READ
A2_AVG_MAX	Maximum Phase 2 current (in demand time)	READ
A3	Phase 3 current	READ
A3_AVG	Phase 3 current (in demand time)	READ

A3_MIN	Minimum Phase 3 current (from switch-on)	READ
A3_MAX	Maximum Phase 3 current (from switch-on)	READ
A3_AVG_MIN	Minimum Phase 3 current (in demand time)	READ
A3_AVG_MAX	Maximum Phase 3 current (in demand time)	READ
Asys	System current	READ
Asys_AVG	System current (in demand time)	READ
Asys_MIN	Minimum system current (from switch-on)	READ
Asys_MAX	Maximum system current (from switch-on)	READ
Asys_AVG_MIN	Minimum system current (in demand time)	READ
Asys_AVG_MAX	Maximum system current (in demand time)	READ
P1	Phase 1 Active power	READ
P1_AVG	Phase 1 active power (in demand time)	READ
P1_MIN	Minimum Phase 1 active power (from switch-on)	READ
P1_MAX	Maximum Phase 1 active power (from switch-on)	READ
P1_AVG_MIN	Minimum Phase 1 active power (in demand time)	READ
P1_AVG_MAX	Maximum Phase 1 active power (in demand time)	READ
P2	Phase 2 Active power	READ
P2_AVG	Phase 2 active power (in demand time)	READ
P2_MIN	Minimum Phase 2 active power (from switch-on)	READ
P2_MAX	Maximum Phase 2 active power (from switch-on)	READ
P2_AVG_MIN	Minimum Phase 2 active power (in demand time)	READ
P2_AVG_MAX	Maximum Phase 2 active power (in demand time)	READ
P3	Phase 3 Active power	READ
P3_AVG	Phase 3 active power (in demand time)	READ
P3_MIN	Minimum Phase 3 active power (from switch-on)	READ
P3_MAX	Maximum Phase 3 active power (from switch-on)	READ
P3_AVG_MIN	Minimum Phase 3 active power (in demand time)	READ
P3_AVG_MAX	Maximum Phase 3 active power (in demand time)	READ
Psys	System Active power	READ
Psys_AVG	System active power (in demand time)	READ
Psys_MIN	Minimum system active power (from switch-on)	READ
Psys_MAX	Maximum system active power (from switch-on)	READ
Psys_AVG_MIN	Minimum system active power (in demand time)	READ
Psys_AVG_MAX	Maximum system active power (in demand time)	READ
S1	Phase 1 apparent power	READ
S1_AVG	Phase 1 apparent power (in demand time)	READ
S1_MIN	Minimum Phase 1 apparent power (from switch-on)	READ
S1_MAX	Maximum Phase 1 apparent power (from switch-on)	READ
S1_AVG_MIN	Minimum Phase 1 apparent power (in demand time)	READ
S1_AVG_MAX	Maximum Phase 1 apparent power (in demand time)	READ
S2	Phase 2 apparent power	READ
S2_AVG	Phase 2 apparent power (in demand time)	READ
S2_MIN	Minimum Phase 2 apparent power (from switch-on)	READ

S2_MAX	Maximum Phase 2 apparent power (from switch-on)	READ
S2_AVG_MIN	Minimum Phase 2 apparent power (in demand time)	READ
S2_AVG_MAX	Maximum Phase 2 apparent power (in demand time)	READ
S3	Phase 3 apparent power	READ
S3_AVG	Phase 3 apparent power (in demand time)	READ
S3_MIN	Minimum Phase 3 apparent power (from switch-on)	READ
S3_MAX	Maximum Phase 3 apparent power (from switch-on)	READ
S3_AVG_MIN	Minimum Phase 3 apparent power (in demand time)	READ
S3_AVG_MAX	Maximum Phase 3 apparent power (in demand time)	READ
Ssys	System apparent power	READ
Ssys_AVG	System apparent power (in demand time)	READ
Ssys_MIN	Minimum system apparent power (from switch-on)	READ
Ssys_MAX	Maximum system apparent power (from switch-on)	READ
Ssys_AVG_MIN	Minimum system apparent power (in demand time)	READ
Ssys_AVG_MAX	Maximum system apparent power (in demand time)	READ
Q1	Phase 1 Reactive power	READ
Q1_AVG	Phase 1 reactive power (in demand time)	READ
Q1_MIN	Minimum Phase 1 reactive power (from switch-on)	READ
Q1_MAX	Maximum Phase 1 reactive power (from switch-on)	READ
Q1_AVG_MIN	Minimum Phase 1 reactive power (in demand time)	READ
Q1_AVG_MAX	Maximum Phase 1 reactive power (in demand time)	READ
Q2	Phase 2 Reactive power	READ
Q2_AVG	Phase 2 reactive power (in demand time)	READ
Q2_MIN	Minimum Phase 2 reactive power (from switch-on)	READ
Q2_MAX	Maximum Phase 2 reactive power (from switch-on)	READ
Q2_AVG_MIN	Minimum Phase 2 reactive power (in demand time)	READ
Q2_AVG_MAX	Maximum Phase 2 reactive power (in demand time)	READ
Q3	Phase 3 Reactive power	READ
Q3_AVG	Phase 3 reactive power (in demand time)	READ
Q3_MIN	Minimum Phase 3 reactive power (from switch-on)	READ
Q3_MAX	Maximum Phase 3 reactive power (from switch-on)	READ
Q3_AVG_MIN	Minimum Phase 3 reactive power (in demand time)	READ
Q3_AVG_MAX	Maximum Phase 3 reactive power (in demand time)	READ
Qsys	System Reactive power	READ
Qsys_AVG	System reactive power (in demand time)	READ
Qsys_MIN	Minimum system reactive power (from switch-on)	READ
Qsys_MAX	Maximum system reactive power (from switch-on)	READ
Qsys_AVG_MIN	Minimum system reactive power (in demand time)	READ
Qsys_AVG_MAX	Maximum system reactive power (in demand time)	READ
TPF1	Phase 1 Power factor	READ
TPF1_AVG	Phase 1 power factor (in demand time)	READ
TPF1_MIN	Minimum Phase 1 power factor (from switch-on)	READ
TPF1_MAX	Maximum Phase 1 power factor (from switch-on)	READ

TPF1_AVG_MIN	Minimum Phase 1 power factor (in demand time)	READ
TPF1_AVG_MAX	Maximum Phase 1 power factor (in demand time)	READ
TPF2	Phase 2 Power factor	READ
TPF2_AVG	Phase 2 power factor (in demand time)	READ
TPF2_MIN	Minimum Phase 2 power factor (from switch-on)	READ
TPF2_MAX	Maximum Phase 2 power factor (from switch-on)	READ
TPF2_AVG_MIN	Minimum Phase 2 power factor (in demand time)	READ
TPF2_AVG_MAX	Maximum Phase 2 power factor (in demand time)	READ
TPF3	Phase 3 Power factor	READ
TPF3_AVG	Phase 3 power factor (in demand time)	READ
TPF3_MIN	Minimum Phase 3 power factor (from switch-on)	READ
TPF3_MAX	Maximum Phase 3 power factor (from switch-on)	READ
TPF3_AVG_MIN	Minimum Phase 3 power factor (in demand time)	READ
TPF3_AVG_MAX	Maximum Phase 3 power factor (in demand time)	READ
TPFsys	System Power factor	READ
TPFsys_AVG	System power factor (in demand time)	READ
TPFsys_MIN	Minimum system power factor (from switch-on)	READ
TPFsys_MAX	Minimum system power factor (from switch-on)	READ
TPFsys_AVG_MIN	Minimum system power factor (in demand time)	READ
TPFsys_AVG_MAX	Maximum system power factor (in demand time)	READ
THD-V1N	Voltage THD (Total Harmonic Distortion) between Phase 1 and neutral	READ
THD-V1N_AVG	Voltage THD between Phase 1 and neutral (in demand time)	READ
THD-V1N_MIN	Minimum voltage THD between Phase 1 and neutral (from switch-on)	READ
THD-V1N_MAX	Maximum voltage THD between Phase 1 and neutral (from switch-on)	READ
THD-V1N_AVG_MIN	Minimum voltage THD between Phase 1 and neutral (in demand time)	READ
THD-V1N_AVG_MAX	Maximum voltage THD between Phase 1 and neutral (in demand time)	READ
THD-V2N	Voltage THD between Phase 2 and neutral	READ
THD-V2N_AVG	Voltage THD between Phase 2 and neutral (in demand time)	READ
THD-V2N_MIN	Minimum voltage THD between Phase 2 and neutral (from switch-on)	READ
THD-V2N_MAX	Maximum voltage THD between Phase 2 and neutral (from switch-on)	READ
THD-V2N_AVG_MIN	Minimum voltage THD between Phase 2 and neutral (in demand time)	READ
THD-V2N_AVG_MAX	Maximum voltage THD between Phase 2 and neutral (in demand time)	READ
THD-V3N	Voltage THD between Phase 3 and neutral	READ
THD-V3N_AVG	Voltage THD between Phase 3 and neutral (in demand time)	READ
THD-V3N_MIN	Minimum voltage THD between Phase 3 and neutral (from switch-on)	READ

THD-V3N_MAX	Maximum voltage THD between Phase 3 and neutral (from switch-on)	READ
THD-V3N_AVG_MIN	Minimum voltage THD between Phase 3 and neutral (in demand time)	READ
THD-V3N_AVG_MAX	Maximum voltage THD between Phase 3 and neutral (in demand time)	READ
f	Phase frequency (read from Phase 1)	READ
THD-A1N	Phase 1 current THD	READ
THD-A1N_AVG	Phase 1 current THD (in demand time)	READ
THD-A1N_MIN	Minimum Phase 1 current THD (from switch-on)	READ
THD-A1N_MAX	Maximum Phase 1 current THD (from switch-on)	READ
THD-A1N_AVG_MIN	Minimum Phase 1 current THD (in demand time)	READ
THD-A1N_AVG_MAX	Maximum Phase 1 current THD (in demand time)	READ
THD-A2N	Phase 2 current THD	READ
THD-A2N_AVG	Phase 2 current THD (in demand time)	READ
THD-A2N_MIN	Minimum Phase 2 current THD (from switch-on)	READ
THD-A2N_MAX	Maximum Phase 2 current THD (from switch-on)	READ
THD-A2N_AVG_MIN	Minimum Phase 2 current THD (in demand time)	READ
THD-A2N_AVG_MAX	Maximum Phase 2 current THD (in demand time)	READ
THD-A3N	Phase 3 current THD	READ
THD-A3N_AVG	Phase 3 current THD (in demand time)	READ
THD-A3N_MIN	Minimum Phase 3 current THD (from switch-on)	READ
THD-A3N_MAX	Maximum Phase 3 current THD (from switch-on)	READ
THD-A3N_AVG_MIN	Minimum Phase 3 current THD (in demand time)	READ
THD-A3N_AVG_MAX	Maximum Phase 3 current THD (in demand time)	READ
+WH1	Phase 1 positive active energy	READ
+WH2	Phase 2 positive active energy	READ
+WH3	Phase 3 positive active energy	READ
+Wh	Total positive active energy	READ
-WH1	Phase 1 negative active energy	READ
-WH2	Phase 2 negative active energy	READ
-WH3	Phase 3 negative active energy	READ
-Wh	Total negative active energy	READ
VAh1	Phase 1 apparent energy	READ
VAh2	Phase 2 apparent energy	READ
VAh3	Phase 3 apparent energy	READ
VAh	Total apparent energy	READ
+VARh1-L[Q1]	Phase 1 positive inductive reactive energy (Q1)	READ
+VARh2-L[Q1]	Phase 2 positive inductive reactive energy (Q1)	READ

+VARh3-L[Q1]	Phase 3 positive inductive reactive energy (Q1)	READ
+VARh-L[Q1]	Total positive inductive reactive energy (Q1)	READ
-VARh1-C[Q4]	Phase 1 negative capacitive reactive energy (Q4)	READ
-VARh2-C[Q4]	Phase 2 negative capacitive reactive energy (Q4)	READ
-VARh3-C[Q4]	Phase 3 negative capacitive reactive energy (Q4)	READ
-VARh-C[Q4]	Total negative capacitive reactive energy (Q4)	READ
-VARh1-L[Q3]	Phase 1 negative inductive reactive energy (Q3)	READ
-VARh2-L[Q3]	Phase 2 negative inductive reactive energy (Q3)	READ
-VARh3-L[Q3]	Phase 3 negative inductive reactive energy (Q3)	READ
-VARh-L[Q3]	Total negative inductive reactive energy (Q3)	READ
+VARh1-C[Q2]	Phase 1 positive capacitive reactive energy (Q2)	READ
+VARh2-C[Q2]	Phase 2 positive capacitive reactive energy (Q2)	READ
+VARh3-C[Q2]	Phase 3 positive capacitive reactive energy (Q2)	READ
+VARh-C[Q2]	Total positive capacitive reactive energy (Q2)	READ
Wh	Total active energy	READ
VARh	Total reactive energy	READ
VARh-L[Q1Q3]	Total inductive reactive energy (Q1+Q3)	READ
VARh-C[Q2Q4]	Total capacitive reactive energy (Q2+Q4)	READ
VAh	Total apparent energy	READ
COUNTER 1	Input 1 pulse counter	READ
COUNTER 2	Input 2 pulse counter	READ
DIGITAL_IN_1	Digital Input 1	READ
DIGITAL_IN_2	Digital Input 2	READ
DIGITAL_OUT_1	Digital output 1	READ/ WRITE
DIGITAL_OUT_2	Digital output 2	READ/ WRITE
ANALOG OUT	Value to load on analog output (R203 models only) in uA or mV	READ/ WRITE
COMMAND	Command register. Supported commands: 260 decimal to reset MIN/MAX 259 decimal to reset AVG demand time values 261 decimal to reset Energy Counters	READ/ WRITE
TOT KVARh L1	Phase 1 total reactive energy	READ
TOT KVARh L2	Phase 2 total reactive energy	READ
TOT KVARh L3	Phase 3 total reactive energy	READ
STATUS	Device status bit BIT0 -> Cyclic phase sense error (1 ERR, 0 OK) BIT1 -> ALARM (1 ACTIVE, 0 NOT ACTIVE) BIT2 -> DOUT1 status (1 ACTIVE, 0 NOT ACTIVE) BIT3 -> DOUT2 status (1 ACTIVE, 0 NOT ACTIVE) BIT4 -> DIN1 STATUS (1 high, 0 low) BIT5 -> DIN2 STATUS (1 high, 0 low) BIT6 -> Current Cutoff (1 active, 0 inactive) BIT 7 -> Current error L1 (1 CT connected reverse, 0 CT connected OK) BIT 8 -> Current error L2 (1 CT connected reverse, 0 CT connected OK)	READ

	BIT 9 -> Current error L3 (1 CT connected inverted, 0 CT connected OK) BIT 10 -> Line 1 Voltage/Current connection error (1 Error, 0 OK) BIT 11 -> Connection error Line 2 Voltage/Current (1 Error, 0 OK) BIT 12 -> Connection error Line 3 Voltage/Current (1 Error, 0 OK)	
Wh1	Phase 1 total active energy	READ
Wh2	Phase 2 total active energy	READ
Wh3	Phase 3 total active energy	READ

VARIABLE	EXPLANATION
V1N	Voltage between Phase 1 and neutral
V1N_AVG	Phase 1 to Neutral Voltage (in demand time)
V1N_MIN	Minimum voltage between Phase 1 and neutral (from switch-on)
V1N_MAX	Maximum voltage between Phase 1 and neutral (from switch-on)
V1N_AVG_MIN	Phase 1 to minimum neutral voltage (in demand time)
V1N_AVG_MAX	Phase 1 to maximum neutral voltage (in demand time)
V2N	Voltage between Phase 2 and neutral
V2N_AVG	Phase 2 to Neutral Voltage (in demand time)
V2N_MIN	Minimum voltage between Phase 2 and neutral (from switch-on)
V2N_MAX	Maximum voltage between Phase 2 and neutral (from switch-on)
V2N_AVG_MIN	Phase 2 to minimum neutral voltage (in demand time)
V2N_AVG_MAX	Phase 2 to maximum neutral voltage (in demand time)
V3N	Voltage between Phase 3 and neutral
V3N_AVG	Phase 3 to Neutral Voltage (in demand time)
V3N_MIN	Minimum voltage between Phase 3 and neutral (from switch-on)
V3N_MAX	Maximum voltage between Phase 3 and neutral (from switch-on)
V3N_AVG_MIN	Phase 3 to minimum neutral voltage (in demand time)
V3N_AVG_MAX	Phase 3 to maximum neutral voltage (in demand time)
AN	Neutral Current
AN_AVG	Neutral Current (on demand time)
AN_MIN	Minimum neutral current (from switch-on)
AN_MAX	Maximum neutral current (from switch-on)
AN_AVG_MIN	Minimum neutral current (in demand time)
AN_AVG_MAX	Maximum neutral current (in demand time)
V12	Phase-to-phase voltage between Phase 1 and 2
V12_AVG	Phase-to-phase voltage between Phase 1 and 2 (in demand time)
V12_MIN	Minimum phase-to-phase voltage between Phase 1 and 2 (from switch-on)
V12_MAX	Maximum phase-to-phase voltage between Phase 1 and 2 (from switch-on)
V12_AVG_MIN	Phase-to-phase voltage between minimum Phase 1 and 2 (in demand time)
V12_AVG_MAX	Phase-to-phase voltage between maximum Phase 1 and 2 (in demand time)

V23	Phase-to-phase voltage between Phase 2 and 3
V23_AVG	Phase-to-phase voltage between Phase 2 and 3 (in demand time)
V23_MIN	Minimum phase-to-phase voltage between Phase 2 and 3 (from switch-on)
V23_MAX	Maximum phase-to-phase voltage between Phase 2 and 3 (from switch-on)
V23_AVG_MIN	Phase-to-phase voltage between minimum Phase 2 and 3 (in demand time)
V23_AVG_MAX	Phase-to-phase voltage between maximum Phase 2 and 3 (in demand time)
V31	Phase-to-phase voltage between Phase 3 and 1
V31_AVG	Phase-to-phase voltage between Phase 3 and 1 (in demand time)
V31_MIN	Minimum phase-to-phase voltage between Phase 3 and 1 (from switch-on)
V31_MAX	Maximum phase-to-phase voltage between Phase 3 and 1 (from switch-on)
V31_AVG_MIN	Phase-to-phase voltage between minimum Phase 3 and 1 (in demand time)
V31_AVG_MAX	Phase-to-phase voltage between maximum Phase 3 and 1 (in demand time)
Vsys	System voltage:
Vsys_AVG	System voltage (in demand time)
Vsys_MIN	Minimum system voltage (from switch-on)
Vsys_MAX	Maximum system voltage (from switch-on)
Vsys_AVG_MIN	Minimum system voltage (in demand time)
Vsys_AVG_MAX	Maximum system voltage (in demand time)
A1	Phase 1 current
A1_AVG	Phase 1 current (in demand time)
A1_MIN	Minimum Phase 1 current (from switch-on)
A1_MAX	Maximum Phase 1 current (from switch-on)
A1_AVG_MIN	Minimum Phase 1 current (in demand time)
A1_AVG_MAX	Maximum Phase 1 current (in demand time)
A2	Phase 2 current
A2_AVG	Phase 2 current (in demand time)
A2_MIN	Minimum Phase 2 current (from switch-on)
A2_MAX	Maximum Phase 2 current (from switch-on)
A2_AVG_MIN	Minimum Phase 2 current (in demand time)
A2_AVG_MAX	Maximum Phase 2 current (in demand time)
A3	Phase 3 current
A3_AVG	Phase 3 current (in demand time)
A3_MIN	Minimum Phase 3 current (from switch-on)
A3_MAX	Maximum Phase 3 current (from switch-on)
A3_AVG_MIN	Minimum Phase 3 current (in demand time)
A3_AVG_MAX	Maximum Phase 3 current (in demand time)
Asys	System current

Asys_AVG	System current (in demand time)
Asys_MIN	Minimum system current (from switch-on)
Asys_MAX	Maximum system current (from switch-on)
Asys_AVG_MIN	Minimum system current (in demand time)
Asys_AVG_MAX	Maximum system current (in demand time)
P1	Phase 1 Active power
P1_AVG	Phase 1 active power (in demand time)
P1_MIN	Minimum Phase 1 active power (from switch-on)
P1_MAX	Maximum Phase 1 active power (from switch-on)
P1_AVG_MIN	Minimum Phase 1 active power (in demand time)
P1_AVG_MAX	Maximum Phase 1 active power (in demand time)
P2	Phase 2 Active power
P2_AVG	Phase 2 active power (in demand time)
P2_MIN	Minimum Phase 2 active power (from switch-on)
P2_MAX	Maximum Phase 2 active power (from switch-on)
P2_AVG_MIN	Minimum Phase 2 active power (in demand time)
P2_AVG_MAX	Maximum Phase 2 active power (in demand time)
P3	Phase 3 Active power
P3_AVG	Phase 3 active power (in demand time)
P3_MIN	Minimum Phase 3 active power (from switch-on)
P3_MAX	Maximum Phase 3 active power (from switch-on)
P3_AVG_MIN	Minimum Phase 3 active power (in demand time)
P3_AVG_MAX	Maximum Phase 3 active power (in demand time)
Psys	System Active power
Psys_AVG	System active power (in demand time)
Psys_MIN	Minimum system active power (from switch-on)
Psys_MAX	Maximum system active power (from switch-on)
Psys_AVG_MIN	Minimum system active power (in demand time)
Psys_AVG_MAX	Maximum system active power (in demand time)
S1	Phase 1 apparent power
S1_AVG	Phase 1 apparent power (in demand time)
S1_MIN	Minimum Phase 1 apparent power (from switch-on)
S1_MAX	Maximum Phase 1 apparent power (from switch-on)
S1_AVG_MIN	Minimum Phase 1 apparent power (in demand time)
S1_AVG_MAX	Maximum Phase 1 apparent power (in demand time)
S2	Phase 2 apparent power
S2_AVG	Phase 2 apparent power (in demand time)
S2_MIN	Minimum Phase 2 apparent power (from switch-on)
S2_MAX	Maximum Phase 2 apparent power (from switch-on)
S2_AVG_MIN	Minimum Phase 2 apparent power (in demand time)
S2_AVG_MAX	Maximum Phase 2 apparent power (in demand time)
S3	Phase 3 apparent power
S3_AVG	Phase 3 apparent power (in demand time)

S3_MIN	Minimum Phase 3 apparent power (from switch-on)
S3_MAX	Maximum Phase 3 apparent power (from switch-on)
S3_AVG_MIN	Minimum Phase 3 apparent power (in demand time)
S3_AVG_MAX	Maximum Phase 3 apparent power (in demand time)
Ssys	System apparent power
Ssys_AVG	System apparent power (in demand time)
Ssys_MIN	Minimum system apparent power (from switch-on)
Ssys_MAX	Maximum system apparent power (from switch-on)
Ssys_AVG_MIN	Minimum system apparent power (in demand time)
Ssys_AVG_MAX	Maximum system apparent power (in demand time)
Q1	Phase 1 Reactive power
Q1_AVG	Phase 1 reactive power (in demand time)
Q1_MIN	Minimum Phase 1 reactive power (from switch-on)
Q1_MAX	Maximum Phase 1 reactive power (from switch-on)
Q1_AVG_MIN	Minimum Phase 1 reactive power (in demand time)
Q1_AVG_MAX	Maximum Phase 1 reactive power (in demand time)
Q2	Phase 2 Reactive power
Q2_AVG	Phase 2 reactive power (in demand time)
Q2_MIN	Minimum Phase 2 reactive power (from switch-on)
Q2_MAX	Maximum Phase 2 reactive power (from switch-on)
Q2_AVG_MIN	Minimum Phase 2 reactive power (in demand time)
Q2_AVG_MAX	Maximum Phase 2 reactive power (in demand time)
Q3	Phase 3 Reactive power
Q3_AVG	Phase 3 reactive power (in demand time)
Q3_MIN	Minimum Phase 3 reactive power (from switch-on)
Q3_MAX	Maximum Phase 3 reactive power (from switch-on)
Q3_AVG_MIN	Minimum Phase 3 reactive power (in demand time)
Q3_AVG_MAX	Maximum Phase 3 reactive power (in demand time)
Qsys	System Reactive power
Qsys_AVG	System reactive power (in demand time)
Qsys_MIN	Minimum system reactive power (from switch-on)
Qsys_MAX	Maximum system reactive power (from switch-on)
Qsys_AVG_MIN	Minimum system reactive power (in demand time)
Qsys_AVG_MAX	Maximum system reactive power (in demand time)
TPF1	Phase 1 Power factor
TPF1_AVG	Phase 1 power factor (in demand time)
TPF1_MIN	Minimum Phase 1 power factor (from switch-on)
TPF1_MAX	Maximum Phase 1 power factor (from switch-on)
TPF1_AVG_MIN	Minimum Phase 1 power factor (in demand time)
TPF1_AVG_MAX	Maximum Phase 1 power factor (in demand time)
TPF2	Phase 2 Power factor
TPF2_AVG	Phase 2 power factor (in demand time)
TPF2_MIN	Minimum Phase 2 power factor (from switch-on)

TPF2_MAX	Maximum Phase 2 power factor (from switch-on)
TPF2_AVG_MIN	Minimum Phase 2 power factor (in demand time)
TPF2_AVG_MAX	Maximum Phase 2 power factor (in demand time)
TPF3	Phase 3 Power factor
TPF3_AVG	Phase 3 power factor (in demand time)
TPF3_MIN	Minimum Phase 3 power factor (from switch-on)
TPF3_MAX	Maximum Phase 3 power factor (from switch-on)
TPF3_AVG_MIN	Minimum Phase 3 power factor (in demand time)
TPF3_AVG_MAX	Maximum Phase 3 power factor (in demand time)
TPFsys	System Power factor
TPFsys_AVG	System power factor (in demand time)
TPFsys_MIN	Minimum system power factor (from switch-on)
TPFsys_MAX	Minimum system power factor (from switch-on)
TPFsys_AVG_MIN	Minimum system power factor (in demand time)
TPFsys_AVG_MAX	Maximum system power factor (in demand time)
THD-V1N	Voltage THD (Total Harmonic Distortion) between Phase 1 and neutral
THD-V1N_AVG	Voltage THD between Phase 1 and neutral (in demand time)
THD-V1N_MIN	Minimum voltage THD between Phase 1 and neutral (from switch-on)
THD-V1N_MAX	Maximum voltage THD between Phase 1 and neutral (from switch-on)
THD-V1N_AVG_MIN	Minimum voltage THD between Phase 1 and neutral (in demand time)
THD-V1N_AVG_MAX	Maximum voltage THD between Phase 1 and neutral (in demand time)
THD-V2N	Voltage THD between Phase 2 and neutral
THD-V2N_AVG	Voltage THD between Phase 2 and neutral (in demand time)
THD-V2N_MIN	Minimum voltage THD between Phase 2 and neutral (from switch-on)
THD-V2N_MAX	Maximum voltage THD between Phase 2 and neutral (from switch-on)
THD-V2N_AVG_MIN	Minimum voltage THD between Phase 2 and neutral (in demand time)
THD-V2N_AVG_MAX	Maximum voltage THD between Phase 2 and neutral (in demand time)
THD-V3N	Voltage THD between Phase 3 and neutral
THD-V3N_AVG	Voltage THD between Phase 3 and neutral (in demand time)
THD-V3N_MIN	Minimum voltage THD between Phase 3 and neutral (from switch-on)
THD-V3N_MAX	Maximum voltage THD between Phase 3 and neutral (from switch-on)
THD-V3N_AVG_MIN	Minimum voltage THD between Phase 3 and neutral (in demand time)
THD-V3N_AVG_MAX	Maximum voltage THD between Phase 3 and neutral (in demand time)
f	Phase frequency (read from Phase 1)
THD-A1N	Phase 1 current THD
THD-A1N_AVG	Phase 1 current THD (in demand time)
THD-A1N_MIN	Minimum Phase 1 current THD (from switch-on)
THD-A1N_MAX	Maximum Phase 1 current THD (from switch-on)
THD-A1N_AVG_MIN	Minimum Phase 1 current THD (in demand time)
THD-A1N_AVG_MAX	Maximum Phase 1 current THD (in demand time)
THD-A2N	Phase 2 current THD

THD-A2N_AVG	Phase 2 current THD (in demand time)
THD-A2N_MIN	Minimum Phase 2 current THD (from switch-on)
THD-A2N_MAX	Maximum Phase 2 current THD (from switch-on)
THD-A2N_AVG_MIN	Minimum Phase 2 current THD (in demand time)
THD-A2N_AVG_MAX	Maximum Phase 2 current THD (in demand time)
THD-A3N	Phase 3 current THD
THD-A3N_AVG	Phase 3 current THD (in demand time)
THD-A3N_MIN	Minimum Phase 3 current THD (from switch-on)
THD-A3N_MAX	Maximum Phase 3 current THD (from switch-on)
THD-A3N_AVG_MIN	Minimum Phase 3 current THD (in demand time)
THD-A3N_AVG_MAX	Maximum Phase 3 current THD (in demand time)
+WH1	Phase 1 positive active energy
+WH2	Phase 2 positive active energy
+WH3	Phase 3 positive active energy
+Wh	Total positive active energy
-WH1	Phase 1 negative active energy
-WH2	Phase 2 negative active energy
-WH3	Phase 3 negative active energy
-Wh	Total negative active energy
VAh1	Phase 1 apparent energy
VAh2	Phase 2 apparent energy
VAh3	Phase 3 apparent energy
VAh	Total apparent energy
+VARh1-L[Q1]	Phase 1 positive inductive reactive energy (Q1)
+VARh2-L[Q1]	Phase 2 positive inductive reactive energy (Q1)
+VARh3-L[Q1]	Phase 3 positive inductive reactive energy (Q1)
+VARh-L[Q1]	Total positive inductive reactive energy (Q1)
-VARh1-C[Q4]	Phase 1 negative capacitive reactive energy (Q4)
-VARh2-C[Q4]	Phase 2 negative capacitive reactive energy (Q4)
-VARh3-C[Q4]	Phase 3 negative capacitive reactive energy (Q4)
-VARh-C[Q4]	Total negative capacitive reactive energy (Q4)
-VARh1-L[Q3]	Phase 1 negative inductive reactive energy (Q3)
-VARh2-L[Q3]	Phase 2 negative inductive reactive energy (Q3)
-VARh3-L[Q3]	Phase 3 negative inductive reactive energy (Q3)
-VARh-L[Q3]	Total negative inductive reactive energy (Q3)
+VARh1-C[Q2]	Phase 1 positive capacitive reactive energy (Q2)
+VARh2-C[Q2]	Phase 2 positive capacitive reactive energy (Q2)
+VARh3-C[Q2]	Phase 3 positive capacitive reactive energy (Q2)
+VARh-C[Q2]	Total positive capacitive reactive energy (Q2)
Wh	Total active energy
VARh	Total reactive energy
VARh-L[Q1Q3]	Total inductive reactive energy (Q1+Q3)
VARh-C[Q2Q4]	Total capacitive reactive energy (Q2+Q4)

VAh	Total apparent energy
COUNTER 1	Input 1 pulse counter
COUNTER 2	Input 2 pulse counter
DIGITAL_IN_1	Digital Input 1
DIGITAL_IN_2	Digital Input 2
DIGITAL_OUT_1	Digital output 1
DIGITAL_OUT_2	Digital output 2

OPC-UA SERVER CERTIFICATE

File that represents the Server Certificate in DER format

OPC-UA SERVER KEY

File that represents the Server key

RESET CERTIFICATE

Reload the default certificate and key

18. DOWNLOADING THE DATALOGGER FILES (MODBUS PROTOCOL MODELS ONLY)

In the "Data logger view" section you can download the entire timed database in csv text format.

In the "Data logger event view" section you can download the entire event database in csv text format.



THE TEXT FILES DOWNLOADED BY THE DATA LOGGER HAVE THE DEFAULT .CGI EXTENSION. TO USE THEM WITH EXCEL-TYPE SOFTWARE IT IS POSSIBLE TO RENAME THEM AS .CSV

19. MODBUS PASSTHROUGH (MODBUS PROTOCOL MODELS ONLY)

Thanks to the Modbus Passthrough function it is possible to extend the amount of I/O available in the device via the RS485 port and the Modbus RTU slave protocol, for example by using the Seneca Z-PC series products. In this mode the RS485 port stops working as Modbus RTU slave and the device becomes a Modbus TCP-IP gateway to Modbus RTU serial:

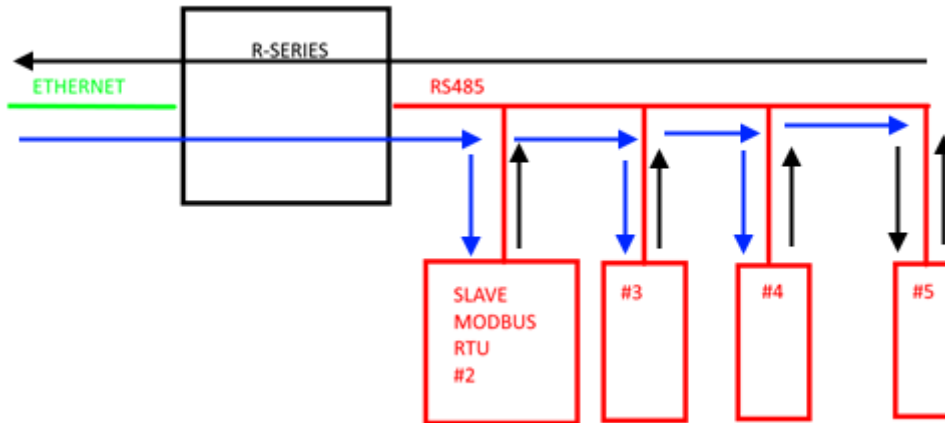

Each Modbus TCP-IP request with station address other than that of the R series device is converted into a serial packet on the RS485 and, in the case of a reply, it is turned over to TCP-IP. Therefore, it is no longer necessary to purchase gateways to extend the I/O number or to connect already available Modbus RTU I/O.

20. **FIRMWARE UPDATE**

In the “Update” section of the Webserver it is possible to update the firmware using a binary file that can be downloaded directly from the Seneca website in the download section of the device.

ATTENTION!

BEFORE UPDATING THE FW, STOP COMMUNICATION WITH THE PLC CONNECTED TO THE DEVICE (FOR EXAMPLE BY DISCONNECTING THE ETHERNET CABLE) OTHERWISE THE COMMUNICATION WITH THE PLC WILL PREVENT THE CORRECT SENDING OF THE FIRMWARE AND THE PROCEDURE WILL NOT BE SUCCESSFUL.

21. **RESETTING THE DEVICE TO ITS FACTORY CONFIGURATION**

The factory configuration resets all parameters to default.

To reset the device to the factory configuration it is necessary to follow the procedure below:

- 1) Remove power from the device
- 2) Turn dip switches 1 and 2 to ON
- 3) Power up the device and wait at least 10 seconds
- 4) Turn dip switches 1 and 2 to OFF
- 5) At the next restart the device will have loaded the factory configuration

ATTENTION!

RESTORING TO FACTORY DEFAULT DELETES ANY ACQUIRED LOGS AND ALL CONFIGURATIONS. BE SURE TO SAVE THE CURRENT CONFIGURATION AND LOG FILE BEFORE PERFORMING THIS OPERATION.

22. MODBUS COMMUNICATION PROTOCOL (MODBUS PROTOCOL MODELS ONLY)

The supported communication protocol is:

- Modbus RTU Slave (from the RS485 port)
- Modbus TCP-IP Server (from Ethernet ports)

The Modbus TCP-IP Server supports up to 8 concurrent clients.

For more information on these protocols, see the website:

<http://www.modbus.org/specs.php>.

22.1. SUPPORTED MODBUS FUNCTION CODES

The following Modbus functions are supported:

- Read Holding Register (function 3)
- Write Single Register (function 6)
- Write Multiple registers (function 16)

 **ATTENTION!**

All 32-bit values are contained in 2 consecutive registers

 **ATTENTION!**

All 64-bit values are contained in 4 consecutive registers

 **ATTENTION!**

Any registers with RW* (in flash memory) can be written up to about 10000 times
The PLC/Master Modbus programmer must not exceed this limit

22.2. MODBUS REGISTER TABLE

The following abbreviations are used in the register tables:

MS = More significant
LS = Less significant
MSW = Most significant word (16bit)
LSW = Least significant word (16bit)
MMSW = Most "most" significant word (16bit)
LLSW = Least "least" significant word (16bit)
MSW = 8 most significant bits
LSB = 8 least significant bits
MSBIT = Most significant bit
MSBIT = Least significant bit
RO = Register in read-only
RW = Read/write register
RW** = Reading and writing register contained in flash memory, writable a maximum of 10000 times.
Unsigned 16 bit = unsigned integer register, can take values from 0 to 65535
Signed 16 bit = signed integer register can take values from -32768 to +32767
Float 32 bits = 32-bit single-precision floating point register (IEEE 754) https://en.wikipedia.org/wiki/IEEE_754
BIT = Boolean registry, can be 0 (false) or 1 (true)

22.3. NUMBERING OF "0-BASED" OR "1-BASED" MODBUS ADDRESSES

According to the Modbus standard the Holding Register registers are addressable from 0 to 65535, there are 2 different conventions for numbering the addresses: "0-BASED" and "1-BASED".

For greater clarity, Seneca shows its register tables in both conventions.

ATTENTION!

CAREFULLY READ THE DOCUMENTATION OF THE MODBUS MASTER DEVICE IN ORDER TO UNDERSTAND WHICH OF THE TWO CONVENTIONS THE MANUFACTURER HAS DECIDED TO USE

22.4. NUMBERING OF MODBUS ADDRESSES WITH "0-BASED" CONVENTION

The numbering is:

HOLDING REGISTER MODBUS ADDRESS (OFFSET)	MEANING
0	FIRST REGISTER
1	SECOND REGISTER
2	THIRD REGISTER
3	FOURTH REGISTER
4	FIFTH REGISTER

Therefore, the first register is at address 0.

In the following tables, this convention is indicated with "**ADDRESS OFFSET**".

22.5. NUMBERING OF MODBUS ADDRESSES WITH "1 BASED" CONVENTION (STANDARD)

The numbering is that established by the Modbus consortium and is of the type:

HOLDING REGISTER MODBUS ADDRESS 4x	MEANING
40001	FIRST REGISTER
40002	SECOND REGISTER
40003	THIRD REGISTER
40004	FOURTH REGISTER
40005	FIFTH REGISTER

In the following tables this convention is indicated with "**ADDRESS 4x**" since a 4 is added to the address so that the first Modbus register is 40001.

A further convention is also possible where the number 4 is omitted in front of the register address:

HOLDING MODBUS ADDRESS WITHOUT 4x	MEANING
1	FIRST REGISTER
2	SECOND REGISTER
3	THIRD REGISTER
4	FOURTH REGISTER
5	FIFTH REGISTER

22.6. BIT CONVENTION WITHIN A MODBUS HOLDING REGISTER

A Modbus Holding Register consists of 16 bits with the following convention:

BIT 15	BIT 14	BIT 13	BIT 12	BIT 11	BIT 10	BIT 9	BIT 8	BIT 7	BIT 6	BIT 5	BIT 4	BIT 3	BIT 2	BIT 1	BIT 0
-----------	-----------	-----------	-----------	-----------	-----------	----------	----------	----------	----------	----------	----------	----------	----------	----------	----------

For instance, if the value of the register in decimal is

12300

the value 12300 in hexadecimal is:

0x300C

the hexadecimal 0x300C in binary value is:

11 0000 0000 1100

So, using the above convention, we get:

BIT 15	BIT 14	BIT 13	BIT 12	BIT 11	BIT 10	BIT 9	BIT 8	BIT 7	BIT 6	BIT 5	BIT 4	BIT 3	BIT 2	BIT 1	BIT 0
0	0	1	1	0	0	0	0	0	0	0	0	1	1	0	0

22.7. MSB and LSB BYTE CONVENTION WITHIN A MODBUS HOLDING REGISTER

A Modbus Holding Register consists of 16 bits with the following convention:

BIT 15	BIT 14	BIT 13	BIT 12	BIT 11	BIT 10	BIT 9	BIT 8	BIT 7	BIT 6	BIT 5	BIT 4	BIT 3	BIT 2	BIT 1	BIT 0
-----------	-----------	-----------	-----------	-----------	-----------	----------	----------	----------	----------	----------	----------	----------	----------	----------	----------

LSB Byte (Least Significant Byte) defines the 8 bits ranging from Bit 0 to Bit 7 included, we define MSB Byte (Most Significant Byte) the 8 bits ranging from Bit 8 to Bit 15 inclusive:

BIT 15	BIT 14	BIT 13	BIT 12	BIT 11	BIT 10	BIT 9	BIT 8	BIT 7	BIT 6	BIT 5	BIT 4	BIT 3	BIT 2	BIT 1	BIT 0
BYTE MSB								BYTE LSB							

22.8. REPRESENTATION OF A 32-BIT VALUE IN TWO CONSECUTIVE MODBUS HOLDING REGISTERS

The representation of a 32-bit value in the Modbus Holding Registers is made using 2 consecutive Holding Registers (a Holding Register is a 16-bit register). To obtain the 32-bit value it is therefore necessary to read two consecutive registers:

For example, if register 40064 contains the 16 most significant bits (MSW) while register 40065 contains the least significant 16 bits (LSW), the 32-bit value is obtained by composing the 2 registers:

BIT	BIT	BIT	BIT	BIT	BIT	BIT	BIT	BIT	BIT	BIT	BIT	BIT	BIT	BIT	BIT
15	14	13	12	11	10	9	8	7	6	5	4	3	2	1	0
40064 MOST SIGNIFICANT WORD															

BIT	BIT	BIT	BIT	BIT	BIT	BIT	BIT	BIT	BIT	BIT	BIT	BIT	BIT	BIT	BIT
15	14	13	12	11	10	9	8	7	6	5	4	3	2	1	0
40065 LEAST SIGNIFICANT WORD															

$$Value_{32bit} = Register_{LSW} + (Register_{MSW} * 65536)$$

In the reading registers it is possible to swap the most significant word with the least significant word, therefore it is possible to obtain 40064 as LSW and 40065 as MSW.

22.9. TYPE OF 32-BIT FLOATING POINT DATA (IEEE 754)

The IEEE 754 standard (https://en.wikipedia.org/wiki/IEEE_754) defines the format for representing floating point numbers.

As already mentioned, since it is a 32-bit data type, its representation occupies two 16-bit holding registers.

To obtain a binary / hexadecimal conversion of a floating point value it is possible to refer to an online converter at this address:

<http://www.h-schmidt.net/FloatConverter/IEEE754.html>

IEEE 754 Converter (JavaScript), V0.22

	Sign	Exponent	Mantissa
Value:	+1	2 ¹	1.2699999809265137
Encoded as:	0	128	2264924
Binary:	<input type="checkbox"/>	<input checked="" type="checkbox"/> <input type="checkbox"/> <input type="checkbox"/> <input type="checkbox"/> <input type="checkbox"/> <input type="checkbox"/> <input type="checkbox"/> <input type="checkbox"/> <input type="checkbox"/> <input type="checkbox"/> <input type="checkbox"/> <input type="checkbox"/> <input type="checkbox"/> <input type="checkbox"/> <input type="checkbox"/> <input type="checkbox"/> <input type="checkbox"/>	<input checked="" type="checkbox"/> <input checked="" type="checkbox"/> <input checked="" type="checkbox"/> <input checked="" type="checkbox"/> <input checked="" type="checkbox"/> <input checked="" type="checkbox"/> <input checked="" type="checkbox"/> <input checked="" type="checkbox"/> <input checked="" type="checkbox"/> <input checked="" type="checkbox"/> <input checked="" type="checkbox"/> <input checked="" type="checkbox"/> <input checked="" type="checkbox"/> <input checked="" type="checkbox"/> <input checked="" type="checkbox"/> <input checked="" type="checkbox"/>

You entered

Value actually stored in float: +1

Error due to conversion: -1

Binary Representation

Hexadecimal Representation

Using the last representation the value 2.54 is represented at 32 bits as:

0x40228F5C

Since we have 16-bit registers available, the value must be divided into MSW and LSW:

0x4022 (16418 decimal) are the 16 most significant bits (MSW) while 0x8F5C (36700 decimal) are the 16 least significant bits (LSW).

22.10. MODBUS 4X HOLDING REGISTERS TABLE (FUNCTION CODE 3)

ADDRESS (4x)	ADDRESS OFFSET	REGISTER	PHASE	DESCRIPTION	W/R	TYPE
40001	0	MACHINE-ID	-	Device ID	RO	UNSIGNED 16BIT
40002	1	FW REVISION (Maior/Minor)	-	FW revision	RO	UNSIGNED 16BIT
40003	2	FW REVISION (Fix/Build)	-	FW revision	RO	UNSIGNED 16BIT
40004	3	FW CODE	-	FW code	RO	UNSIGNED 16BIT
40005	4	FW RESERVED	-	-	RO	UNSIGNED 16BIT
40006	5	FW RESERVED	-	-	RO	UNSIGNED 16BIT
40007	6	BOARD-ID	-	HW revision	RO	UNSIGNED 16BIT
40008	7	BOOT REVISION (Maior/Minor)	-	FW Bootloader revision	RO	UNSIGNED 16BIT
40009	8	BOOT REVISION (Fix/Build)	-	FW Bootloader revision	RO	UNSIGNED 16BIT
40010	9	BOOT CODE	-	Bootloader FW code	RO	UNSIGNED 16BIT
40011	10	RESERVED	-	-	RO	UNSIGNED 16BIT
40012	11	RESERVED	-	-	RO	UNSIGNED 16BIT
40013	12	COMMAND AUX 3H	-	COMMAND REGISTER 3	RW	UNSIGNED 16BIT
40014	13	COMMAND AUX 3L	-		RW	UNSIGNED 16BIT
40015	14	COMMAND AUX 2	-	COMMAND REGISTER 2	RW	UNSIGNED 16BIT
40016	15	COMMAND AUX 1	-		RW	UNSIGNED 16BIT
40017	16	COMMAND	-	Supported command list: 260 decimal to reset MIN/MAX 259 decimal to reset AVG	RW	UNSIGNED 16BIT

ADDRESS (4x)	ADDRESS OFFSET	REGISTER	PHASE	DESCRIPTION	W/R	TYPE
				261 decimal to reset Energy Counters 40986 decimal to load value in CMD_AUX register to COUNTER1 41002 decimal to load value in CMD_AUX register to COUNTER2		
40018	17	STATUS	-	BIT0 -> Cyclic phase sense error (1 ERR, 0 OK) BIT1 -> ALARM (1 ACTIVE, 0 NOT ACTIVE) BIT2 -> DOUT1 status (1 ACTIVE, 0 NOT ACTIVE) BIT3 -> DOUT2 status (1 ACTIVE, 0 NOT ACTIVE) BIT4 -> DIN1 STATUS (1 high, 0 low) BIT5 -> DIN2 STATUS (1 high, 0 low) BIT6 -> Current Cutoff (1 active, 0 inactive) BIT 7 -> Current error L1 (1 CT connected reverse, 0 CT connected OK) BIT 8 -> Current error L2 (1 CT connected reverse, 0 CT connected OK) BIT 9 -> Current error L3 (1 CT connected inverted, 0 CT connected OK) BIT 10 -> Line 1 Voltage/Current	RW	UNSIGNED 16BIT

ADDRESS (4x)	ADDRESS OFFSET	REGISTER	PHASE	DESCRIPTION	W/R	TYPE
				connection error (1 Error, 0 OK) BIT 11 -> Connection error Line 2 Voltage/Current (1 Error, 0 OK) BIT 12 -> Connection error Line 3 Voltage/Current (1 Error, 0 OK)		
40019	18	RESERVED	-	-	RW	UNSIGNED 16BIT
40020	19	RESERVED	-	-	RW	UNSIGNED 16BIT
40021	20	RESERVED	-	-	RW	UNSIGNED 16BIT
40022	21	INPUT VALUES	-	Status of digital inputs 1 and 2 Bit[0] = INPUT1 Bit[1] = INPUT2	RW	UNSIGNED 16BIT
40023	22	Output	-	Status of digital outputs Bit[0] = OUTPUT1 Bit[1] = OUTPUT2	RW	UNSIGNED 16BIT
40024	23	RESERVED	-	-	RW	UNSIGNED 16BIT
40025	24	RESERVED	-	-	RW	UNSIGNED 16BIT
40026	25	RESERVED	-	-	RW	UNSIGNED 16BIT
40027	26	ANALOG OUTPUT MANUAL	-	When the analogue output is in pilot "manual" mode the output 0=0% 8190=100%	RW	UNSIGNED 16BIT
40101	100	V TRUE RMS [V] MSW	L1-L2	TRUE RMS phase-to-phase voltage measurement in [V] (Set to 0 if Aron insertion is used)	RO	FLOAT32
40102	101	V TRUE RMS [V] LSW			RO	
40103	102	V TRUE RMS [V] MSW	L2-L3	TRUE RMS phase-to-phase voltage measurement in [V]	RO	FLOAT32
40104	103	V TRUE RMS [V] LSW			RO	

ADDRESS (4x)	ADDRESS OFFSET	REGISTER	PHASE	DESCRIPTION	W/R	TYPE
				(Set to 0 if Aron insertion is used)		
40105	104	V TRUE RMS [V] MSW	L3-L1	TRUE RMS phase-to-phase voltage measurement in [V] (Set to 0 if Aron insertion is used)	RO	FLOAT32
40106	105	V TRUE RMS [V] LSW			RO	
40107	106	I TRUE RMS [A] MSW	L1	TRUE RMS current measurement in [A]	RO	FLOAT32
40108	107	I TRUE RMS [A] LSW			RO	
40109	108	I TRUE RMS [A] MSW	L2	TRUE RMS current measurement in [A]	RO	FLOAT32
40110	109	I TRUE RMS [A] LSW			RO	
40111	110	I TRUE RMS [A] MSW	L3	TRUE RMS current measurement in [A]	RO	FLOAT32
40112	111	I TRUE RMS [A] LSW			RO	
40113	112	I TRUE RMS [A] MSW	N	TRUE RMS current measurement in [A]	RO	FLOAT32
40114	113	I TRUE RMS [A] LSW			RO	
40115	114	V-I PHASE [°] MSW	L1	Measurement of the angle in [°] between Voltage and Current	RO	FLOAT32
40116	115	V-I PHASE [°] LSW			RO	
40117	116	V-I PHASE [°] MSW	L2	Measurement of the angle in [°] between Voltage and Current	RO	FLOAT32
40118	117	V-I PHASE [°] LSW			RO	
40119	118	V-I PHASE [°] MSW	L3	Measurement of the angle in [°] between Voltage and Current	RO	FLOAT32
40120	119	V-I PHASE [°] LSW			RO	
40121	120	P ACTIVE POWER [W] MSW	L1	Phase Active Power measurement in [W] "+" sign = Absorbed Active Power "- " sign = Generated Active Power	RO	FLOAT32
40122	121	P ACTIVE POWER [W] LSW			RO	
40123	122	P ACTIVE POWER [W] MSW	L2	Phase Active Power measurement in [W] "+" sign = Absorbed Active	RO	FLOAT32
40124	123	P ACTIVE POWER [W] LSW			RO	

ADDRESS (4x)	ADDRESS OFFSET	REGISTER	PHASE	DESCRIPTION	W/R	TYPE
				Power "- sign = Generated Active Power		
40125	124	P ACTIVE POWER [W] MSW	L3	Phase Active Power measurement in [W] "+ sign = Absorbed Active Power "- sign = Generated Active Power	RO	FLOAT32
40126	125	P ACTIVE POWER [W] LSW		RO		
40127	126	Q REACTIVE POWER [VAR] MSW	L1	Phase Reactive Power measurement in [VAR]	RO	FLOAT32
40128	127	Q REACTIVE POWER [VAR] LSW			RO	
40129	128	Q REACTIVE POWER [VAR] MSW	L2	Phase Reactive Power measurement in [VAR]	RO	FLOAT32
40130	129	Q REACTIVE POWER [VAR] LSW			RO	
40131	130	Q REACTIVE POWER [VAR] MSW	L3	Phase Reactive Power measurement in [VAR]	RO	FLOAT32
40132	131	Q REACTIVE POWER [VAR] LSW			RO	
40133	132	S APPARENT POWER [VA] MSW	L1	Phase Apparent Power measurement in [VA]	RO	FLOAT32
40134	133	S APPARENT POWER [VA] LSW			RO	
40135	134	S APPARENT POWER [VA] MSW	L2	Phase Apparent Power measurement in [VA]	RO	FLOAT32
40136	135	S APPARENT POWER [VA] LSW			RO	
40137	136	S APPARENT POWER [VA] MSW	L3	Phase Apparent Power measurement in [VA]	RO	FLOAT32
40138	137	S APPARENT POWER [VA] LSW			RO	
40139	138	PF POWER FACTOR MSW	L1	Phase power factor measurement "+ sign = User "- sign = Generator	RO	FLOAT32
40140	139	PF POWER FACTOR LSW			RO	
40141	140	PF POWER FACTOR MSW	L2		RO	FLOAT32

ADDRESS (4x)	ADDRESS OFFSET	REGISTER	PHASE	DESCRIPTION	W/R	TYPE
40142	141	PF POWER FACTOR LSW		Phase power factor measurement "+" sign = User "- " sign = Generator	RO	
40143	142	PF POWER FACTOR MSW	L3	Phase power factor measurement "+" sign = User "- " sign = Generator	RO	FLOAT32
40144	143	PF POWER FACTOR LSW			RO	
40145	144	F FREQUENCY [HZ] MSW	L1	Phase frequency measurement in [Hz]	RO	FLOAT32
40146	145	F FREQUENCY [HZ] LSW			RO	
40147	146	F FREQUENCY [HZ] MSW	L2	Phase frequency measurement in [Hz]	RO	FLOAT32
40148	147	F FREQUENCY [HZ] LSW			RO	
40149	148	F FREQUENCY [HZ] MSW	L3	Phase frequency measurement in [Hz]	RO	FLOAT32
40150	149	F FREQUENCY [HZ] LSW			RO	
40151	150	PERIOD [s] MSW	L1	Phase period measurement in [s]	RO	FLOAT32
40152	151	PERIOD [s] LSW			RO	
40153	152	PERIOD [s] MSW	L2	Phase period measurement in [s]	RO	FLOAT32
40154	153	PERIOD [s] LSW			RO	
40155	154	PERIOD [s] MSW	L3	Phase period measurement in [s]	RO	FLOAT32
40156	155	PERIOD [s] LSW			RO	
40157	156	V-V PHASE [°] MSW	L1-L2	Measurement of the angle in [°] between Voltage and Voltage	RO	FLOAT32
40158	157	V-V PHASE [°] LSW			RO	
40159	158	V-V PHASE [°] MSW	L2-L3	Measurement of the angle in [°] between Voltage and Voltage	RO	FLOAT32
40160	159	V-V PHASE [°] LSW			RO	
40161	160	V-V PHASE [°] MSW	L3-L1	Measurement of the angle in [°] between Voltage and Voltage	RO	FLOAT32
40162	161	V-V PHASE [°] LSW			RO	
40163	162	VLN TRUE RMS [V] MSW	L1-N	Phase-neutral star voltage measurement (if Aron insertion is used, VL1N = V12)	RO	FLOAT32
40164	163	VLN TRUE RMS [V] LSW			RO	

ADDRESS (4x)	ADDRESS OFFSET	REGISTER	PHASE	DESCRIPTION	W/R	TYPE
40165	164	VLN TRUE RMS [V] MSW	L2-N	Phase-neutral star voltage measurement (if Aron insertion is used, VL2N = VL1N = V12)	RO	FLOAT32
40166	165	VLN TRUE RMS [V] LSW			RO	
40167	166	VLN TRUE RMS [V] MSW	L3-N	Phase-neutral star voltage measurement (if Aron insertion is used, VL3N = V32)	RO	FLOAT32
40168	167	VLN TRUE RMS [V] LSW			RO	
40169	168	P TOTAL [W] MSW	3PH	Total Active Power measurement in [W] "+" sign = Absorbed Active Power "- " sign = Generated Active Power	RO	FLOAT32
40170	169	P TOTAL [W] LSW			RO	
40171	170	Q TOTAL [VAR] MSW	3PH	Total Reactive Power measurement in [VAR]	RO	FLOAT32
40172	171	Q TOTAL [VAR] LSW			RO	
40173	172	S TOTAL [VA] MSW	3PH	Total Apparent Power measurement in [VA]	RO	FLOAT32
40174	173	S TOTAL [VA] LSW			RO	
40175	174	PF TOTAL MSW	3PH	Total power factor measurement "+" sign = User "- " sign = Generator	RO	FLOAT32
40176	175	PF TOTAL LSW			RO	
40177	176	THD V [%] MSW	L1	Measurement of the total voltage harmonic distortion in [%] in comparison with the fundamental	RO	FLOAT32
40178	177	THD V [%] LSW			RO	
40179	178	THD V [%] MSW	L2	Measurement of the total voltage harmonic distortion in [%] in comparison with the fundamental	RO	FLOAT32
40180	179	THD V [%] LSW			RO	

ADDRESS (4x)	ADDRESS OFFSET	REGISTER	PHASE	DESCRIPTION	W/R	TYPE
40181	180	THD V [%] MSW	L3	Measurement of the total voltage harmonic	RO	FLOAT32
40182	181	THD V [%] LSW		distortion in [%] in comparison with the fundamental	RO	
40183	182	THD I [%] MSW	L1	Measurement of the total current harmonic	RO	FLOAT32
40184	183	THD I [%] LSW		distortion in [%] in comparison with the fundamental	RO	
40185	184	THD I [%] MSW	L2	Measurement of the total current harmonic	RO	FLOAT32
40186	185	THD I [%] LSW		distortion in [%] in comparison with the fundamental	RO	
40187	186	THD I [%] MSW	L3	Measurement of the total current harmonic	RO	FLOAT32
40188	187	THD I [%] LSW		distortion in [%] in comparison with the fundamental	RO	
40189	188	VTRUE RMS FUNDAMENTAL [V] MSW	L1-N	Measurement of the Phase - Neutral VTRUE RMS of the fundamental alone [V]	RO	FLOAT32
40190	189	VTRUE RMS FUNDAMENTAL [V] LSW			RO	
40191	190	VTRUE RMS FUNDAMENTAL [V] MSW	L2-N	Measurement of the Phase - Neutral VTRUE RMS of the fundamental alone [V]	RO	FLOAT32
40192	191	VTRUE RMS FUNDAMENTAL [V] LSW			RO	
40193	192	VTRUE RMS FUNDAMENTAL [V] MSW	L3-N	Measurement of the Phase - Neutral VTRUE RMS of the fundamental alone [V]	RO	FLOAT32
40194	193	VTRUE RMS FUNDAMENTAL [V] LSW			RO	
40195	194	VTRUE RMS HARMONIC 2 [V] MSW	L1-N	Measurement of the Phase - Neutral VTRUE RMS of the i-th harmonic [V]	RO	FLOAT32
40196	195	VTRUE RMS HARMONIC 2 [V] LSW			RO	
40197	196	VTRUE RMS HARMONIC 2 [V] MSW	L2-N	Measurement of the Phase - Neutral VTRUE RMS of the i-th harmonic [V]	RO	FLOAT32
40198	197	VTRUE RMS HARMONIC 2 [V] LSW			RO	

ADDRESS (4x)	ADDRESS OFFSET	REGISTER	PHASE	DESCRIPTION	W/R	TYPE
40199	198	VTRUE RMS HARMONIC 2 [V] MSW	L3-N	Measurement of the Phase - Neutral VTRUE RMS of the i-th harmonic [V]	RO	FLOAT32
40200	199	VTRUE RMS HARMONIC 2 [V] LSW			RO	
40201	200	VTRUE RMS HARMONIC 3 [V] MSW	L1-N	Measurement of the Phase - Neutral VTRUE RMS of the i-th harmonic [V]	RO	FLOAT32
40202	201	VTRUE RMS HARMONIC 3 [V] LSW			RO	
40203	202	VTRUE RMS HARMONIC 3 [V] MSW	L2-N	Measurement of the Phase - Neutral VTRUE RMS of the i-th harmonic [V]	RO	FLOAT32
40204	203	VTRUE RMS HARMONIC 3 [V] LSW			RO	
40205	204	VTRUE RMS HARMONIC 3 [V] MSW	L3-N	Measurement of the Phase - Neutral VTRUE RMS of the i-th harmonic [V]	RO	FLOAT32
40206	205	VTRUE RMS HARMONIC 3 [V] LSW			RO	
40207	206	VTRUE RMS HARMONIC 4 [V] MSW	L1-N	Measurement of the Phase - Neutral VTRUE RMS of the i-th harmonic [V]	RO	FLOAT32
40208	207	VTRUE RMS HARMONIC 4 [V] LSW			RO	
40209	208	VTRUE RMS HARMONIC 4 [V] MSW	L2-N	Measurement of the Phase - Neutral VTRUE RMS of the i-th harmonic [V]	RO	FLOAT32
40210	209	VTRUE RMS HARMONIC 4 [V] LSW			RO	
40211	210	VTRUE RMS HARMONIC 4 [V] MSW	L3-N	Measurement of the Phase - Neutral VTRUE RMS of the i-th harmonic [V]	RO	FLOAT32
40212	211	VTRUE RMS HARMONIC 4 [V] LSW			RO	
40213	212	VTRUE RMS HARMONIC 5 [V] MSW	L1-N	Measurement of the Phase - Neutral VTRUE RMS of the i-th harmonic [V]	RO	FLOAT32
40214	213	VTRUE RMS HARMONIC 5 [V] LSW			RO	
40215	214	VTRUE RMS HARMONIC 5 [V] MSW	L2-N	Measurement of the Phase - Neutral VTRUE RMS of the i-th harmonic [V]	RO	FLOAT32
40216	215	VTRUE RMS HARMONIC 5 [V] LSW			RO	
40217	216	VTRUE RMS HARMONIC 5 [V] MSW	L3-N	Measurement of the Phase - Neutral VTRUE RMS of the i-th harmonic [V]	RO	FLOAT32
40218	217	VTRUE RMS HARMONIC 5 [V] LSW			RO	
40219	218	VTRUE RMS HARMONIC 6 [V] MSW	L1-N	Measurement of the Phase - Neutral VTRUE RMS of the i-th harmonic [V]	RO	FLOAT32
40220	219	VTRUE RMS HARMONIC 6 [V] LSW			RO	
40221	220	VTRUE RMS HARMONIC 6 [V] MSW	L2-N	Measurement of the Phase - Neutral VTRUE RMS of the i-th harmonic [V]	RO	FLOAT32
40222	221	VTRUE RMS HARMONIC 6 [V] LSW			RO	
40223	222	VTRUE RMS HARMONIC 6 [V] MSW	L3-N	Measurement of the Phase - Neutral	RO	FLOAT32
40224	223	VTRUE RMS HARMONIC 6 [V] LSW			RO	

ADDRESS (4x)	ADDRESS OFFSET	REGISTER	PHASE	DESCRIPTION	W/R	TYPE
				VTRUE RMS of the i-th harmonic [V]		
40225	224	VTRUE RMS HARMONIC 7 [V] MSW	L1-N	Measurement of the Phase - Neutral VTRUE RMS of the i-th harmonic [V]	RO	FLOAT32
40226	225	VTRUE RMS HARMONIC 7 [V] LSW			RO	
40227	226	VTRUE RMS HARMONIC 7 [V] MSW	L2-N	Measurement of the Phase - Neutral VTRUE RMS of the i-th harmonic [V]	RO	FLOAT32
40228	227	VTRUE RMS HARMONIC 7 [V] LSW			RO	
40229	228	VTRUE RMS HARMONIC 7 [V] MSW	L3-N	Measurement of the Phase - Neutral VTRUE RMS of the i-th harmonic [V]	RO	FLOAT32
40230	229	VTRUE RMS HARMONIC 7 [V] LSW			RO	
40231	230	VTRUE RMS HARMONIC 8 [V] MSW	L1-N	Measurement of the Phase - Neutral VTRUE RMS of the i-th harmonic [V]	RO	FLOAT32
40232	231	VTRUE RMS HARMONIC 8 [V] LSW			RO	
40233	232	VTRUE RMS HARMONIC 8 [V] MSW	L2-N	Measurement of the Phase - Neutral VTRUE RMS of the i-th harmonic [V]	RO	FLOAT32
40234	233	VTRUE RMS HARMONIC 8 [V] LSW			RO	
40235	234	VTRUE RMS HARMONIC 8 [V] MSW	L3-N	Measurement of the Phase - Neutral VTRUE RMS of the i-th harmonic [V]	RO	FLOAT32
40236	235	VTRUE RMS HARMONIC 8 [V] LSW			RO	
40237	236	VTRUE RMS HARMONIC 9 [V] MSW	L1-N	Measurement of the Phase - Neutral VTRUE RMS of the i-th harmonic [V]	RO	FLOAT32
40238	237	VTRUE RMS HARMONIC 9 [V] LSW			RO	
40239	238	VTRUE RMS HARMONIC 9 [V] MSW	L2-N	Measurement of the Phase - Neutral VTRUE RMS of the i-th harmonic [V]	RO	FLOAT32
40240	239	VTRUE RMS HARMONIC 9 [V] LSW			RO	
40241	240	VTRUE RMS HARMONIC 9 [V] MSW	L3-N	Measurement of the Phase - Neutral VTRUE RMS of the i-th harmonic [V]	RO	FLOAT32
40242	241	VTRUE RMS HARMONIC 9 [V] LSW			RO	
40243	242	VTRUE RMS HARMONIC 10 [V] MSW	L1-N	Measurement of the Phase - Neutral VTRUE RMS of the i-th harmonic [V]	RO	FLOAT32
40244	243	VTRUE RMS HARMONIC 10 [V] LSW			RO	
40245	244	VTRUE RMS HARMONIC 10 [V] MSW	L2-N	Measurement of the Phase - Neutral VTRUE RMS of the i-th harmonic [V]	RO	FLOAT32
40246	245	VTRUE RMS HARMONIC 10 [V] LSW			RO	
40247	246	VTRUE RMS HARMONIC 10 [V] MSW	L3-N	Measurement of the Phase - Neutral VTRUE RMS of the i-th harmonic [V]	RO	FLOAT32
40248	247	VTRUE RMS HARMONIC 10 [V] LSW			RO	

ADDRESS (4x)	ADDRESS OFFSET	REGISTER	PHASE	DESCRIPTION	W/R	TYPE
40249	248	VTRUE RMS HARMONIC 11 [V] MSW	L1-N	Measurement of the Phase - Neutral VTRUE RMS of the i-th harmonic [V]	RO	FLOAT32
40250	249	VTRUE RMS HARMONIC 11 [V] LSW			RO	
40251	250	VTRUE RMS HARMONIC 11 [V] MSW	L2-N	Measurement of the Phase - Neutral VTRUE RMS of the i-th harmonic [V]	RO	FLOAT32
40252	251	VTRUE RMS HARMONIC 11 [V] LSW			RO	
40253	252	VTRUE RMS HARMONIC 11 [V] MSW	L3-N	Measurement of the Phase - Neutral VTRUE RMS of the i-th harmonic [V]	RO	FLOAT32
40254	253	VTRUE RMS HARMONIC 11 [V] LSW			RO	
40255	254	VTRUE RMS HARMONIC 12 [V] MSW	L1-N	Measurement of the Phase - Neutral VTRUE RMS of the i-th harmonic [V]	RO	FLOAT32
40256	255	VTRUE RMS HARMONIC 12 [V] LSW			RO	
40257	256	VTRUE RMS HARMONIC 12 [V] MSW	L2-N	Measurement of the Phase - Neutral VTRUE RMS of the i-th harmonic [V]	RO	FLOAT32
40258	257	VTRUE RMS HARMONIC 12 [V] LSW			RO	
40259	258	VTRUE RMS HARMONIC 12 [V] MSW	L3-N	Measurement of the Phase - Neutral VTRUE RMS of the i-th harmonic [V]	RO	FLOAT32
40260	259	VTRUE RMS HARMONIC 12 [V] LSW			RO	
40261	260	VTRUE RMS HARMONIC 13 [V] MSW	L1-N	Measurement of the Phase - Neutral VTRUE RMS of the i-th harmonic [V]	RO	FLOAT32
40262	261	VTRUE RMS HARMONIC 13 [V] LSW			RO	
40263	262	VTRUE RMS HARMONIC 13 [V] MSW	L2-N	Measurement of the Phase - Neutral VTRUE RMS of the i-th harmonic [V]	RO	FLOAT32
40264	263	VTRUE RMS HARMONIC 13 [V] LSW			RO	
40265	264	VTRUE RMS HARMONIC 13 [V] MSW	L3-N	Measurement of the Phase - Neutral VTRUE RMS of the i-th harmonic [V]	RO	FLOAT32
40266	265	VTRUE RMS HARMONIC 13 [V] LSW			RO	
40267	266	VTRUE RMS HARMONIC 14 [V] MSW	L1-N	Measurement of the Phase - Neutral VTRUE RMS of the i-th harmonic [V]	RO	FLOAT32
40268	267	VTRUE RMS HARMONIC 14 [V] LSW			RO	
40269	268	VTRUE RMS HARMONIC 14 [V] MSW	L2-N	Measurement of the Phase - Neutral VTRUE RMS of the i-th harmonic [V]	RO	FLOAT32
40270	269	VTRUE RMS HARMONIC 14 [V] LSW			RO	
40271	270	VTRUE RMS HARMONIC 14 [V] MSW	L3-N	Measurement of the Phase - Neutral VTRUE RMS of the i-th harmonic [V]	RO	FLOAT32
40272	271	VTRUE RMS HARMONIC 14 [V] LSW			RO	
40273	272	VTRUE RMS HARMONIC 15 [V] MSW	L1-N	Measurement of the Phase - Neutral	RO	FLOAT32
40274	273	VTRUE RMS HARMONIC 15 [V] LSW			RO	

ADDRESS (4x)	ADDRESS OFFSET	REGISTER	PHASE	DESCRIPTION	W/R	TYPE
				VTRUE RMS of the i-th harmonic [V]		
40275	274	VTRUE RMS HARMONIC 15 [V] MSW	L2-N	Measurement of the Phase - Neutral VTRUE RMS of the i-th harmonic [V]	RO	FLOAT32
40276	275	VTRUE RMS HARMONIC 15 [V] LSW			RO	
40277	276	VTRUE RMS HARMONIC 15 [V] MSW	L3-N	Measurement of the Phase - Neutral VTRUE RMS of the i-th harmonic [V]	RO	FLOAT32
40278	277	VTRUE RMS HARMONIC 15 [V] LSW			RO	
40279	278	VTRUE RMS HARMONIC 16 [V] MSW	L1-N	Measurement of the Phase - Neutral VTRUE RMS of the i-th harmonic [V]	RO	FLOAT32
40280	279	VTRUE RMS HARMONIC 16 [V] LSW			RO	
40281	280	VTRUE RMS HARMONIC 16 [V] MSW	L2-N	Measurement of the Phase - Neutral VTRUE RMS of the i-th harmonic [V]	RO	FLOAT32
40282	281	VTRUE RMS HARMONIC 16 [V] LSW			RO	
40283	282	VTRUE RMS HARMONIC 16 [V] MSW	L3-N	Measurement of the Phase - Neutral VTRUE RMS of the i-th harmonic [V]	RO	FLOAT32
40284	283	VTRUE RMS HARMONIC 16 [V] LSW			RO	
40285	284	VTRUE RMS HARMONIC 17 [V] MSW	L1-N	Measurement of the Phase - Neutral VTRUE RMS of the i-th harmonic [V]	RO	FLOAT32
40286	285	VTRUE RMS HARMONIC 17 [V] LSW			RO	
40287	286	VTRUE RMS HARMONIC 17 [V] MSW	L2-N	Measurement of the Phase - Neutral VTRUE RMS of the i-th harmonic [V]	RO	FLOAT32
40288	287	VTRUE RMS HARMONIC 17 [V] LSW			RO	
40289	288	VTRUE RMS HARMONIC 17 [V] MSW	L3-N	Measurement of the Phase - Neutral VTRUE RMS of the i-th harmonic [V]	RO	FLOAT32
40290	289	VTRUE RMS HARMONIC 17 [V] LSW			RO	
40291	290	VTRUE RMS HARMONIC 18 [V] MSW	L1-N	Measurement of the Phase - Neutral VTRUE RMS of the i-th harmonic [V]	RO	FLOAT32
40292	291	VTRUE RMS HARMONIC 18 [V] LSW			RO	
40293	292	VTRUE RMS HARMONIC 18 [V] MSW	L2-N	Measurement of the Phase - Neutral VTRUE RMS of the i-th harmonic [V]	RO	FLOAT32
40294	293	VTRUE RMS HARMONIC 18 [V] LSW			RO	
40295	294	VTRUE RMS HARMONIC 18 [V] MSW	L3-N	Measurement of the Phase - Neutral VTRUE RMS of the i-th harmonic [V]	RO	FLOAT32
40296	295	VTRUE RMS HARMONIC 18 [V] LSW			RO	
40297	296	VTRUE RMS HARMONIC 19 [V] MSW	L1-N	Measurement of the Phase - Neutral VTRUE RMS of the i-th harmonic [V]	RO	FLOAT32
40298	297	VTRUE RMS HARMONIC 19 [V] LSW			RO	

ADDRESS (4x)	ADDRESS OFFSET	REGISTER	PHASE	DESCRIPTION	W/R	TYPE
40299	298	VTRUE RMS HARMONIC 19 [V] MSW	L2-N	Measurement of the Phase - Neutral VTRUE RMS of the i-th harmonic [V]	RO	FLOAT32
40300	299	VTRUE RMS HARMONIC 19 [V] LSW			RO	
40301	300	VTRUE RMS HARMONIC 19 [V] MSW	L3-N	Measurement of the Phase - Neutral VTRUE RMS of the i-th harmonic [V]	RO	FLOAT32
40302	301	VTRUE RMS HARMONIC 19 [V] LSW			RO	
40303	302	VTRUE RMS HARMONIC 20 [V] MSW	L1-N	Measurement of the Phase - Neutral VTRUE RMS of the i-th harmonic [V]	RO	FLOAT32
40304	303	VTRUE RMS HARMONIC 20 [V] LSW			RO	
40305	304	VTRUE RMS HARMONIC 20 [V] MSW	L2-N	Measurement of the Phase - Neutral VTRUE RMS of the i-th harmonic [V]	RO	FLOAT32
40306	305	VTRUE RMS HARMONIC 20 [V] LSW			RO	
40307	306	VTRUE RMS HARMONIC 20 [V] MSW	L3-N	Measurement of the Phase - Neutral VTRUE RMS of the i-th harmonic [V]	RO	FLOAT32
40308	307	VTRUE RMS HARMONIC 20 [V] LSW			RO	
40309	308	VTRUE RMS HARMONIC 21 [V] MSW	L1-N	Measurement of the Phase - Neutral VTRUE RMS of the i-th harmonic [V]	RO	FLOAT32
40310	309	VTRUE RMS HARMONIC 21 [V] LSW			RO	
40311	310	VTRUE RMS HARMONIC 21 [V] MSW	L2-N	Measurement of the Phase - Neutral VTRUE RMS of the i-th harmonic [V]	RO	FLOAT32
40312	311	VTRUE RMS HARMONIC 21 [V] LSW			RO	
40313	312	VTRUE RMS HARMONIC 21 [V] MSW	L3-N	Measurement of the Phase - Neutral VTRUE RMS of the i-th harmonic [V]	RO	FLOAT32
40314	313	VTRUE RMS HARMONIC 21 [V] LSW			RO	
40315	314	VTRUE RMS HARMONIC 22 [V] MSW	L1-N	Measurement of the Phase - Neutral VTRUE RMS of the i-th harmonic [V]	RO	FLOAT32
40316	315	VTRUE RMS HARMONIC 22 [V] LSW			RO	
40317	316	VTRUE RMS HARMONIC 22 [V] MSW	L2-N	Measurement of the Phase - Neutral VTRUE RMS of the i-th harmonic [V]	RO	FLOAT32
40318	317	VTRUE RMS HARMONIC 22 [V] LSW			RO	
40319	318	VTRUE RMS HARMONIC 22 [V] MSW	L3-N	Measurement of the Phase - Neutral VTRUE RMS of the i-th harmonic [V]	RO	FLOAT32
40320	319	VTRUE RMS HARMONIC 22 [V] LSW			RO	
40321	320	VTRUE RMS HARMONIC 23 [V] MSW	L1-N	Measurement of the Phase - Neutral VTRUE RMS of the i-th harmonic [V]	RO	FLOAT32
40322	321	VTRUE RMS HARMONIC 23 [V] LSW			RO	
40323	322	VTRUE RMS HARMONIC 23 [V] MSW	L2-N	Measurement of the Phase - Neutral	RO	FLOAT32
40324	323	VTRUE RMS HARMONIC 23 [V] LSW			RO	

ADDRESS (4x)	ADDRESS OFFSET	REGISTER	PHASE	DESCRIPTION	W/R	TYPE
				VTRUE RMS of the i-th harmonic [V]		
40325	324	VTRUE RMS HARMONIC 23 [V] MSW	L3-N	Measurement of the Phase - Neutral VTRUE RMS of the i-th harmonic [V]	RO	FLOAT32
40326	325	VTRUE RMS HARMONIC 23 [V] LSW			RO	
40327	326	VTRUE RMS HARMONIC 24 [V] MSW	L1-N	Measurement of the Phase - Neutral VTRUE RMS of the i-th harmonic [V]	RO	FLOAT32
40328	327	VTRUE RMS HARMONIC 24 [V] LSW			RO	
40329	328	VTRUE RMS HARMONIC 24 [V] MSW	L2-N	Measurement of the Phase - Neutral VTRUE RMS of the i-th harmonic [V]	RO	FLOAT32
40330	329	VTRUE RMS HARMONIC 24 [V] LSW			RO	
40331	330	VTRUE RMS HARMONIC 24 [V] MSW	L3-N	Measurement of the Phase - Neutral VTRUE RMS of the i-th harmonic [V]	RO	FLOAT32
40332	331	VTRUE RMS HARMONIC 24 [V] LSW			RO	
40333	332	VTRUE RMS HARMONIC 25 [V] MSW	L1-N	Measurement of the Phase - Neutral VTRUE RMS of the i-th harmonic [V]	RO	FLOAT32
40334	333	VTRUE RMS HARMONIC 25 [V] LSW			RO	
40335	334	VTRUE RMS HARMONIC 25 [V] MSW	L2-N	Measurement of the Phase - Neutral VTRUE RMS of the i-th harmonic [V]	RO	FLOAT32
40336	335	VTRUE RMS HARMONIC 25 [V] LSW			RO	
40337	336	VTRUE RMS HARMONIC 25 [V] MSW	L3-N	Measurement of the Phase - Neutral VTRUE RMS of the i-th harmonic [V]	RO	FLOAT32
40338	337	VTRUE RMS HARMONIC 25 [V] LSW			RO	
40339	338	VTRUE RMS HARMONIC 26 [V] MSW	L1-N	Measurement of the Phase - Neutral VTRUE RMS of the i-th harmonic [V]	RO	FLOAT32
40340	339	VTRUE RMS HARMONIC 26 [V] LSW			RO	
40341	340	VTRUE RMS HARMONIC 26 [V] MSW	L2-N	Measurement of the Phase - Neutral VTRUE RMS of the i-th harmonic [V]	RO	FLOAT32
40342	341	VTRUE RMS HARMONIC 26 [V] LSW			RO	
40343	342	VTRUE RMS HARMONIC 26 [V] MSW	L3-N	Measurement of the Phase - Neutral VTRUE RMS of the i-th harmonic [V]	RO	FLOAT32
40344	343	VTRUE RMS HARMONIC 26 [V] LSW			RO	
40345	344	VTRUE RMS HARMONIC 27 [V] MSW	L1-N	Measurement of the Phase - Neutral VTRUE RMS of the i-th harmonic [V]	RO	FLOAT32
40346	345	VTRUE RMS HARMONIC 27 [V] LSW			RO	
40347	346	VTRUE RMS HARMONIC 27 [V] MSW	L2-N	Measurement of the Phase - Neutral VTRUE RMS of the i-th harmonic [V]	RO	FLOAT32
40348	347	VTRUE RMS HARMONIC 27 [V] LSW			RO	

ADDRESS (4x)	ADDRESS OFFSET	REGISTER	PHASE	DESCRIPTION	W/R	TYPE
40349	348	VTRUE RMS HARMONIC 27 [V] MSW	L3-N	Measurement of the Phase - Neutral VTRUE RMS of the i-th harmonic [V]	RO	FLOAT32
40350	349	VTRUE RMS HARMONIC 27 [V] LSW			RO	
40351	350	VTRUE RMS HARMONIC 28 [V] MSW	L1-N	Measurement of the Phase - Neutral VTRUE RMS of the i-th harmonic [V]	RO	FLOAT32
40352	351	VTRUE RMS HARMONIC 28 [V] LSW			RO	
40353	352	VTRUE RMS HARMONIC 28 [V] MSW	L2-N	Measurement of the Phase - Neutral VTRUE RMS of the i-th harmonic [V]	RO	FLOAT32
40354	353	VTRUE RMS HARMONIC 28 [V] LSW			RO	
40355	354	VTRUE RMS HARMONIC 28 [V] MSW	L3-N	Measurement of the Phase - Neutral VTRUE RMS of the i-th harmonic [V]	RO	FLOAT32
40356	355	VTRUE RMS HARMONIC 28 [V] LSW			RO	
40357	356	VTRUE RMS HARMONIC 29 [V] MSW	L1-N	Measurement of the Phase - Neutral VTRUE RMS of the i-th harmonic [V]	RO	FLOAT32
40358	357	VTRUE RMS HARMONIC 29 [V] LSW			RO	
40359	358	VTRUE RMS HARMONIC 29 [V] MSW	L2-N	Measurement of the Phase - Neutral VTRUE RMS of the i-th harmonic [V]	RO	FLOAT32
40360	359	VTRUE RMS HARMONIC 29 [V] LSW			RO	
40361	360	VTRUE RMS HARMONIC 29 [V] MSW	L3-N	Measurement of the Phase - Neutral VTRUE RMS of the i-th harmonic [V]	RO	FLOAT32
40362	361	VTRUE RMS HARMONIC 29 [V] LSW			RO	
40363	362	VTRUE RMS HARMONIC 30 [V] MSW	L1-N	Measurement of the Phase - Neutral VTRUE RMS of the i-th harmonic [V]	RO	FLOAT32
40364	363	VTRUE RMS HARMONIC 30 [V] LSW			RO	
40365	364	VTRUE RMS HARMONIC 30 [V] MSW	L2-N	Measurement of the Phase - Neutral VTRUE RMS of the i-th harmonic [V]	RO	FLOAT32
40366	365	VTRUE RMS HARMONIC 30 [V] LSW			RO	
40367	366	VTRUE RMS HARMONIC 30 [V] MSW	L3-N	Measurement of the Phase - Neutral VTRUE RMS of the i-th harmonic [V]	RO	FLOAT32
40368	367	VTRUE RMS HARMONIC 30 [V] LSW			RO	
40369	368	VTRUE RMS HARMONIC 31 [V] MSW	L1-N	Measurement of the Phase - Neutral VTRUE RMS of the i-th harmonic [V]	RO	FLOAT32
40370	369	VTRUE RMS HARMONIC 31 [V] LSW			RO	
40371	370	VTRUE RMS HARMONIC 31 [V] MSW	L2-N	Measurement of the Phase - Neutral VTRUE RMS of the i-th harmonic [V]	RO	FLOAT32
40372	371	VTRUE RMS HARMONIC 31 [V] LSW			RO	
40373	372	VTRUE RMS HARMONIC 31 [V] MSW	L3-N	Measurement of the Phase - Neutral	RO	FLOAT32
40374	373	VTRUE RMS HARMONIC 31 [V] LSW			RO	

ADDRESS (4x)	ADDRESS OFFSET	REGISTER	PHASE	DESCRIPTION	W/R	TYPE
				VTRUE RMS of the i-th harmonic [V]		
40375	374	VTRUE RMS HARMONIC 32 [V] MSW	L1-N	Measurement of the Phase - Neutral VTRUE RMS of the i-th harmonic [V]	RO	FLOAT32
40376	375	VTRUE RMS HARMONIC 32 [V] LSW			RO	
40377	376	VTRUE RMS HARMONIC 32 [V] MSW	L2-N	Measurement of the Phase - Neutral VTRUE RMS of the i-th harmonic [V]	RO	FLOAT32
40378	377	VTRUE RMS HARMONIC 32 [V] LSW			RO	
40379	378	VTRUE RMS HARMONIC 32 [V] MSW	L3-N	Measurement of the Phase - Neutral VTRUE RMS of the i-th harmonic [V]	RO	FLOAT32
40380	379	VTRUE RMS HARMONIC 32 [V] LSW			RO	
40381	380	VTRUE RMS HARMONIC 33 [V] MSW	L1-N	Measurement of the Phase - Neutral VTRUE RMS of the i-th harmonic [V]	RO	FLOAT32
40382	381	VTRUE RMS HARMONIC 33 [V] LSW			RO	
40383	382	VTRUE RMS HARMONIC 33 [V] MSW	L2-N	Measurement of the Phase - Neutral VTRUE RMS of the i-th harmonic [V]	RO	FLOAT32
40384	383	VTRUE RMS HARMONIC 33 [V] LSW			RO	
40385	384	VTRUE RMS HARMONIC 33 [V] MSW	L3-N	Measurement of the Phase - Neutral VTRUE RMS of the i-th harmonic [V]	RO	FLOAT32
40386	385	VTRUE RMS HARMONIC 33 [V] LSW			RO	
40387	386	VTRUE RMS HARMONIC 34 [V] MSW	L1-N	Measurement of the Phase - Neutral VTRUE RMS of the i-th harmonic [V]	RO	FLOAT32
40388	387	VTRUE RMS HARMONIC 34 [V] LSW			RO	
40389	388	VTRUE RMS HARMONIC 34 [V] MSW	L2-N	Measurement of the Phase - Neutral VTRUE RMS of the i-th harmonic [V]	RO	FLOAT32
40390	389	VTRUE RMS HARMONIC 34 [V] LSW			RO	
40391	390	VTRUE RMS HARMONIC 34 [V] MSW	L3-N	Measurement of the Phase - Neutral VTRUE RMS of the i-th harmonic [V]	RO	FLOAT32
40392	391	VTRUE RMS HARMONIC 34 [V] LSW			RO	
40393	392	VTRUE RMS HARMONIC 35 [V] MSW	L1-N	Measurement of the Phase - Neutral VTRUE RMS of the i-th harmonic [V]	RO	FLOAT32
40394	393	VTRUE RMS HARMONIC 35 [V] LSW			RO	
40395	394	VTRUE RMS HARMONIC 35 [V] MSW	L2-N	Measurement of the Phase - Neutral VTRUE RMS of the i-th harmonic [V]	RO	FLOAT32
40396	395	VTRUE RMS HARMONIC 35 [V] LSW			RO	
40397	396	VTRUE RMS HARMONIC 35 [V] MSW	L3-N	Measurement of the Phase - Neutral VTRUE RMS of the i-th harmonic [V]	RO	FLOAT32
40398	397	VTRUE RMS HARMONIC 35 [V] LSW			RO	

ADDRESS (4x)	ADDRESS OFFSET	REGISTER	PHASE	DESCRIPTION	W/R	TYPE
40399	398	VTRUE RMS HARMONIC 36 [V] MSW	L1-N	Measurement of the Phase - Neutral VTRUE RMS of the i-th harmonic [V]	RO	FLOAT32
40400	399	VTRUE RMS HARMONIC 36 [V] LSW			RO	
40401	400	VTRUE RMS HARMONIC 36 [V] MSW	L2-N	Measurement of the Phase - Neutral VTRUE RMS of the i-th harmonic [V]	RO	FLOAT32
40402	401	VTRUE RMS HARMONIC 36 [V] LSW			RO	
40403	402	VTRUE RMS HARMONIC 36 [V] MSW	L3-N	Measurement of the Phase - Neutral VTRUE RMS of the i-th harmonic [V]	RO	FLOAT32
40404	403	VTRUE RMS HARMONIC 36 [V] LSW			RO	
40405	404	VTRUE RMS HARMONIC 37 [V] MSW	L1-N	Measurement of the Phase - Neutral VTRUE RMS of the i-th harmonic [V]	RO	FLOAT32
40406	405	VTRUE RMS HARMONIC 37 [V] LSW			RO	
40407	406	VTRUE RMS HARMONIC 37 [V] MSW	L2-N	Measurement of the Phase - Neutral VTRUE RMS of the i-th harmonic [V]	RO	FLOAT32
40408	407	VTRUE RMS HARMONIC 37 [V] LSW			RO	
40409	408	VTRUE RMS HARMONIC 37 [V] MSW	L3-N	Measurement of the Phase - Neutral VTRUE RMS of the i-th harmonic [V]	RO	FLOAT32
40410	409	VTRUE RMS HARMONIC 37 [V] LSW			RO	
40411	410	VTRUE RMS HARMONIC 38 [V] MSW	L1-N	Measurement of the Phase - Neutral VTRUE RMS of the i-th harmonic [V]	RO	FLOAT32
40412	411	VTRUE RMS HARMONIC 38 [V] LSW			RO	
40413	412	VTRUE RMS HARMONIC 38 [V] MSW	L2-N	Measurement of the Phase - Neutral VTRUE RMS of the i-th harmonic [V]	RO	FLOAT32
40414	413	VTRUE RMS HARMONIC 38 [V] LSW			RO	
40415	414	VTRUE RMS HARMONIC 38 [V] MSW	L3-N	Measurement of the Phase - Neutral VTRUE RMS of the i-th harmonic [V]	RO	FLOAT32
40416	415	VTRUE RMS HARMONIC 38 [V] LSW			RO	
40417	416	VTRUE RMS HARMONIC 39 [V] MSW	L1-N	Measurement of the Phase - Neutral VTRUE RMS of the i-th harmonic [V]	RO	FLOAT32
40418	417	VTRUE RMS HARMONIC 39 [V] LSW			RO	
40419	418	VTRUE RMS HARMONIC 39 [V] MSW	L2-N	Measurement of the Phase - Neutral VTRUE RMS of the i-th harmonic [V]	RO	FLOAT32
40420	419	VTRUE RMS HARMONIC 39 [V] LSW			RO	
40421	420	VTRUE RMS HARMONIC 39 [V] MSW	L3-N	Measurement of the Phase - Neutral VTRUE RMS of the i-th harmonic [V]	RO	FLOAT32
40422	421	VTRUE RMS HARMONIC 39 [V] LSW			RO	
40423	422	VTRUE RMS HARMONIC 40 [V] MSW	L1-N	Measurement of the Phase - Neutral	RO	FLOAT32
40424	423	VTRUE RMS HARMONIC 40 [V] LSW			RO	

ADDRESS (4x)	ADDRESS OFFSET	REGISTER	PHASE	DESCRIPTION	W/R	TYPE
				VTRUE RMS of the i-th harmonic [V]		
40425	424	VTRUE RMS HARMONIC 40 [V] MSW	L2-N	Measurement of the Phase - Neutral VTRUE RMS of the i-th harmonic [V]	RO	FLOAT32
40426	425	VTRUE RMS HARMONIC 40 [V] LSW			RO	
40427	426	VTRUE RMS HARMONIC 40 [V] MSW	L3-N	Measurement of the Phase - Neutral VTRUE RMS of the i-th harmonic [V]	RO	FLOAT32
40428	427	VTRUE RMS HARMONIC 40 [V] LSW			RO	
40429	428	VTRUE RMS HARMONIC 41 [V] MSW	L1-N	Measurement of the Phase - Neutral VTRUE RMS of the i-th harmonic [V]	RO	FLOAT32
40430	429	VTRUE RMS HARMONIC 41 [V] LSW			RO	
40431	430	VTRUE RMS HARMONIC 41 [V] MSW	L2-N	Measurement of the Phase - Neutral VTRUE RMS of the i-th harmonic [V]	RO	FLOAT32
40432	431	VTRUE RMS HARMONIC 41 [V] LSW			RO	
40433	432	VTRUE RMS HARMONIC 41 [V] MSW	L3-N	Measurement of the Phase - Neutral VTRUE RMS of the i-th harmonic [V]	RO	FLOAT32
40434	433	VTRUE RMS HARMONIC 41 [V] LSW			RO	
40435	434	VTRUE RMS HARMONIC 42 [V] MSW	L1-N	Measurement of the Phase - Neutral VTRUE RMS of the i-th harmonic [V]	RO	FLOAT32
40436	435	VTRUE RMS HARMONIC 42 [V] LSW			RO	
40437	436	VTRUE RMS HARMONIC 42 [V] MSW	L2-N	Measurement of the Phase - Neutral VTRUE RMS of the i-th harmonic [V]	RO	FLOAT32
40438	437	VTRUE RMS HARMONIC 42 [V] LSW			RO	
40439	438	VTRUE RMS HARMONIC 42 [V] MSW	L3-N	Measurement of the Phase - Neutral VTRUE RMS of the i-th harmonic [V]	RO	FLOAT32
40440	439	VTRUE RMS HARMONIC 42 [V] LSW			RO	
40441	440	VTRUE RMS HARMONIC 43 [V] MSW	L1-N	Measurement of the Phase - Neutral VTRUE RMS of the i-th harmonic [V]	RO	FLOAT32
40442	441	VTRUE RMS HARMONIC 43 [V] LSW			RO	
40443	442	VTRUE RMS HARMONIC 43 [V] MSW	L2-N	Measurement of the Phase - Neutral VTRUE RMS of the i-th harmonic [V]	RO	FLOAT32
40444	443	VTRUE RMS HARMONIC 43 [V] LSW			RO	
40445	444	VTRUE RMS HARMONIC 43 [V] MSW	L3-N	Measurement of the Phase - Neutral VTRUE RMS of the i-th harmonic [V]	RO	FLOAT32
40446	445	VTRUE RMS HARMONIC 43 [V] LSW			RO	
40447	446	VTRUE RMS HARMONIC 44 [V] MSW	L1-N	Measurement of the Phase - Neutral VTRUE RMS of the i-th harmonic [V]	RO	FLOAT32
40448	447	VTRUE RMS HARMONIC 44 [V] LSW			RO	

ADDRESS (4x)	ADDRESS OFFSET	REGISTER	PHASE	DESCRIPTION	W/R	TYPE
40449	448	VTRUE RMS HARMONIC 44 [V] MSW	L2-N	Measurement of the Phase - Neutral VTRUE RMS of the i-th harmonic [V]	RO	FLOAT32
40450	449	VTRUE RMS HARMONIC 44 [V] LSW			RO	
40451	450	VTRUE RMS HARMONIC 44 [V] MSW	L3-N	Measurement of the Phase - Neutral VTRUE RMS of the i-th harmonic [V]	RO	FLOAT32
40452	451	VTRUE RMS HARMONIC 44 [V] LSW			RO	
40453	452	VTRUE RMS HARMONIC 45 [V] MSW	L1-N	Measurement of the Phase - Neutral VTRUE RMS of the i-th harmonic [V]	RO	FLOAT32
40454	453	VTRUE RMS HARMONIC 45 [V] LSW			RO	
40455	454	VTRUE RMS HARMONIC 45 [V] MSW	L2-N	Measurement of the Phase - Neutral VTRUE RMS of the i-th harmonic [V]	RO	FLOAT32
40456	455	VTRUE RMS HARMONIC 45 [V] LSW			RO	
40457	456	VTRUE RMS HARMONIC 45 [V] MSW	L3-N	Measurement of the Phase - Neutral VTRUE RMS of the i-th harmonic [V]	RO	FLOAT32
40458	457	VTRUE RMS HARMONIC 45 [V] LSW			RO	
40459	458	VTRUE RMS HARMONIC 46 [V] MSW	L1-N	Measurement of the Phase - Neutral VTRUE RMS of the i-th harmonic [V]	RO	FLOAT32
40460	459	VTRUE RMS HARMONIC 46 [V] LSW			RO	
40461	460	VTRUE RMS HARMONIC 46 [V] MSW	L2-N	Measurement of the Phase - Neutral VTRUE RMS of the i-th harmonic [V]	RO	FLOAT32
40462	461	VTRUE RMS HARMONIC 46 [V] LSW			RO	
40463	462	VTRUE RMS HARMONIC 46 [V] MSW	L3-N	Measurement of the Phase - Neutral VTRUE RMS of the i-th harmonic [V]	RO	FLOAT32
40464	463	VTRUE RMS HARMONIC 46 [V] LSW			RO	
40465	464	VTRUE RMS HARMONIC 47 [V] MSW	L1-N	Measurement of the Phase - Neutral VTRUE RMS of the i-th harmonic [V]	RO	FLOAT32
40466	465	VTRUE RMS HARMONIC 47 [V] LSW			RO	
40467	466	VTRUE RMS HARMONIC 47 [V] MSW	L2-N	Measurement of the Phase - Neutral VTRUE RMS of the i-th harmonic [V]	RO	FLOAT32
40468	467	VTRUE RMS HARMONIC 47 [V] LSW			RO	
40469	468	VTRUE RMS HARMONIC 47 [V] MSW	L3-N	Measurement of the Phase - Neutral VTRUE RMS of the i-th harmonic [V]	RO	FLOAT32
40470	469	VTRUE RMS HARMONIC 47 [V] LSW			RO	
40471	470	VTRUE RMS HARMONIC 48 [V] MSW	L1-N	Measurement of the Phase - Neutral VTRUE RMS of the i-th harmonic [V]	RO	FLOAT32
40472	471	VTRUE RMS HARMONIC 48 [V] LSW			RO	
40473	472	VTRUE RMS HARMONIC 48 [V] MSW	L2-N	Measurement of the Phase - Neutral	RO	FLOAT32
40474	473	VTRUE RMS HARMONIC 48 [V] LSW			RO	

ADDRESS (4x)	ADDRESS OFFSET	REGISTER	PHASE	DESCRIPTION	W/R	TYPE
				VTRUE RMS of the i-th harmonic [V]		
40475	474	VTRUE RMS HARMONIC 48 [V] MSW	L3-N	Measurement of the Phase - Neutral VTRUE RMS of the i-th harmonic [V]	RO	FLOAT32
40476	475	VTRUE RMS HARMONIC 48 [V] LSW			RO	
40477	476	VTRUE RMS HARMONIC 49 [V] MSW	L1-N	Measurement of the Phase - Neutral VTRUE RMS of the i-th harmonic [V]	RO	FLOAT32
40478	477	VTRUE RMS HARMONIC 49 [V] LSW			RO	
40479	478	VTRUE RMS HARMONIC 49 [V] MSW	L2-N	Measurement of the Phase - Neutral VTRUE RMS of the i-th harmonic [V]	RO	FLOAT32
40480	479	VTRUE RMS HARMONIC 49 [V] LSW			RO	
40481	480	VTRUE RMS HARMONIC 49 [V] MSW	L3-N	Measurement of the Phase - Neutral VTRUE RMS of the i-th harmonic [V]	RO	FLOAT32
40482	481	VTRUE RMS HARMONIC 49 [V] LSW			RO	
40483	482	VTRUE RMS HARMONIC 50 [V] MSW	L1-N	Measurement of the Phase - Neutral VTRUE RMS of the i-th harmonic [V]	RO	FLOAT32
40484	483	VTRUE RMS HARMONIC 50 [V] LSW			RO	
40485	484	VTRUE RMS HARMONIC 50 [V] MSW	L2-N	Measurement of the Phase - Neutral VTRUE RMS of the i-th harmonic [V]	RO	FLOAT32
40486	485	VTRUE RMS HARMONIC 50 [V] LSW			RO	
40487	486	VTRUE RMS HARMONIC 50 [V] MSW	L3-N	Measurement of the Phase - Neutral VTRUE RMS of the i-th harmonic [V]	RO	FLOAT32
40488	487	VTRUE RMS HARMONIC 50 [V] LSW			RO	
40489	488	VTRUE RMS HARMONIC 51 [V] MSW	L1-N	Measurement of the Phase - Neutral VTRUE RMS of the i-th harmonic [V]	RO	FLOAT32
40490	489	VTRUE RMS HARMONIC 51 [V] LSW			RO	
40491	490	VTRUE RMS HARMONIC 51 [V] MSW	L2-N	Measurement of the Phase - Neutral VTRUE RMS of the i-th harmonic [V]	RO	FLOAT32
40492	491	VTRUE RMS HARMONIC 51 [V] LSW			RO	
40493	492	VTRUE RMS HARMONIC 51 [V] MSW	L3-N	Measurement of the Phase - Neutral VTRUE RMS of the i-th harmonic [V]	RO	FLOAT32
40494	493	VTRUE RMS HARMONIC 51 [V] LSW			RO	
40495	494	VTRUE RMS HARMONIC 52 [V] MSW	L1-N	Measurement of the Phase - Neutral VTRUE RMS of the i-th harmonic [V]	RO	FLOAT32
40496	495	VTRUE RMS HARMONIC 52 [V] LSW			RO	
40497	496	VTRUE RMS HARMONIC 52 [V] MSW	L2-N	Measurement of the Phase - Neutral VTRUE RMS of the i-th harmonic [V]	RO	FLOAT32
40498	497	VTRUE RMS HARMONIC 52 [V] LSW			RO	

ADDRESS (4x)	ADDRESS OFFSET	REGISTER	PHASE	DESCRIPTION	W/R	TYPE
40499	498	VTRUE RMS HARMONIC 52 [V] MSW	L3-N	Measurement of the Phase - Neutral VTRUE RMS of the i-th harmonic [V]	RO	FLOAT32
40500	499	VTRUE RMS HARMONIC 52 [V] LSW			RO	
40501	500	VTRUE RMS HARMONIC 53 [V] MSW	L1-N	Measurement of the Phase - Neutral VTRUE RMS of the i-th harmonic [V]	RO	FLOAT32
40502	501	VTRUE RMS HARMONIC 53 [V] LSW			RO	
40503	502	VTRUE RMS HARMONIC 53 [V] MSW	L2-N	Measurement of the Phase - Neutral VTRUE RMS of the i-th harmonic [V]	RO	FLOAT32
40504	503	VTRUE RMS HARMONIC 53 [V] LSW			RO	
40505	504	VTRUE RMS HARMONIC 53 [V] MSW	L3-N	Measurement of the Phase - Neutral VTRUE RMS of the i-th harmonic [V]	RO	FLOAT32
40506	505	VTRUE RMS HARMONIC 53 [V] LSW			RO	
40507	506	VTRUE RMS HARMONIC 54 [V] MSW	L1-N	Measurement of the Phase - Neutral VTRUE RMS of the i-th harmonic [V]	RO	FLOAT32
40508	507	VTRUE RMS HARMONIC 54 [V] LSW			RO	
40509	508	VTRUE RMS HARMONIC 54 [V] MSW	L2-N	Measurement of the Phase - Neutral VTRUE RMS of the i-th harmonic [V]	RO	FLOAT32
40510	509	VTRUE RMS HARMONIC 54 [V] LSW			RO	
40511	510	VTRUE RMS HARMONIC 54 [V] MSW	L3-N	Measurement of the Phase - Neutral VTRUE RMS of the i-th harmonic [V]	RO	FLOAT32
40512	511	VTRUE RMS HARMONIC 54 [V] LSW			RO	
40513	512	VTRUE RMS HARMONIC 55 [V] MSW	L1-N	Measurement of the Phase - Neutral VTRUE RMS of the i-th harmonic [V]	RO	FLOAT32
40514	513	VTRUE RMS HARMONIC 55 [V] LSW			RO	
40515	514	VTRUE RMS HARMONIC 55 [V] MSW	L2-N	Measurement of the Phase - Neutral VTRUE RMS of the i-th harmonic [V]	RO	FLOAT32
40516	515	VTRUE RMS HARMONIC 55 [V] LSW			RO	
40517	516	VTRUE RMS HARMONIC 55 [V] MSW	L3-N	Measurement of the Phase - Neutral VTRUE RMS of the i-th harmonic [V]	RO	FLOAT32
40518	517	VTRUE RMS HARMONIC 55 [V] LSW			RO	
40519	518	ITRUE RMS FUNDAMENTAL [A] MSW	L1	Measurement of the phase ITRUE RMS fundamental alone [A]	RO	FLOAT32
40520	519	ITRUE RMS FUNDAMENTAL [A] LSW			RO	
40521	520	ITRUE RMS FUNDAMENTAL [A] MSW	L2	Measurement of the phase ITRUE RMS fundamental alone [A]	RO	FLOAT32
40522	521	ITRUE RMS FUNDAMENTAL [A] LSW			RO	
40523	522	ITRUE RMS FUNDAMENTAL [A] MSW	L3	Measurement of the phase ITRUE	RO	FLOAT32

ADDRESS (4x)	ADDRESS OFFSET	REGISTER	PHASE	DESCRIPTION	W/R	TYPE
40524	523	ITRUE RMS FUNDAMENTAL [A] LSW		RMS fundamental alone [A]	RO	
40525	524	ITRUE RMS HARMONIC 2 [A] MSW	L1	Measurement of the phase ITRUE RMS of the i-th harmonic[A]	RO	FLOAT32
40526	525	ITRUE RMS HARMONIC 2 [A] LSW			RO	
40527	526	ITRUE RMS HARMONIC 2 [A] MSW	L2	Measurement of the phase ITRUE RMS of the i-th harmonic[A]	RO	FLOAT32
40528	527	ITRUE RMS HARMONIC 2 [A] LSW			RO	
40529	528	ITRUE RMS HARMONIC 2 [A] MSW	L3	Measurement of the phase ITRUE RMS of the i-th harmonic[A]	RO	FLOAT32
40530	529	ITRUE RMS HARMONIC 2 [A] LSW			RO	
40531	530	ITRUE RMS HARMONIC 3 [A] MSW	L1	Measurement of the phase ITRUE RMS of the i-th harmonic[A]	RO	FLOAT32
40532	531	ITRUE RMS HARMONIC 3 [A] LSW			RO	
40533	532	ITRUE RMS HARMONIC 3 [A] MSW	L2	Measurement of the phase ITRUE RMS of the i-th harmonic[A]	RO	FLOAT32
40534	533	ITRUE RMS HARMONIC 3 [A] LSW			RO	
40535	534	ITRUE RMS HARMONIC 3 [A] MSW	L3	Measurement of the phase ITRUE RMS of the i-th harmonic[A]	RO	FLOAT32
40536	535	ITRUE RMS HARMONIC 3 [A] LSW			RO	
40537	536	ITRUE RMS HARMONIC 4 [A] MSW	L1	Measurement of the phase ITRUE RMS of the i-th harmonic[A]	RO	FLOAT32
40538	537	ITRUE RMS HARMONIC 4 [A] LSW			RO	
40539	538	ITRUE RMS HARMONIC 4 [A] MSW	L2	Measurement of the phase ITRUE RMS of the i-th harmonic[A]	RO	FLOAT32
40540	539	ITRUE RMS HARMONIC 4 [A] LSW			RO	
40541	540	ITRUE RMS HARMONIC 4 [A] MSW	L3	Measurement of the phase ITRUE RMS of the i-th harmonic[A]	RO	FLOAT32
40542	541	ITRUE RMS HARMONIC 4 [A] LSW			RO	
40543	542	ITRUE RMS HARMONIC 5 [A] MSW	L1	Measurement of the phase ITRUE RMS of the i-th harmonic[A]	RO	FLOAT32
40544	543	ITRUE RMS HARMONIC 5 [A] LSW			RO	
40545	544	ITRUE RMS HARMONIC 5 [A] MSW	L2	Measurement of the phase ITRUE RMS of the i-th harmonic[A]	RO	FLOAT32
40546	545	ITRUE RMS HARMONIC 5 [A] LSW			RO	
40547	546	ITRUE RMS HARMONIC 5 [A] MSW	L3	Measurement of the phase ITRUE RMS of the i-th harmonic[A]	RO	FLOAT32
40548	547	ITRUE RMS HARMONIC 5 [A] LSW			RO	

ADDRESS (4x)	ADDRESS OFFSET	REGISTER	PHASE	DESCRIPTION	W/R	TYPE
40549	548	ITRUE RMS HARMONIC 6 [A] MSW	L1	Measurement of the phase ITRUE RMS of the i-th harmonic[A]	RO	FLOAT32
40550	549	ITRUE RMS HARMONIC 6 [A] LSW			RO	
40551	550	ITRUE RMS HARMONIC 6 [A] MSW	L2	Measurement of the phase ITRUE RMS of the i-th harmonic[A]	RO	FLOAT32
40552	551	ITRUE RMS HARMONIC 6 [A] LSW			RO	
40553	552	ITRUE RMS HARMONIC 6 [A] MSW	L3	Measurement of the phase ITRUE RMS of the i-th harmonic[A]	RO	FLOAT32
40554	553	ITRUE RMS HARMONIC 6 [A] LSW			RO	
40555	554	ITRUE RMS HARMONIC 7 [A] MSW	L1	Measurement of the phase ITRUE RMS of the i-th harmonic[A]	RO	FLOAT32
40556	555	ITRUE RMS HARMONIC 7 [A] LSW			RO	
40557	556	ITRUE RMS HARMONIC 7 [A] MSW	L2	Measurement of the phase ITRUE RMS of the i-th harmonic[A]	RO	FLOAT32
40558	557	ITRUE RMS HARMONIC 7 [A] LSW			RO	
40559	558	ITRUE RMS HARMONIC 7 [A] MSW	L3	Measurement of the phase ITRUE RMS of the i-th harmonic[A]	RO	FLOAT32
40560	559	ITRUE RMS HARMONIC 7 [A] LSW			RO	
40561	560	ITRUE RMS HARMONIC 8 [A] MSW	L1	Measurement of the phase ITRUE RMS of the i-th harmonic[A]	RO	FLOAT32
40562	561	ITRUE RMS HARMONIC 8 [A] LSW			RO	
40563	562	ITRUE RMS HARMONIC 8 [A] MSW	L2	Measurement of the phase ITRUE RMS of the i-th harmonic[A]	RO	FLOAT32
40564	563	ITRUE RMS HARMONIC 8 [A] LSW			RO	
40565	564	ITRUE RMS HARMONIC 8 [A] MSW	L3	Measurement of the phase ITRUE RMS of the i-th harmonic[A]	RO	FLOAT32
40566	565	ITRUE RMS HARMONIC 8 [A] LSW			RO	
40567	566	ITRUE RMS HARMONIC 9 [A] MSW	L1	Measurement of the phase ITRUE RMS of the i-th harmonic[A]	RO	FLOAT32
40568	567	ITRUE RMS HARMONIC 9 [A] LSW			RO	
40569	568	ITRUE RMS HARMONIC 9 [A] MSW	L2	Measurement of the phase ITRUE RMS of the i-th harmonic[A]	RO	FLOAT32
40570	569	ITRUE RMS HARMONIC 9 [A] LSW			RO	
40571	570	ITRUE RMS HARMONIC 9 [A] MSW	L3	Measurement of the phase ITRUE RMS of the i-th harmonic[A]	RO	FLOAT32
40572	571	ITRUE RMS HARMONIC 9 [A] LSW			RO	
40573	572	ITRUE RMS HARMONIC 10 [A] MSW	L1	Measurement of the phase ITRUE	RO	FLOAT32
40574	573	ITRUE RMS HARMONIC 10 [A] LSW			RO	

ADDRESS (4x)	ADDRESS OFFSET	REGISTER	PHASE	DESCRIPTION	W/R	TYPE
				RMS of the i-th harmonic[A]		
40575	574	ITRUE RMS HARMONIC 10 [A] MSW	L2	Measurement of the phase ITRUE RMS of the i-th harmonic[A]	RO	FLOAT32
40576	575	ITRUE RMS HARMONIC 10 [A] LSW			RO	
40577	576	ITRUE RMS HARMONIC 10 [A] MSW	L3	Measurement of the phase ITRUE RMS of the i-th harmonic[A]	RO	FLOAT32
40578	577	ITRUE RMS HARMONIC 10 [A] LSW			RO	
40579	578	ITRUE RMS HARMONIC 11 [A] MSW	L1	Measurement of the phase ITRUE RMS of the i-th harmonic[A]	RO	FLOAT32
40580	579	ITRUE RMS HARMONIC 11 [A] LSW			RO	
40581	580	ITRUE RMS HARMONIC 11 [A] MSW	L2	Measurement of the phase ITRUE RMS of the i-th harmonic[A]	RO	FLOAT32
40582	581	ITRUE RMS HARMONIC 11 [A] LSW			RO	
40583	582	ITRUE RMS HARMONIC 11 [A] MSW	L3	Measurement of the phase ITRUE RMS of the i-th harmonic[A]	RO	FLOAT32
40584	583	ITRUE RMS HARMONIC 11 [A] LSW			RO	
40585	584	ITRUE RMS HARMONIC 12 [A] MSW	L1	Measurement of the phase ITRUE RMS of the i-th harmonic[A]	RO	FLOAT32
40586	585	ITRUE RMS HARMONIC 12 [A] LSW			RO	
40587	586	ITRUE RMS HARMONIC 12 [A] MSW	L2	Measurement of the phase ITRUE RMS of the i-th harmonic[A]	RO	FLOAT32
40588	587	ITRUE RMS HARMONIC 12 [A] LSW			RO	
40589	588	ITRUE RMS HARMONIC 12 [A] MSW	L3	Measurement of the phase ITRUE RMS of the i-th harmonic[A]	RO	FLOAT32
40590	589	ITRUE RMS HARMONIC 12 [A] LSW			RO	
40591	590	ITRUE RMS HARMONIC 13 [A] MSW	L1	Measurement of the phase ITRUE RMS of the i-th harmonic[A]	RO	FLOAT32
40592	591	ITRUE RMS HARMONIC 13 [A] LSW			RO	
40593	592	ITRUE RMS HARMONIC 13 [A] MSW	L2	Measurement of the phase ITRUE RMS of the i-th harmonic[A]	RO	FLOAT32
40594	593	ITRUE RMS HARMONIC 13 [A] LSW			RO	
40595	594	ITRUE RMS HARMONIC 13 [A] MSW	L3	Measurement of the phase ITRUE RMS of the i-th harmonic[A]	RO	FLOAT32
40596	595	ITRUE RMS HARMONIC 13 [A] LSW			RO	
40597	596	ITRUE RMS HARMONIC 14 [A] MSW	L1	Measurement of the phase ITRUE RMS of the i-th harmonic[A]	RO	FLOAT32
40598	597	ITRUE RMS HARMONIC 14 [A] LSW			RO	

ADDRESS (4x)	ADDRESS OFFSET	REGISTER	PHASE	DESCRIPTION	W/R	TYPE
40599	598	ITRUE RMS HARMONIC 14 [A] MSW	L2	Measurement of the phase ITRUE RMS of the i-th harmonic[A]	RO	FLOAT32
40600	599	ITRUE RMS HARMONIC 14 [A] LSW			RO	
40601	600	ITRUE RMS HARMONIC 14 [A] MSW	L3	Measurement of the phase ITRUE RMS of the i-th harmonic[A]	RO	FLOAT32
40602	601	ITRUE RMS HARMONIC 14 [A] LSW			RO	
40603	602	ITRUE RMS HARMONIC 15 [A] MSW	L1	Measurement of the phase ITRUE RMS of the i-th harmonic[A]	RO	FLOAT32
40604	603	ITRUE RMS HARMONIC 15 [A] LSW			RO	
40605	604	ITRUE RMS HARMONIC 15 [A] MSW	L2	Measurement of the phase ITRUE RMS of the i-th harmonic[A]	RO	FLOAT32
40606	605	ITRUE RMS HARMONIC 15 [A] LSW			RO	
40607	606	ITRUE RMS HARMONIC 15 [A] MSW	L3	Measurement of the phase ITRUE RMS of the i-th harmonic[A]	RO	FLOAT32
40608	607	ITRUE RMS HARMONIC 15 [A] LSW			RO	
40609	608	ITRUE RMS HARMONIC 16 [A] MSW	L1	Measurement of the phase ITRUE RMS of the i-th harmonic[A]	RO	FLOAT32
40610	609	ITRUE RMS HARMONIC 16 [A] LSW			RO	
40611	610	ITRUE RMS HARMONIC 16 [A] MSW	L2	Measurement of the phase ITRUE RMS of the i-th harmonic[A]	RO	FLOAT32
40612	611	ITRUE RMS HARMONIC 16 [A] LSW			RO	
40613	612	ITRUE RMS HARMONIC 16 [A] MSW	L3	Measurement of the phase ITRUE RMS of the i-th harmonic[A]	RO	FLOAT32
40614	613	ITRUE RMS HARMONIC 16 [A] LSW			RO	
40615	614	ITRUE RMS HARMONIC 17 [A] MSW	L1	Measurement of the phase ITRUE RMS of the i-th harmonic[A]	RO	FLOAT32
40616	615	ITRUE RMS HARMONIC 17 [A] LSW			RO	
40617	616	ITRUE RMS HARMONIC 17 [A] MSW	L2	Measurement of the phase ITRUE RMS of the i-th harmonic[A]	RO	FLOAT32
40618	617	ITRUE RMS HARMONIC 17 [A] LSW			RO	
40619	618	ITRUE RMS HARMONIC 17 [A] MSW	L3	Measurement of the phase ITRUE RMS of the i-th harmonic[A]	RO	FLOAT32
40620	619	ITRUE RMS HARMONIC 17 [A] LSW			RO	
40621	620	ITRUE RMS HARMONIC 18 [A] MSW	L1	Measurement of the phase ITRUE RMS of the i-th harmonic[A]	RO	FLOAT32
40622	621	ITRUE RMS HARMONIC 18 [A] LSW			RO	
40623	622	ITRUE RMS HARMONIC 18 [A] MSW	L2	Measurement of the phase ITRUE	RO	FLOAT32
40624	623	ITRUE RMS HARMONIC 18 [A] LSW			RO	

ADDRESS (4x)	ADDRESS OFFSET	REGISTER	PHASE	DESCRIPTION	W/R	TYPE
				RMS of the i-th harmonic[A]		
40625	624	ITRUE RMS HARMONIC 18 [A] MSW	L3	Measurement of the phase ITRUE RMS of the i-th harmonic[A]	RO	FLOAT32
40626	625	ITRUE RMS HARMONIC 18 [A] LSW			RO	
40627	626	ITRUE RMS HARMONIC 19 [A] MSW	L1	Measurement of the phase ITRUE RMS of the i-th harmonic[A]	RO	FLOAT32
40628	627	ITRUE RMS HARMONIC 19 [A] LSW			RO	
40629	628	ITRUE RMS HARMONIC 19 [A] MSW	L2	Measurement of the phase ITRUE RMS of the i-th harmonic[A]	RO	FLOAT32
40630	629	ITRUE RMS HARMONIC 19 [A] LSW			RO	
40631	630	ITRUE RMS HARMONIC 19 [A] MSW	L3	Measurement of the phase ITRUE RMS of the i-th harmonic[A]	RO	FLOAT32
40632	631	ITRUE RMS HARMONIC 19 [A] LSW			RO	
40633	632	ITRUE RMS HARMONIC 20 [A] MSW	L1	Measurement of the phase ITRUE RMS of the i-th harmonic[A]	RO	FLOAT32
40634	633	ITRUE RMS HARMONIC 20 [A] LSW			RO	
40635	634	ITRUE RMS HARMONIC 20 [A] MSW	L2	Measurement of the phase ITRUE RMS of the i-th harmonic[A]	RO	FLOAT32
40636	635	ITRUE RMS HARMONIC 20 [A] LSW			RO	
40637	636	ITRUE RMS HARMONIC 20 [A] MSW	L3	Measurement of the phase ITRUE RMS of the i-th harmonic[A]	RO	FLOAT32
40638	637	ITRUE RMS HARMONIC 20 [A] LSW			RO	
40639	638	ITRUE RMS HARMONIC 21 [A] MSW	L1	Measurement of the phase ITRUE RMS of the i-th harmonic[A]	RO	FLOAT32
40640	639	ITRUE RMS HARMONIC 21 [A] LSW			RO	
40641	640	ITRUE RMS HARMONIC 21 [A] MSW	L2	Measurement of the phase ITRUE RMS of the i-th harmonic[A]	RO	FLOAT32
40642	641	ITRUE RMS HARMONIC 21 [A] LSW			RO	
40643	642	ITRUE RMS HARMONIC 21 [A] MSW	L3	Measurement of the phase ITRUE RMS of the i-th harmonic[A]	RO	FLOAT32
40644	643	ITRUE RMS HARMONIC 21 [A] LSW			RO	
40645	644	ITRUE RMS HARMONIC 22 [A] MSW	L1	Measurement of the phase ITRUE RMS of the i-th harmonic[A]	RO	FLOAT32
40646	645	ITRUE RMS HARMONIC 22 [A] LSW			RO	
40647	646	ITRUE RMS HARMONIC 22 [A] MSW	L2	Measurement of the phase ITRUE RMS of the i-th harmonic[A]	RO	FLOAT32
40648	647	ITRUE RMS HARMONIC 22 [A] LSW			RO	

ADDRESS (4x)	ADDRESS OFFSET	REGISTER	PHASE	DESCRIPTION	W/R	TYPE
40649	648	ITRUE RMS HARMONIC 22 [A] MSW	L3	Measurement of the phase ITRUE RMS of the i-th harmonic[A]	RO	FLOAT32
40650	649	ITRUE RMS HARMONIC 22 [A] LSW			RO	
40651	650	ITRUE RMS HARMONIC 23 [A] MSW	L1	Measurement of the phase ITRUE RMS of the i-th harmonic[A]	RO	FLOAT32
40652	651	ITRUE RMS HARMONIC 23 [A] LSW			RO	
40653	652	ITRUE RMS HARMONIC 23 [A] MSW	L2	Measurement of the phase ITRUE RMS of the i-th harmonic[A]	RO	FLOAT32
40654	653	ITRUE RMS HARMONIC 23 [A] LSW			RO	
40655	654	ITRUE RMS HARMONIC 23 [A] MSW	L3	Measurement of the phase ITRUE RMS of the i-th harmonic[A]	RO	FLOAT32
40656	655	ITRUE RMS HARMONIC 23 [A] LSW			RO	
40657	656	ITRUE RMS HARMONIC 24 [A] MSW	L1	Measurement of the phase ITRUE RMS of the i-th harmonic[A]	RO	FLOAT32
40658	657	ITRUE RMS HARMONIC 24 [A] LSW			RO	
40659	658	ITRUE RMS HARMONIC 24 [A] MSW	L2	Measurement of the phase ITRUE RMS of the i-th harmonic[A]	RO	FLOAT32
40660	659	ITRUE RMS HARMONIC 24 [A] LSW			RO	
40661	660	ITRUE RMS HARMONIC 24 [A] MSW	L3	Measurement of the phase ITRUE RMS of the i-th harmonic[A]	RO	FLOAT32
40662	661	ITRUE RMS HARMONIC 24 [A] LSW			RO	
40663	662	ITRUE RMS HARMONIC 25 [A] MSW	L1	Measurement of the phase ITRUE RMS of the i-th harmonic[A]	RO	FLOAT32
40664	663	ITRUE RMS HARMONIC 25 [A] LSW			RO	
40665	664	ITRUE RMS HARMONIC 25 [A] MSW	L2	Measurement of the phase ITRUE RMS of the i-th harmonic[A]	RO	FLOAT32
40666	665	ITRUE RMS HARMONIC 25 [A] LSW			RO	
40667	666	ITRUE RMS HARMONIC 25 [A] MSW	L3	Measurement of the phase ITRUE RMS of the i-th harmonic[A]	RO	FLOAT32
40668	667	ITRUE RMS HARMONIC 25 [A] LSW			RO	
40669	668	ITRUE RMS HARMONIC 26 [A] MSW	L1	Measurement of the phase ITRUE RMS of the i-th harmonic[A]	RO	FLOAT32
40670	669	ITRUE RMS HARMONIC 26 [A] LSW			RO	
40671	670	ITRUE RMS HARMONIC 26 [A] MSW	L2	Measurement of the phase ITRUE RMS of the i-th harmonic[A]	RO	FLOAT32
40672	671	ITRUE RMS HARMONIC 26 [A] LSW			RO	
40673	672	ITRUE RMS HARMONIC 26 [A] MSW	L3	Measurement of the phase ITRUE	RO	FLOAT32
40674	673	ITRUE RMS HARMONIC 26 [A] LSW			RO	

ADDRESS (4x)	ADDRESS OFFSET	REGISTER	PHASE	DESCRIPTION	W/R	TYPE
				RMS of the i-th harmonic[A]		
40675	674	ITRUE RMS HARMONIC 27 [A] MSW	L1	Measurement of the phase ITRUE RMS of the i-th harmonic[A]	RO	FLOAT32
40676	675	ITRUE RMS HARMONIC 27 [A] LSW			RO	
40677	676	ITRUE RMS HARMONIC 27 [A] MSW	L2	Measurement of the phase ITRUE RMS of the i-th harmonic[A]	RO	FLOAT32
40678	677	ITRUE RMS HARMONIC 27 [A] LSW			RO	
40679	678	ITRUE RMS HARMONIC 27 [A] MSW	L3	Measurement of the phase ITRUE RMS of the i-th harmonic[A]	RO	FLOAT32
40680	679	ITRUE RMS HARMONIC 27 [A] LSW			RO	
40681	680	ITRUE RMS HARMONIC 28 [A] MSW	L1	Measurement of the phase ITRUE RMS of the i-th harmonic[A]	RO	FLOAT32
40682	681	ITRUE RMS HARMONIC 28 [A] LSW			RO	
40683	682	ITRUE RMS HARMONIC 28 [A] MSW	L2	Measurement of the phase ITRUE RMS of the i-th harmonic[A]	RO	FLOAT32
40684	683	ITRUE RMS HARMONIC 28 [A] LSW			RO	
40685	684	ITRUE RMS HARMONIC 28 [A] MSW	L3	Measurement of the phase ITRUE RMS of the i-th harmonic[A]	RO	FLOAT32
40686	685	ITRUE RMS HARMONIC 28 [A] LSW			RO	
40687	686	ITRUE RMS HARMONIC 29 [A] MSW	L1	Measurement of the phase ITRUE RMS of the i-th harmonic[A]	RO	FLOAT32
40688	687	ITRUE RMS HARMONIC 29 [A] LSW			RO	
40689	688	ITRUE RMS HARMONIC 29 [A] MSW	L2	Measurement of the phase ITRUE RMS of the i-th harmonic[A]	RO	FLOAT32
40690	689	ITRUE RMS HARMONIC 29 [A] LSW			RO	
40691	690	ITRUE RMS HARMONIC 29 [A] MSW	L3	Measurement of the phase ITRUE RMS of the i-th harmonic[A]	RO	FLOAT32
40692	691	ITRUE RMS HARMONIC 29 [A] LSW			RO	
40693	692	ITRUE RMS HARMONIC 30 [A] MSW	L1	Measurement of the phase ITRUE RMS of the i-th harmonic[A]	RO	FLOAT32
40694	693	ITRUE RMS HARMONIC 30 [A] LSW			RO	
40695	694	ITRUE RMS HARMONIC 30 [A] MSW	L2	Measurement of the phase ITRUE RMS of the i-th harmonic[A]	RO	FLOAT32
40696	695	ITRUE RMS HARMONIC 30 [A] LSW			RO	
40697	696	ITRUE RMS HARMONIC 30 [A] MSW	L3	Measurement of the phase ITRUE RMS of the i-th harmonic[A]	RO	FLOAT32
40698	697	ITRUE RMS HARMONIC 30 [A] LSW			RO	

ADDRESS (4x)	ADDRESS OFFSET	REGISTER	PHASE	DESCRIPTION	W/R	TYPE
40699	698	ITRUE RMS HARMONIC 31 [A] MSW	L1	Measurement of the phase ITRUE RMS of the i-th harmonic[A]	RO	FLOAT32
40700	699	ITRUE RMS HARMONIC 31 [A] LSW			RO	
40701	700	ITRUE RMS HARMONIC 31 [A] MSW	L2	Measurement of the phase ITRUE RMS of the i-th harmonic[A]	RO	FLOAT32
40702	701	ITRUE RMS HARMONIC 31 [A] LSW			RO	
40703	702	ITRUE RMS HARMONIC 31 [A] MSW	L3	Measurement of the phase ITRUE RMS of the i-th harmonic[A]	RO	FLOAT32
40704	703	ITRUE RMS HARMONIC 31 [A] LSW			RO	
40705	704	ITRUE RMS HARMONIC 32 [A] MSW	L1	Measurement of the phase ITRUE RMS of the i-th harmonic[A]	RO	FLOAT32
40706	705	ITRUE RMS HARMONIC 32 [A] LSW			RO	
40707	706	ITRUE RMS HARMONIC 32 [A] MSW	L2	Measurement of the phase ITRUE RMS of the i-th harmonic[A]	RO	FLOAT32
40708	707	ITRUE RMS HARMONIC 32 [A] LSW			RO	
40709	708	ITRUE RMS HARMONIC 32 [A] MSW	L3	Measurement of the phase ITRUE RMS of the i-th harmonic[A]	RO	FLOAT32
40710	709	ITRUE RMS HARMONIC 32 [A] LSW			RO	
40711	710	ITRUE RMS HARMONIC 33 [A] MSW	L1	Measurement of the phase ITRUE RMS of the i-th harmonic[A]	RO	FLOAT32
40712	711	ITRUE RMS HARMONIC 33 [A] LSW			RO	
40713	712	ITRUE RMS HARMONIC 33 [A] MSW	L2	Measurement of the phase ITRUE RMS of the i-th harmonic[A]	RO	FLOAT32
40714	713	ITRUE RMS HARMONIC 33 [A] LSW			RO	
40715	714	ITRUE RMS HARMONIC 33 [A] MSW	L3	Measurement of the phase ITRUE RMS of the i-th harmonic[A]	RO	FLOAT32
40716	715	ITRUE RMS HARMONIC 33 [A] LSW			RO	
40717	716	ITRUE RMS HARMONIC 34 [A] MSW	L1	Measurement of the phase ITRUE RMS of the i-th harmonic[A]	RO	FLOAT32
40718	717	ITRUE RMS HARMONIC 34 [A] LSW			RO	
40719	718	ITRUE RMS HARMONIC 34 [A] MSW	L2	Measurement of the phase ITRUE RMS of the i-th harmonic[A]	RO	FLOAT32
40720	719	ITRUE RMS HARMONIC 34 [A] LSW			RO	
40721	720	ITRUE RMS HARMONIC 34 [A] MSW	L3	Measurement of the phase ITRUE RMS of the i-th harmonic[A]	RO	FLOAT32
40722	721	ITRUE RMS HARMONIC 34 [A] LSW			RO	
40723	722	ITRUE RMS HARMONIC 35 [A] MSW	L1	Measurement of the phase ITRUE	RO	FLOAT32
40724	723	ITRUE RMS HARMONIC 35 [A] LSW			RO	

ADDRESS (4x)	ADDRESS OFFSET	REGISTER	PHASE	DESCRIPTION	W/R	TYPE
				RMS of the i-th harmonic[A]		
40725	724	ITRUE RMS HARMONIC 35 [A] MSW	L2	Measurement of the phase ITRUE RMS of the i-th harmonic[A]	RO	FLOAT32
40726	725	ITRUE RMS HARMONIC 35 [A] LSW			RO	
40727	726	ITRUE RMS HARMONIC 35 [A] MSW	L3	Measurement of the phase ITRUE RMS of the i-th harmonic[A]	RO	FLOAT32
40728	727	ITRUE RMS HARMONIC 35 [A] LSW			RO	
40729	728	ITRUE RMS HARMONIC 36 [A] MSW	L1	Measurement of the phase ITRUE RMS of the i-th harmonic[A]	RO	FLOAT32
40730	729	ITRUE RMS HARMONIC 36 [A] LSW			RO	
40731	730	ITRUE RMS HARMONIC 36 [A] MSW	L2	Measurement of the phase ITRUE RMS of the i-th harmonic[A]	RO	FLOAT32
40732	731	ITRUE RMS HARMONIC 36 [A] LSW			RO	
40733	732	ITRUE RMS HARMONIC 36 [A] MSW	L3	Measurement of the phase ITRUE RMS of the i-th harmonic[A]	RO	FLOAT32
40734	733	ITRUE RMS HARMONIC 36 [A] LSW			RO	
40735	734	ITRUE RMS HARMONIC 37 [A] MSW	L1	Measurement of the phase ITRUE RMS of the i-th harmonic[A]	RO	FLOAT32
40736	735	ITRUE RMS HARMONIC 37 [A] LSW			RO	
40737	736	ITRUE RMS HARMONIC 37 [A] MSW	L2	Measurement of the phase ITRUE RMS of the i-th harmonic[A]	RO	FLOAT32
40738	737	ITRUE RMS HARMONIC 37 [A] LSW			RO	
40739	738	ITRUE RMS HARMONIC 37 [A] MSW	L3	Measurement of the phase ITRUE RMS of the i-th harmonic[A]	RO	FLOAT32
40740	739	ITRUE RMS HARMONIC 37 [A] LSW			RO	
40741	740	ITRUE RMS HARMONIC 38 [A] MSW	L1	Measurement of the phase ITRUE RMS of the i-th harmonic[A]	RO	FLOAT32
40742	741	ITRUE RMS HARMONIC 38 [A] LSW			RO	
40743	742	ITRUE RMS HARMONIC 38 [A] MSW	L2	Measurement of the phase ITRUE RMS of the i-th harmonic[A]	RO	FLOAT32
40744	743	ITRUE RMS HARMONIC 38 [A] LSW			RO	
40745	744	ITRUE RMS HARMONIC 38 [A] MSW	L3	Measurement of the phase ITRUE RMS of the i-th harmonic[A]	RO	FLOAT32
40746	745	ITRUE RMS HARMONIC 38 [A] LSW			RO	
40747	746	ITRUE RMS HARMONIC 39 [A] MSW	L1	Measurement of the phase ITRUE RMS of the i-th harmonic[A]	RO	FLOAT32
40748	747	ITRUE RMS HARMONIC 39 [A] LSW			RO	

ADDRESS (4x)	ADDRESS OFFSET	REGISTER	PHASE	DESCRIPTION	W/R	TYPE
40749	748	ITRUE RMS HARMONIC 39 [A] MSW	L2	Measurement of the phase ITRUE RMS of the i-th harmonic[A]	RO	FLOAT32
40750	749	ITRUE RMS HARMONIC 39 [A] LSW			RO	
40751	750	ITRUE RMS HARMONIC 39 [A] MSW	L3	Measurement of the phase ITRUE RMS of the i-th harmonic[A]	RO	FLOAT32
40752	751	ITRUE RMS HARMONIC 39 [A] LSW			RO	
40753	752	ITRUE RMS HARMONIC 40 [A] MSW	L1	Measurement of the phase ITRUE RMS of the i-th harmonic[A]	RO	FLOAT32
40754	753	ITRUE RMS HARMONIC 40 [A] LSW			RO	
40755	754	ITRUE RMS HARMONIC 40 [A] MSW	L2	Measurement of the phase ITRUE RMS of the i-th harmonic[A]	RO	FLOAT32
40756	755	ITRUE RMS HARMONIC 40 [A] LSW			RO	
40757	756	ITRUE RMS HARMONIC 40 [A] MSW	L3	Measurement of the phase ITRUE RMS of the i-th harmonic[A]	RO	FLOAT32
40758	757	ITRUE RMS HARMONIC 40 [A] LSW			RO	
40759	758	ITRUE RMS HARMONIC 41 [A] MSW	L1	Measurement of the phase ITRUE RMS of the i-th harmonic[A]	RO	FLOAT32
40760	759	ITRUE RMS HARMONIC 41 [A] LSW			RO	
40761	760	ITRUE RMS HARMONIC 41 [A] MSW	L2	Measurement of the phase ITRUE RMS of the i-th harmonic[A]	RO	FLOAT32
40762	761	ITRUE RMS HARMONIC 41 [A] LSW			RO	
40763	762	ITRUE RMS HARMONIC 41 [A] MSW	L3	Measurement of the phase ITRUE RMS of the i-th harmonic[A]	RO	FLOAT32
40764	763	ITRUE RMS HARMONIC 41 [A] LSW			RO	
40765	764	ITRUE RMS HARMONIC 42 [A] MSW	L1	Measurement of the phase ITRUE RMS of the i-th harmonic[A]	RO	FLOAT32
40766	765	ITRUE RMS HARMONIC 42 [A] LSW			RO	
40767	766	ITRUE RMS HARMONIC 42 [A] MSW	L2	Measurement of the phase ITRUE RMS of the i-th harmonic[A]	RO	FLOAT32
40768	767	ITRUE RMS HARMONIC 42 [A] LSW			RO	
40769	768	ITRUE RMS HARMONIC 42 [A] MSW	L3	Measurement of the phase ITRUE RMS of the i-th harmonic[A]	RO	FLOAT32
40770	769	ITRUE RMS HARMONIC 42 [A] LSW			RO	
40771	770	ITRUE RMS HARMONIC 43 [A] MSW	L1	Measurement of the phase ITRUE RMS of the i-th harmonic[A]	RO	FLOAT32
40772	771	ITRUE RMS HARMONIC 43 [A] LSW			RO	
40773	772	ITRUE RMS HARMONIC 43 [A] MSW	L2	Measurement of the phase ITRUE	RO	FLOAT32
40774	773	ITRUE RMS HARMONIC 43 [A] LSW			RO	

ADDRESS (4x)	ADDRESS OFFSET	REGISTER	PHASE	DESCRIPTION	W/R	TYPE
				RMS of the i-th harmonic[A]		
40775	774	ITRUE RMS HARMONIC 43 [A] MSW	L3	Measurement of the phase ITRUE RMS of the i-th harmonic[A]	RO	FLOAT32
40776	775	ITRUE RMS HARMONIC 43 [A] LSW			RO	
40777	776	ITRUE RMS HARMONIC 44 [A] MSW	L1	Measurement of the phase ITRUE RMS of the i-th harmonic[A]	RO	FLOAT32
40778	777	ITRUE RMS HARMONIC 44 [A] LSW			RO	
40779	778	ITRUE RMS HARMONIC 44 [A] MSW	L2	Measurement of the phase ITRUE RMS of the i-th harmonic[A]	RO	FLOAT32
40780	779	ITRUE RMS HARMONIC 44 [A] LSW			RO	
40781	780	ITRUE RMS HARMONIC 44 [A] MSW	L3	Measurement of the phase ITRUE RMS of the i-th harmonic[A]	RO	FLOAT32
40782	781	ITRUE RMS HARMONIC 44 [A] LSW			RO	
40783	782	ITRUE RMS HARMONIC 45 [A] MSW	L1	Measurement of the phase ITRUE RMS of the i-th harmonic[A]	RO	FLOAT32
40784	783	ITRUE RMS HARMONIC 45 [A] LSW			RO	
40785	784	ITRUE RMS HARMONIC 45 [A] MSW	L2	Measurement of the phase ITRUE RMS of the i-th harmonic[A]	RO	FLOAT32
40786	785	ITRUE RMS HARMONIC 45 [A] LSW			RO	
40787	786	ITRUE RMS HARMONIC 45 [A] MSW	L3	Measurement of the phase ITRUE RMS of the i-th harmonic[A]	RO	FLOAT32
40788	787	ITRUE RMS HARMONIC 45 [A] LSW			RO	
40789	788	ITRUE RMS HARMONIC 46 [A] MSW	L1	Measurement of the phase ITRUE RMS of the i-th harmonic[A]	RO	FLOAT32
40790	789	ITRUE RMS HARMONIC 46 [A] LSW			RO	
40791	790	ITRUE RMS HARMONIC 46 [A] MSW	L2	Measurement of the phase ITRUE RMS of the i-th harmonic[A]	RO	FLOAT32
40792	791	ITRUE RMS HARMONIC 46 [A] LSW			RO	
40793	792	ITRUE RMS HARMONIC 46 [A] MSW	L3	Measurement of the phase ITRUE RMS of the i-th harmonic[A]	RO	FLOAT32
40794	793	ITRUE RMS HARMONIC 46 [A] LSW			RO	
40795	794	ITRUE RMS HARMONIC 47 [A] MSW	L1	Measurement of the phase ITRUE RMS of the i-th harmonic[A]	RO	FLOAT32
40796	795	ITRUE RMS HARMONIC 47 [A] LSW			RO	
40797	796	ITRUE RMS HARMONIC 47 [A] MSW	L2	Measurement of the phase ITRUE RMS of the i-th harmonic[A]	RO	FLOAT32
40798	797	ITRUE RMS HARMONIC 47 [A] LSW			RO	

ADDRESS (4x)	ADDRESS OFFSET	REGISTER	PHASE	DESCRIPTION	W/R	TYPE
40799	798	ITRUE RMS HARMONIC 47 [A] MSW	L3	Measurement of the phase ITRUE RMS of the i-th harmonic[A]	RO	FLOAT32
40800	799	ITRUE RMS HARMONIC 47 [A] LSW			RO	
40801	800	ITRUE RMS HARMONIC 48 [A] MSW	L1	Measurement of the phase ITRUE RMS of the i-th harmonic[A]	RO	FLOAT32
40802	801	ITRUE RMS HARMONIC 48 [A] LSW			RO	
40803	802	ITRUE RMS HARMONIC 48 [A] MSW	L2	Measurement of the phase ITRUE RMS of the i-th harmonic[A]	RO	FLOAT32
40804	803	ITRUE RMS HARMONIC 48 [A] LSW			RO	
40805	804	ITRUE RMS HARMONIC 48 [A] MSW	L3	Measurement of the phase ITRUE RMS of the i-th harmonic[A]	RO	FLOAT32
40806	805	ITRUE RMS HARMONIC 48 [A] LSW			RO	
40807	806	ITRUE RMS HARMONIC 49 [A] MSW	L1	Measurement of the phase ITRUE RMS of the i-th harmonic[A]	RO	FLOAT32
40808	807	ITRUE RMS HARMONIC 49 [A] LSW			RO	
40809	808	ITRUE RMS HARMONIC 49 [A] MSW	L2	Measurement of the phase ITRUE RMS of the i-th harmonic[A]	RO	FLOAT32
40810	809	ITRUE RMS HARMONIC 49 [A] LSW			RO	
40811	810	ITRUE RMS HARMONIC 49 [A] MSW	L3	Measurement of the phase ITRUE RMS of the i-th harmonic[A]	RO	FLOAT32
40812	811	ITRUE RMS HARMONIC 49 [A] LSW			RO	
40813	812	ITRUE RMS HARMONIC 50 [A] MSW	L1	Measurement of the phase ITRUE RMS of the i-th harmonic[A]	RO	FLOAT32
40814	813	ITRUE RMS HARMONIC 50 [A] LSW			RO	
40815	814	ITRUE RMS HARMONIC 50 [A] MSW	L2	Measurement of the phase ITRUE RMS of the i-th harmonic[A]	RO	FLOAT32
40816	815	ITRUE RMS HARMONIC 50 [A] LSW			RO	
40817	816	ITRUE RMS HARMONIC 50 [A] MSW	L3	Measurement of the phase ITRUE RMS of the i-th harmonic[A]	RO	FLOAT32
40818	817	ITRUE RMS HARMONIC 50 [A] LSW			RO	
40819	818	ITRUE RMS HARMONIC 51 [A] MSW	L1	Measurement of the phase ITRUE RMS of the i-th harmonic[A]	RO	FLOAT32
40820	819	ITRUE RMS HARMONIC 51 [A] LSW			RO	
40821	820	ITRUE RMS HARMONIC 51 [A] MSW	L2	Measurement of the phase ITRUE RMS of the i-th harmonic[A]	RO	FLOAT32
40822	821	ITRUE RMS HARMONIC 51 [A] LSW			RO	
40823	822	ITRUE RMS HARMONIC 51 [A] MSW	L3	Measurement of the phase ITRUE	RO	FLOAT32
40824	823	ITRUE RMS HARMONIC 51 [A] LSW			RO	

ADDRESS (4x)	ADDRESS OFFSET	REGISTER	PHASE	DESCRIPTION	W/R	TYPE
				RMS of the i-th harmonic[A]		
40825	824	ITRUE RMS HARMONIC 52 [A] MSW	L1	Measurement of the phase ITRUE RMS of the i-th harmonic[A]	RO	FLOAT32
40826	825	ITRUE RMS HARMONIC 52 [A] LSW			RO	
40827	826	ITRUE RMS HARMONIC 52 [A] MSW	L2	Measurement of the phase ITRUE RMS of the i-th harmonic[A]	RO	FLOAT32
40828	827	ITRUE RMS HARMONIC 52 [A] LSW			RO	
40829	828	ITRUE RMS HARMONIC 52 [A] MSW	L3	Measurement of the phase ITRUE RMS of the i-th harmonic[A]	RO	FLOAT32
40830	829	ITRUE RMS HARMONIC 52 [A] LSW			RO	
40831	830	ITRUE RMS HARMONIC 53 [A] MSW	L1	Measurement of the phase ITRUE RMS of the i-th harmonic[A]	RO	FLOAT32
40832	831	ITRUE RMS HARMONIC 53 [A] LSW			RO	
40833	832	ITRUE RMS HARMONIC 53 [A] MSW	L2	Measurement of the phase ITRUE RMS of the i-th harmonic[A]	RO	FLOAT32
40834	833	ITRUE RMS HARMONIC 53 [A] LSW			RO	
40835	834	ITRUE RMS HARMONIC 53 [A] MSW	L3	Measurement of the phase ITRUE RMS of the i-th harmonic[A]	RO	FLOAT32
40836	835	ITRUE RMS HARMONIC 53 [A] LSW			RO	
40837	836	ITRUE RMS HARMONIC 54 [A] MSW	L1	Measurement of the phase ITRUE RMS of the i-th harmonic[A]	RO	FLOAT32
40838	837	ITRUE RMS HARMONIC 54 [A] LSW			RO	
40839	838	ITRUE RMS HARMONIC 54 [A] MSW	L2	Measurement of the phase ITRUE RMS of the i-th harmonic[A]	RO	FLOAT32
40840	839	ITRUE RMS HARMONIC 54 [A] LSW			RO	
40841	840	ITRUE RMS HARMONIC 54 [A] MSW	L3	Measurement of the phase ITRUE RMS of the i-th harmonic[A]	RO	FLOAT32
40842	841	ITRUE RMS HARMONIC 54 [A] LSW			RO	
40843	842	ITRUE RMS HARMONIC 55 [A] MSW	L1	Measurement of the phase ITRUE RMS of the i-th harmonic[A]	RO	FLOAT32
40844	843	ITRUE RMS HARMONIC 55 [A] LSW			RO	
40845	844	ITRUE RMS HARMONIC 55 [A] MSW	L2	Measurement of the phase ITRUE RMS of the i-th harmonic[A]	RO	FLOAT32
40846	845	ITRUE RMS HARMONIC 55 [A] LSW			RO	
40847	846	ITRUE RMS HARMONIC 55 [A] MSW	L3	Measurement of the phase ITRUE RMS of the i-th harmonic[A]	RO	FLOAT32
40848	847	ITRUE RMS HARMONIC 55 [A] LSW			RO	

ADDRESS (4x)	ADDRESS OFFSET	REGISTER	PHASE	DESCRIPTION	W/R	TYPE
40849	848	VTRUE RMS HARMONIC 2 [%] MSW	L1-N	Measurement of the Phase - Neutral voltage of the i-th harmonic in comparison with the fundamental [%]	RO	FLOAT32
40850	849	VTRUE RMS HARMONIC 2 [%] LSW			RO	
40851	850	VTRUE RMS HARMONIC 2 [%] MSW	L2-N	Measurement of the Phase - Neutral voltage of the i-th harmonic in comparison with the fundamental [%]	RO	FLOAT32
40852	851	VTRUE RMS HARMONIC 2 [%] LSW			RO	
40853	852	VTRUE RMS HARMONIC 2 [%] MSW	L3-N	Measurement of the Phase - Neutral voltage of the i-th harmonic in comparison with the fundamental [%]	RO	FLOAT32
40854	853	VTRUE RMS HARMONIC 2 [%] LSW			RO	
40855	854	VTRUE RMS HARMONIC 3 [%] MSW	L1-N	Measurement of the Phase - Neutral voltage of the i-th harmonic in comparison with the fundamental [%]	RO	FLOAT32
40856	855	VTRUE RMS HARMONIC 3 [%] LSW			RO	
40857	856	VTRUE RMS HARMONIC 3 [%] MSW	L2-N	Measurement of the Phase - Neutral voltage of the i-th harmonic in comparison with the fundamental [%]	RO	FLOAT32
40858	857	VTRUE RMS HARMONIC 3 [%] LSW			RO	
40859	858	VTRUE RMS HARMONIC 3 [%] MSW	L3-N	Measurement of the Phase - Neutral voltage of the i-th harmonic in comparison with the fundamental [%]	RO	FLOAT32
40860	859	VTRUE RMS HARMONIC 3 [%] LSW			RO	
40861	860	VTRUE RMS HARMONIC 4 [%] MSW	L1-N	Measurement of the Phase - Neutral voltage of the i-th	RO	FLOAT32
40862	861	VTRUE RMS HARMONIC 4 [%] LSW			RO	

ADDRESS (4x)	ADDRESS OFFSET	REGISTER	PHASE	DESCRIPTION	W/R	TYPE
				harmonic in comparison with the fundamental [%]		
40863	862	VTRUE RMS HARMONIC 4 [%] MSW	L2-N	Measurement of the Phase - Neutral voltage of the i-th harmonic in comparison with the fundamental [%]	RO	FLOAT32
40864	863	VTRUE RMS HARMONIC 4 [%] LSW			RO	
40865	864	VTRUE RMS HARMONIC 4 [%] MSW	L3-N	Measurement of the Phase - Neutral voltage of the i-th harmonic in comparison with the fundamental [%]	RO	FLOAT32
40866	865	VTRUE RMS HARMONIC 4 [%] LSW			RO	
40867	866	VTRUE RMS HARMONIC 5 [%] MSW	L1-N	Measurement of the Phase - Neutral voltage of the i-th harmonic in comparison with the fundamental [%]	RO	FLOAT32
40868	867	VTRUE RMS HARMONIC 5 [%] LSW			RO	
40869	868	VTRUE RMS HARMONIC 5 [%] MSW	L2-N	Measurement of the Phase - Neutral voltage of the i-th harmonic in comparison with the fundamental [%]	RO	FLOAT32
40870	869	VTRUE RMS HARMONIC 5 [%] LSW			RO	
40871	870	VTRUE RMS HARMONIC 5 [%] MSW	L3-N	Measurement of the Phase - Neutral voltage of the i-th harmonic in comparison with the fundamental [%]	RO	FLOAT32
40872	871	VTRUE RMS HARMONIC 5 [%] LSW			RO	
40873	872	VTRUE RMS HARMONIC 6 [%] MSW	L1-N	Measurement of the Phase - Neutral voltage of the i-th harmonic in comparison with	RO	FLOAT32
40874	873	VTRUE RMS HARMONIC 6 [%] LSW			RO	

ADDRESS (4x)	ADDRESS OFFSET	REGISTER	PHASE	DESCRIPTION	W/R	TYPE
				the fundamental [%]		
40875	874	VTRUE RMS HARMONIC 6 [%] MSW	L2-N	Measurement of the Phase - Neutral voltage of the i-th harmonic in comparison with the fundamental [%]	RO	FLOAT32
40876	875	VTRUE RMS HARMONIC 6 [%] LSW			RO	
40877	876	VTRUE RMS HARMONIC 6 [%] MSW	L3-N	Measurement of the Phase - Neutral voltage of the i-th harmonic in comparison with the fundamental [%]	RO	FLOAT32
40878	877	VTRUE RMS HARMONIC 6 [%] LSW			RO	
40879	878	VTRUE RMS HARMONIC 7 [%] MSW	L1-N	Measurement of the Phase - Neutral voltage of the i-th harmonic in comparison with the fundamental [%]	RO	FLOAT32
40880	879	VTRUE RMS HARMONIC 7 [%] LSW			RO	
40881	880	VTRUE RMS HARMONIC 7 [%] MSW	L2-N	Measurement of the Phase - Neutral voltage of the i-th harmonic in comparison with the fundamental [%]	RO	FLOAT32
40882	881	VTRUE RMS HARMONIC 7 [%] LSW			RO	
40883	882	VTRUE RMS HARMONIC 7 [%] MSW	L3-N	Measurement of the Phase - Neutral voltage of the i-th harmonic in comparison with the fundamental [%]	RO	FLOAT32
40884	883	VTRUE RMS HARMONIC 7 [%] LSW			RO	
40885	884	VTRUE RMS HARMONIC 8 [%] MSW	L1-N	Measurement of the Phase - Neutral voltage of the i-th harmonic in comparison with the fundamental [%]	RO	FLOAT32
40886	885	VTRUE RMS HARMONIC 8 [%] LSW			RO	

ADDRESS (4x)	ADDRESS OFFSET	REGISTER	PHASE	DESCRIPTION	W/R	TYPE
40887	886	VTRUE RMS HARMONIC 8 [%] MSW	L2-N	Measurement of the Phase - Neutral voltage of the i-th harmonic in comparison with the fundamental [%]	RO	FLOAT32
40888	887	VTRUE RMS HARMONIC 8 [%] LSW			RO	
40889	888	VTRUE RMS HARMONIC 8 [%] MSW	L3-N	Measurement of the Phase - Neutral voltage of the i-th harmonic in comparison with the fundamental [%]	RO	FLOAT32
40890	889	VTRUE RMS HARMONIC 8 [%] LSW			RO	
40891	890	VTRUE RMS HARMONIC 9 [%] MSW	L1-N	Measurement of the Phase - Neutral voltage of the i-th harmonic in comparison with the fundamental [%]	RO	FLOAT32
40892	891	VTRUE RMS HARMONIC 9 [%] LSW			RO	
40893	892	VTRUE RMS HARMONIC 9 [%] MSW	L2-N	Measurement of the Phase - Neutral voltage of the i-th harmonic in comparison with the fundamental [%]	RO	FLOAT32
40894	893	VTRUE RMS HARMONIC 9 [%] LSW			RO	
40895	894	VTRUE RMS HARMONIC 9 [%] MSW	L3-N	Measurement of the Phase - Neutral voltage of the i-th harmonic in comparison with the fundamental [%]	RO	FLOAT32
40896	895	VTRUE RMS HARMONIC 9 [%] LSW			RO	
40897	896	VTRUE RMS HARMONIC 10 [%] MSW	L1-N	Measurement of the Phase - Neutral voltage of the i-th harmonic in comparison with the fundamental [%]	RO	FLOAT32
40898	897	VTRUE RMS HARMONIC 10 [%] LSW			RO	
40899	898	VTRUE RMS HARMONIC 10 [%] MSW	L2-N	Measurement of the Phase - Neutral	RO	FLOAT32
40900	899	VTRUE RMS HARMONIC 10 [%] LSW			RO	

ADDRESS (4x)	ADDRESS OFFSET	REGISTER	PHASE	DESCRIPTION	W/R	TYPE
				voltage of the i-th harmonic in comparison with the fundamental [%]		
40901	900	VTRUE RMS HARMONIC 10 [%] MSW	L3-N	Measurement of the Phase - Neutral voltage of the i-th harmonic in comparison with the fundamental [%]	RO	FLOAT32
40902	901	VTRUE RMS HARMONIC 10 [%] LSW			RO	
40903	902	VTRUE RMS HARMONIC 11 [%] MSW	L1-N	Measurement of the Phase - Neutral voltage of the i-th harmonic in comparison with the fundamental [%]	RO	FLOAT32
40904	903	VTRUE RMS HARMONIC 11 [%] LSW			RO	
40905	904	VTRUE RMS HARMONIC 11 [%] MSW	L2-N	Measurement of the Phase - Neutral voltage of the i-th harmonic in comparison with the fundamental [%]	RO	FLOAT32
40906	905	VTRUE RMS HARMONIC 11 [%] LSW			RO	
40907	906	VTRUE RMS HARMONIC 11 [%] MSW	L3-N	Measurement of the Phase - Neutral voltage of the i-th harmonic in comparison with the fundamental [%]	RO	FLOAT32
40908	907	VTRUE RMS HARMONIC 11 [%] LSW			RO	
40909	908	VTRUE RMS HARMONIC 12 [%] MSW	L1-N	Measurement of the Phase - Neutral voltage of the i-th harmonic in comparison with the fundamental [%]	RO	FLOAT32
40910	909	VTRUE RMS HARMONIC 12 [%] LSW			RO	
40911	910	VTRUE RMS HARMONIC 12 [%] MSW	L2-N	Measurement of the Phase - Neutral voltage of the i-th harmonic in	RO	FLOAT32
40912	911	VTRUE RMS HARMONIC 12 [%] LSW			RO	

ADDRESS (4x)	ADDRESS OFFSET	REGISTER	PHASE	DESCRIPTION	W/R	TYPE
				comparison with the fundamental [%]		
40913	912	VTRUE RMS HARMONIC 12 [%] MSW	L3-N	Measurement of the Phase - Neutral voltage of the i-th harmonic in comparison with the fundamental [%]	RO	FLOAT32
40914	913	VTRUE RMS HARMONIC 12 [%] LSW			RO	
40915	914	VTRUE RMS HARMONIC 13 [%] MSW	L1-N	Measurement of the Phase - Neutral voltage of the i-th harmonic in comparison with the fundamental [%]	RO	FLOAT32
40916	915	VTRUE RMS HARMONIC 13 [%] LSW			RO	
40917	916	VTRUE RMS HARMONIC 13 [%] MSW	L2-N	Measurement of the Phase - Neutral voltage of the i-th harmonic in comparison with the fundamental [%]	RO	FLOAT32
40918	917	VTRUE RMS HARMONIC 13 [%] LSW			RO	
40919	918	VTRUE RMS HARMONIC 13 [%] MSW	L3-N	Measurement of the Phase - Neutral voltage of the i-th harmonic in comparison with the fundamental [%]	RO	FLOAT32
40920	919	VTRUE RMS HARMONIC 13 [%] LSW			RO	
40921	920	VTRUE RMS HARMONIC 14 [%] MSW	L1-N	Measurement of the Phase - Neutral voltage of the i-th harmonic in comparison with the fundamental [%]	RO	FLOAT32
40922	921	VTRUE RMS HARMONIC 14 [%] LSW			RO	
40923	922	VTRUE RMS HARMONIC 14 [%] MSW	L2-N	Measurement of the Phase - Neutral voltage of the i-th harmonic in comparison with	RO	FLOAT32
40924	923	VTRUE RMS HARMONIC 14 [%] LSW			RO	

ADDRESS (4x)	ADDRESS OFFSET	REGISTER	PHASE	DESCRIPTION	W/R	TYPE
				the fundamental [%]		
40925	924	VTRUE RMS HARMONIC 14 [%] MSW	L3-N	Measurement of the Phase - Neutral voltage of the i-th harmonic in comparison with the fundamental [%]	RO	FLOAT32
40926	925	VTRUE RMS HARMONIC 14 [%] LSW			RO	
40927	926	VTRUE RMS HARMONIC 15 [%] MSW	L1-N	Measurement of the Phase - Neutral voltage of the i-th harmonic in comparison with the fundamental [%]	RO	FLOAT32
40928	927	VTRUE RMS HARMONIC 15 [%] LSW			RO	
40929	928	VTRUE RMS HARMONIC 15 [%] MSW	L2-N	Measurement of the Phase - Neutral voltage of the i-th harmonic in comparison with the fundamental [%]	RO	FLOAT32
40930	929	VTRUE RMS HARMONIC 15 [%] LSW			RO	
40931	930	VTRUE RMS HARMONIC 15 [%] MSW	L3-N	Measurement of the Phase - Neutral voltage of the i-th harmonic in comparison with the fundamental [%]	RO	FLOAT32
40932	931	VTRUE RMS HARMONIC 15 [%] LSW			RO	
40933	932	VTRUE RMS HARMONIC 16 [%] MSW	L1-N	Measurement of the Phase - Neutral voltage of the i-th harmonic in comparison with the fundamental [%]	RO	FLOAT32
40934	933	VTRUE RMS HARMONIC 16 [%] LSW			RO	
40935	934	VTRUE RMS HARMONIC 16 [%] MSW	L2-N	Measurement of the Phase - Neutral voltage of the i-th harmonic in comparison with the fundamental [%]	RO	FLOAT32
40936	935	VTRUE RMS HARMONIC 16 [%] LSW			RO	

ADDRESS (4x)	ADDRESS OFFSET	REGISTER	PHASE	DESCRIPTION	W/R	TYPE
40937	936	VTRUE RMS HARMONIC 16 [%] MSW	L3-N	Measurement of the Phase - Neutral voltage of the i-th harmonic in comparison with the fundamental [%]	RO	FLOAT32
40938	937	VTRUE RMS HARMONIC 16 [%] LSW			RO	
40939	938	VTRUE RMS HARMONIC 17 [%] MSW	L1-N	Measurement of the Phase - Neutral voltage of the i-th harmonic in comparison with the fundamental [%]	RO	FLOAT32
40940	939	VTRUE RMS HARMONIC 17 [%] LSW			RO	
40941	940	VTRUE RMS HARMONIC 17 [%] MSW	L2-N	Measurement of the Phase - Neutral voltage of the i-th harmonic in comparison with the fundamental [%]	RO	FLOAT32
40942	941	VTRUE RMS HARMONIC 17 [%] LSW			RO	
40943	942	VTRUE RMS HARMONIC 17 [%] MSW	L3-N	Measurement of the Phase - Neutral voltage of the i-th harmonic in comparison with the fundamental [%]	RO	FLOAT32
40944	943	VTRUE RMS HARMONIC 17 [%] LSW			RO	
40945	944	VTRUE RMS HARMONIC 18 [%] MSW	L1-N	Measurement of the Phase - Neutral voltage of the i-th harmonic in comparison with the fundamental [%]	RO	FLOAT32
40946	945	VTRUE RMS HARMONIC 18 [%] LSW			RO	
40947	946	VTRUE RMS HARMONIC 18 [%] MSW	L2-N	Measurement of the Phase - Neutral voltage of the i-th harmonic in comparison with the fundamental [%]	RO	FLOAT32
40948	947	VTRUE RMS HARMONIC 18 [%] LSW			RO	
40949	948	VTRUE RMS HARMONIC 18 [%] MSW	L3-N	Measurement of the Phase - Neutral	RO	FLOAT32
40950	949	VTRUE RMS HARMONIC 18 [%] LSW			RO	

ADDRESS (4x)	ADDRESS OFFSET	REGISTER	PHASE	DESCRIPTION	W/R	TYPE
				voltage of the i-th harmonic in comparison with the fundamental [%]		
40951	950	VTRUE RMS HARMONIC 19 [%] MSW	L1-N	Measurement of the Phase - Neutral voltage of the i-th harmonic in comparison with the fundamental [%]	RO	FLOAT32
40952	951	VTRUE RMS HARMONIC 19 [%] LSW			RO	
40953	952	VTRUE RMS HARMONIC 19 [%] MSW	L2-N	Measurement of the Phase - Neutral voltage of the i-th harmonic in comparison with the fundamental [%]	RO	FLOAT32
40954	953	VTRUE RMS HARMONIC 19 [%] LSW			RO	
40955	954	VTRUE RMS HARMONIC 19 [%] MSW	L3-N	Measurement of the Phase - Neutral voltage of the i-th harmonic in comparison with the fundamental [%]	RO	FLOAT32
40956	955	VTRUE RMS HARMONIC 19 [%] LSW			RO	
40957	956	VTRUE RMS HARMONIC 20 [%] MSW	L1-N	Measurement of the Phase - Neutral voltage of the i-th harmonic in comparison with the fundamental [%]	RO	FLOAT32
40958	957	VTRUE RMS HARMONIC 20 [%] LSW			RO	
40959	958	VTRUE RMS HARMONIC 20 [%] MSW	L2-N	Measurement of the Phase - Neutral voltage of the i-th harmonic in comparison with the fundamental [%]	RO	FLOAT32
40960	959	VTRUE RMS HARMONIC 20 [%] LSW			RO	
40961	960	VTRUE RMS HARMONIC 20 [%] MSW	L3-N	Measurement of the Phase - Neutral voltage of the i-th harmonic in	RO	FLOAT32
40962	961	VTRUE RMS HARMONIC 20 [%] LSW			RO	

ADDRESS (4x)	ADDRESS OFFSET	REGISTER	PHASE	DESCRIPTION	W/R	TYPE
				comparison with the fundamental [%]		
40963	962	VTRUE RMS HARMONIC 21 [%] MSW	L1-N	Measurement of the Phase - Neutral voltage of the i-th harmonic in comparison with the fundamental [%]	RO	FLOAT32
40964	963	VTRUE RMS HARMONIC 21 [%] LSW			RO	
40965	964	VTRUE RMS HARMONIC 21 [%] MSW	L2-N	Measurement of the Phase - Neutral voltage of the i-th harmonic in comparison with the fundamental [%]	RO	FLOAT32
40966	965	VTRUE RMS HARMONIC 21 [%] LSW			RO	
40967	966	VTRUE RMS HARMONIC 21 [%] MSW	L3-N	Measurement of the Phase - Neutral voltage of the i-th harmonic in comparison with the fundamental [%]	RO	FLOAT32
40968	967	VTRUE RMS HARMONIC 21 [%] LSW			RO	
40969	968	VTRUE RMS HARMONIC 22 [%] MSW	L1-N	Measurement of the Phase - Neutral voltage of the i-th harmonic in comparison with the fundamental [%]	RO	FLOAT32
40970	969	VTRUE RMS HARMONIC 22 [%] LSW			RO	
40971	970	VTRUE RMS HARMONIC 22 [%] MSW	L2-N	Measurement of the Phase - Neutral voltage of the i-th harmonic in comparison with the fundamental [%]	RO	FLOAT32
40972	971	VTRUE RMS HARMONIC 22 [%] LSW			RO	
40973	972	VTRUE RMS HARMONIC 22 [%] MSW	L3-N	Measurement of the Phase - Neutral voltage of the i-th harmonic in comparison with	RO	FLOAT32
40974	973	VTRUE RMS HARMONIC 22 [%] LSW			RO	

ADDRESS (4x)	ADDRESS OFFSET	REGISTER	PHASE	DESCRIPTION	W/R	TYPE
				the fundamental [%]		
40975	974	VTRUE RMS HARMONIC 23 [%] MSW	L1-N	Measurement of the Phase - Neutral voltage of the i-th harmonic in comparison with the fundamental [%]	RO	FLOAT32
40976	975	VTRUE RMS HARMONIC 23 [%] LSW			RO	
40977	976	VTRUE RMS HARMONIC 23 [%] MSW	L2-N	Measurement of the Phase - Neutral voltage of the i-th harmonic in comparison with the fundamental [%]	RO	FLOAT32
40978	977	VTRUE RMS HARMONIC 23 [%] LSW			RO	
40979	978	VTRUE RMS HARMONIC 23 [%] MSW	L3-N	Measurement of the Phase - Neutral voltage of the i-th harmonic in comparison with the fundamental [%]	RO	FLOAT32
40980	979	VTRUE RMS HARMONIC 23 [%] LSW			RO	
40981	980	VTRUE RMS HARMONIC 24 [%] MSW	L1-N	Measurement of the Phase - Neutral voltage of the i-th harmonic in comparison with the fundamental [%]	RO	FLOAT32
40982	981	VTRUE RMS HARMONIC 24 [%] LSW			RO	
40983	982	VTRUE RMS HARMONIC 24 [%] MSW	L2-N	Measurement of the Phase - Neutral voltage of the i-th harmonic in comparison with the fundamental [%]	RO	FLOAT32
40984	983	VTRUE RMS HARMONIC 24 [%] LSW			RO	
40985	984	VTRUE RMS HARMONIC 24 [%] MSW	L3-N	Measurement of the Phase - Neutral voltage of the i-th harmonic in comparison with the fundamental [%]	RO	FLOAT32
40986	985	VTRUE RMS HARMONIC 24 [%] LSW			RO	

ADDRESS (4x)	ADDRESS OFFSET	REGISTER	PHASE	DESCRIPTION	W/R	TYPE
40987	986	VTRUE RMS HARMONIC 25 [%] MSW	L1-N	Measurement of the Phase - Neutral voltage of the i-th harmonic in comparison with the fundamental [%]	RO	FLOAT32
40988	987	VTRUE RMS HARMONIC 25 [%] LSW			RO	
40989	988	VTRUE RMS HARMONIC 25 [%] MSW	L2-N	Measurement of the Phase - Neutral voltage of the i-th harmonic in comparison with the fundamental [%]	RO	FLOAT32
40990	989	VTRUE RMS HARMONIC 25 [%] LSW			RO	
40991	990	VTRUE RMS HARMONIC 25 [%] MSW	L3-N	Measurement of the Phase - Neutral voltage of the i-th harmonic in comparison with the fundamental [%]	RO	FLOAT32
40992	991	VTRUE RMS HARMONIC 25 [%] LSW			RO	
40993	992	VTRUE RMS HARMONIC 26 [%] MSW	L1-N	Measurement of the Phase - Neutral voltage of the i-th harmonic in comparison with the fundamental [%]	RO	FLOAT32
40994	993	VTRUE RMS HARMONIC 26 [%] LSW			RO	
40995	994	VTRUE RMS HARMONIC 26 [%] MSW	L2-N	Measurement of the Phase - Neutral voltage of the i-th harmonic in comparison with the fundamental [%]	RO	FLOAT32
40996	995	VTRUE RMS HARMONIC 26 [%] LSW			RO	
40997	996	VTRUE RMS HARMONIC 26 [%] MSW	L3-N	Measurement of the Phase - Neutral voltage of the i-th harmonic in comparison with the fundamental [%]	RO	FLOAT32
40998	997	VTRUE RMS HARMONIC 26 [%] LSW			RO	
40999	998	VTRUE RMS HARMONIC 27 [%] MSW	L1-N	Measurement of the Phase - Neutral	RO	FLOAT32
41000	999	VTRUE RMS HARMONIC 27 [%] LSW			RO	

ADDRESS (4x)	ADDRESS OFFSET	REGISTER	PHASE	DESCRIPTION	W/R	TYPE
				voltage of the i-th harmonic in comparison with the fundamental [%]		
41001	1000	VTRUE RMS HARMONIC 27 [%] MSW	L2-N	Measurement of the Phase - Neutral voltage of the i-th harmonic in comparison with the fundamental [%]	RO	FLOAT32
41002	1001	VTRUE RMS HARMONIC 27 [%] LSW			RO	
41003	1002	VTRUE RMS HARMONIC 27 [%] MSW	L3-N	Measurement of the Phase - Neutral voltage of the i-th harmonic in comparison with the fundamental [%]	RO	FLOAT32
41004	1003	VTRUE RMS HARMONIC 27 [%] LSW			RO	
41005	1004	VTRUE RMS HARMONIC 28 [%] MSW	L1-N	Measurement of the Phase - Neutral voltage of the i-th harmonic in comparison with the fundamental [%]	RO	FLOAT32
41006	1005	VTRUE RMS HARMONIC 28 [%] LSW			RO	
41007	1006	VTRUE RMS HARMONIC 28 [%] MSW	L2-N	Measurement of the Phase - Neutral voltage of the i-th harmonic in comparison with the fundamental [%]	RO	FLOAT32
41008	1007	VTRUE RMS HARMONIC 28 [%] LSW			RO	
41009	1008	VTRUE RMS HARMONIC 28 [%] MSW	L3-N	Measurement of the Phase - Neutral voltage of the i-th harmonic in comparison with the fundamental [%]	RO	FLOAT32
41010	1009	VTRUE RMS HARMONIC 28 [%] LSW			RO	
41011	1010	VTRUE RMS HARMONIC 29 [%] MSW	L1-N	Measurement of the Phase - Neutral voltage of the i-th harmonic in	RO	FLOAT32
41012	1011	VTRUE RMS HARMONIC 29 [%] LSW			RO	

ADDRESS (4x)	ADDRESS OFFSET	REGISTER	PHASE	DESCRIPTION	W/R	TYPE
				comparison with the fundamental [%]		
41013	1012	VTRUE RMS HARMONIC 29 [%] MSW	L2-N	Measurement of the Phase - Neutral voltage of the i-th harmonic in comparison with the fundamental [%]	RO	FLOAT32
41014	1013	VTRUE RMS HARMONIC 29 [%] LSW			RO	
41015	1014	VTRUE RMS HARMONIC 29 [%] MSW	L3-N	Measurement of the Phase - Neutral voltage of the i-th harmonic in comparison with the fundamental [%]	RO	FLOAT32
41016	1015	VTRUE RMS HARMONIC 29 [%] LSW			RO	
41017	1016	VTRUE RMS HARMONIC 30 [%] MSW	L1-N	Measurement of the Phase - Neutral voltage of the i-th harmonic in comparison with the fundamental [%]	RO	FLOAT32
41018	1017	VTRUE RMS HARMONIC 30 [%] LSW			RO	
41019	1018	VTRUE RMS HARMONIC 30 [%] MSW	L2-N	Measurement of the Phase - Neutral voltage of the i-th harmonic in comparison with the fundamental [%]	RO	FLOAT32
41020	1019	VTRUE RMS HARMONIC 30 [%] LSW			RO	
41021	1020	VTRUE RMS HARMONIC 30 [%] MSW	L3-N	Measurement of the Phase - Neutral voltage of the i-th harmonic in comparison with the fundamental [%]	RO	FLOAT32
41022	1021	VTRUE RMS HARMONIC 30 [%] LSW			RO	
41023	1022	VTRUE RMS HARMONIC 31 [%] MSW	L1-N	Measurement of the Phase - Neutral voltage of the i-th harmonic in comparison with	RO	FLOAT32
41024	1023	VTRUE RMS HARMONIC 31 [%] LSW			RO	

ADDRESS (4x)	ADDRESS OFFSET	REGISTER	PHASE	DESCRIPTION	W/R	TYPE
				the fundamental [%]		
41025	1024	VTRUE RMS HARMONIC 31 [%] MSW	L2-N	Measurement of the Phase - Neutral voltage of the i-th harmonic in comparison with the fundamental [%]	RO	FLOAT32
41026	1025	VTRUE RMS HARMONIC 31 [%] LSW			RO	
41027	1026	VTRUE RMS HARMONIC 31 [%] MSW	L3-N	Measurement of the Phase - Neutral voltage of the i-th harmonic in comparison with the fundamental [%]	RO	FLOAT32
41028	1027	VTRUE RMS HARMONIC 31 [%] LSW			RO	
41029	1028	VTRUE RMS HARMONIC 32 [%] MSW	L1-N	Measurement of the Phase - Neutral voltage of the i-th harmonic in comparison with the fundamental [%]	RO	FLOAT32
41030	1029	VTRUE RMS HARMONIC 32 [%] LSW			RO	
41031	1030	VTRUE RMS HARMONIC 32 [%] MSW	L2-N	Measurement of the Phase - Neutral voltage of the i-th harmonic in comparison with the fundamental [%]	RO	FLOAT32
41032	1031	VTRUE RMS HARMONIC 32 [%] LSW			RO	
41033	1032	VTRUE RMS HARMONIC 32 [%] MSW	L3-N	Measurement of the Phase - Neutral voltage of the i-th harmonic in comparison with the fundamental [%]	RO	FLOAT32
41034	1033	VTRUE RMS HARMONIC 32 [%] LSW			RO	
41035	1034	VTRUE RMS HARMONIC 33 [%] MSW	L1-N	Measurement of the Phase - Neutral voltage of the i-th harmonic in comparison with the fundamental [%]	RO	FLOAT32
41036	1035	VTRUE RMS HARMONIC 33 [%] LSW			RO	

ADDRESS (4x)	ADDRESS OFFSET	REGISTER	PHASE	DESCRIPTION	W/R	TYPE
41037	1036	VTRUE RMS HARMONIC 33 [%] MSW	L2-N	Measurement of the Phase - Neutral voltage of the i-th harmonic in comparison with the fundamental [%]	RO	FLOAT32
41038	1037	VTRUE RMS HARMONIC 33 [%] LSW			RO	
41039	1038	VTRUE RMS HARMONIC 33 [%] MSW	L3-N	Measurement of the Phase - Neutral voltage of the i-th harmonic in comparison with the fundamental [%]	RO	FLOAT32
41040	1039	VTRUE RMS HARMONIC 33 [%] LSW			RO	
41041	1040	VTRUE RMS HARMONIC 34 [%] MSW	L1-N	Measurement of the Phase - Neutral voltage of the i-th harmonic in comparison with the fundamental [%]	RO	FLOAT32
41042	1041	VTRUE RMS HARMONIC 34 [%] LSW			RO	
41043	1042	VTRUE RMS HARMONIC 34 [%] MSW	L2-N	Measurement of the Phase - Neutral voltage of the i-th harmonic in comparison with the fundamental [%]	RO	FLOAT32
41044	1043	VTRUE RMS HARMONIC 34 [%] LSW			RO	
41045	1044	VTRUE RMS HARMONIC 34 [%] MSW	L3-N	Measurement of the Phase - Neutral voltage of the i-th harmonic in comparison with the fundamental [%]	RO	FLOAT32
41046	1045	VTRUE RMS HARMONIC 34 [%] LSW			RO	
41047	1046	VTRUE RMS HARMONIC 35 [%] MSW	L1-N	Measurement of the Phase - Neutral voltage of the i-th harmonic in comparison with the fundamental [%]	RO	FLOAT32
41048	1047	VTRUE RMS HARMONIC 35 [%] LSW			RO	
41049	1048	VTRUE RMS HARMONIC 35 [%] MSW	L2-N	Measurement of the Phase - Neutral	RO	FLOAT32
41050	1049	VTRUE RMS HARMONIC 35 [%] LSW			RO	

ADDRESS (4x)	ADDRESS OFFSET	REGISTER	PHASE	DESCRIPTION	W/R	TYPE
				voltage of the i-th harmonic in comparison with the fundamental [%]		
41051	1050	VTRUE RMS HARMONIC 35 [%] MSW	L3-N	Measurement of the Phase - Neutral voltage of the i-th harmonic in comparison with the fundamental [%]	RO	FLOAT32
41052	1051	VTRUE RMS HARMONIC 35 [%] LSW			RO	
41053	1052	VTRUE RMS HARMONIC 36 [%] MSW	L1-N	Measurement of the Phase - Neutral voltage of the i-th harmonic in comparison with the fundamental [%]	RO	FLOAT32
41054	1053	VTRUE RMS HARMONIC 36 [%] LSW			RO	
41055	1054	VTRUE RMS HARMONIC 36 [%] MSW	L2-N	Measurement of the Phase - Neutral voltage of the i-th harmonic in comparison with the fundamental [%]	RO	FLOAT32
41056	1055	VTRUE RMS HARMONIC 36 [%] LSW			RO	
41057	1056	VTRUE RMS HARMONIC 36 [%] MSW	L3-N	Measurement of the Phase - Neutral voltage of the i-th harmonic in comparison with the fundamental [%]	RO	FLOAT32
41058	1057	VTRUE RMS HARMONIC 36 [%] LSW			RO	
41059	1058	VTRUE RMS HARMONIC 37 [%] MSW	L1-N	Measurement of the Phase - Neutral voltage of the i-th harmonic in comparison with the fundamental [%]	RO	FLOAT32
41060	1059	VTRUE RMS HARMONIC 37 [%] LSW			RO	
41061	1060	VTRUE RMS HARMONIC 37 [%] MSW	L2-N	Measurement of the Phase - Neutral voltage of the i-th harmonic in	RO	FLOAT32
41062	1061	VTRUE RMS HARMONIC 37 [%] LSW			RO	

ADDRESS (4x)	ADDRESS OFFSET	REGISTER	PHASE	DESCRIPTION	W/R	TYPE
				comparison with the fundamental [%]		
41063	1062	VTRUE RMS HARMONIC 37 [%] MSW	L3-N	Measurement of the Phase - Neutral voltage of the i-th harmonic in comparison with the fundamental [%]	RO	FLOAT32
41064	1063	VTRUE RMS HARMONIC 37 [%] LSW			RO	
41065	1064	VTRUE RMS HARMONIC 38 [%] MSW	L1-N	Measurement of the Phase - Neutral voltage of the i-th harmonic in comparison with the fundamental [%]	RO	FLOAT32
41066	1065	VTRUE RMS HARMONIC 38 [%] LSW			RO	
41067	1066	VTRUE RMS HARMONIC 38 [%] MSW	L2-N	Measurement of the Phase - Neutral voltage of the i-th harmonic in comparison with the fundamental [%]	RO	FLOAT32
41068	1067	VTRUE RMS HARMONIC 38 [%] LSW			RO	
41069	1068	VTRUE RMS HARMONIC 38 [%] MSW	L3-N	Measurement of the Phase - Neutral voltage of the i-th harmonic in comparison with the fundamental [%]	RO	FLOAT32
41070	1069	VTRUE RMS HARMONIC 38 [%] LSW			RO	
41071	1070	VTRUE RMS HARMONIC 39 [%] MSW	L1-N	Measurement of the Phase - Neutral voltage of the i-th harmonic in comparison with the fundamental [%]	RO	FLOAT32
41072	1071	VTRUE RMS HARMONIC 39 [%] LSW			RO	
41073	1072	VTRUE RMS HARMONIC 39 [%] MSW	L2-N	Measurement of the Phase - Neutral voltage of the i-th harmonic in comparison with	RO	FLOAT32
41074	1073	VTRUE RMS HARMONIC 39 [%] LSW			RO	

ADDRESS (4x)	ADDRESS OFFSET	REGISTER	PHASE	DESCRIPTION	W/R	TYPE
				the fundamental [%]		
41075	1074	VTRUE RMS HARMONIC 39 [%] MSW	L3-N	Measurement of the Phase - Neutral voltage of the i-th harmonic in comparison with the fundamental [%]	RO	FLOAT32
41076	1075	VTRUE RMS HARMONIC 39 [%] LSW			RO	
41077	1076	VTRUE RMS HARMONIC 40 [%] MSW	L1-N	Measurement of the Phase - Neutral voltage of the i-th harmonic in comparison with the fundamental [%]	RO	FLOAT32
41078	1077	VTRUE RMS HARMONIC 40 [%] LSW			RO	
41079	1078	VTRUE RMS HARMONIC 40 [%] MSW	L2-N	Measurement of the Phase - Neutral voltage of the i-th harmonic in comparison with the fundamental [%]	RO	FLOAT32
41080	1079	VTRUE RMS HARMONIC 40 [%] LSW			RO	
41081	1080	VTRUE RMS HARMONIC 40 [%] MSW	L3-N	Measurement of the Phase - Neutral voltage of the i-th harmonic in comparison with the fundamental [%]	RO	FLOAT32
41082	1081	VTRUE RMS HARMONIC 40 [%] LSW			RO	
41083	1082	VTRUE RMS HARMONIC 41 [%] MSW	L1-N	Measurement of the Phase - Neutral voltage of the i-th harmonic in comparison with the fundamental [%]	RO	FLOAT32
41084	1083	VTRUE RMS HARMONIC 41 [%] LSW			RO	
41085	1084	VTRUE RMS HARMONIC 41 [%] MSW	L2-N	Measurement of the Phase - Neutral voltage of the i-th harmonic in comparison with the fundamental [%]	RO	FLOAT32
41086	1085	VTRUE RMS HARMONIC 41 [%] LSW			RO	

ADDRESS (4x)	ADDRESS OFFSET	REGISTER	PHASE	DESCRIPTION	W/R	TYPE
41087	1086	VTRUE RMS HARMONIC 41 [%] MSW	L3-N	Measurement of the Phase - Neutral voltage of the i-th harmonic in comparison with the fundamental [%]	RO	FLOAT32
41088	1087	VTRUE RMS HARMONIC 41 [%] LSW			RO	
41089	1088	VTRUE RMS HARMONIC 42 [%] MSW	L1-N	Measurement of the Phase - Neutral voltage of the i-th harmonic in comparison with the fundamental [%]	RO	FLOAT32
41090	1089	VTRUE RMS HARMONIC 42 [%] LSW			RO	
41091	1090	VTRUE RMS HARMONIC 42 [%] MSW	L2-N	Measurement of the Phase - Neutral voltage of the i-th harmonic in comparison with the fundamental [%]	RO	FLOAT32
41092	1091	VTRUE RMS HARMONIC 42 [%] LSW			RO	
41093	1092	VTRUE RMS HARMONIC 42 [%] MSW	L3-N	Measurement of the Phase - Neutral voltage of the i-th harmonic in comparison with the fundamental [%]	RO	FLOAT32
41094	1093	VTRUE RMS HARMONIC 42 [%] LSW			RO	
41095	1094	VTRUE RMS HARMONIC 43 [%] MSW	L1-N	Measurement of the Phase - Neutral voltage of the i-th harmonic in comparison with the fundamental [%]	RO	FLOAT32
41096	1095	VTRUE RMS HARMONIC 43 [%] LSW			RO	
41097	1096	VTRUE RMS HARMONIC 43 [%] MSW	L2-N	Measurement of the Phase - Neutral voltage of the i-th harmonic in comparison with the fundamental [%]	RO	FLOAT32
41098	1097	VTRUE RMS HARMONIC 43 [%] LSW			RO	
41099	1098	VTRUE RMS HARMONIC 43 [%] MSW	L3-N	Measurement of the Phase - Neutral	RO	FLOAT32
41100	1099	VTRUE RMS HARMONIC 43 [%] LSW			RO	

ADDRESS (4x)	ADDRESS OFFSET	REGISTER	PHASE	DESCRIPTION	W/R	TYPE
				voltage of the i-th harmonic in comparison with the fundamental [%]		
41101	1100	VTRUE RMS HARMONIC 44 [%] MSW	L1-N	Measurement of the Phase - Neutral voltage of the i-th harmonic in comparison with the fundamental [%]	RO	FLOAT32
41102	1101	VTRUE RMS HARMONIC 44 [%] LSW			RO	
41103	1102	VTRUE RMS HARMONIC 44 [%] MSW	L2-N	Measurement of the Phase - Neutral voltage of the i-th harmonic in comparison with the fundamental [%]	RO	FLOAT32
41104	1103	VTRUE RMS HARMONIC 44 [%] LSW			RO	
41105	1104	VTRUE RMS HARMONIC 44 [%] MSW	L3-N	Measurement of the Phase - Neutral voltage of the i-th harmonic in comparison with the fundamental [%]	RO	FLOAT32
41106	1105	VTRUE RMS HARMONIC 44 [%] LSW			RO	
41107	1106	VTRUE RMS HARMONIC 45 [%] MSW	L1-N	Measurement of the Phase - Neutral voltage of the i-th harmonic in comparison with the fundamental [%]	RO	FLOAT32
41108	1107	VTRUE RMS HARMONIC 45 [%] LSW			RO	
41109	1108	VTRUE RMS HARMONIC 45 [%] MSW	L2-N	Measurement of the Phase - Neutral voltage of the i-th harmonic in comparison with the fundamental [%]	RO	FLOAT32
41110	1109	VTRUE RMS HARMONIC 45 [%] LSW			RO	
41111	1110	VTRUE RMS HARMONIC 45 [%] MSW	L3-N	Measurement of the Phase - Neutral voltage of the i-th harmonic in	RO	FLOAT32
41112	1111	VTRUE RMS HARMONIC 45 [%] LSW			RO	

ADDRESS (4x)	ADDRESS OFFSET	REGISTER	PHASE	DESCRIPTION	W/R	TYPE
				comparison with the fundamental [%]		
41113	1112	VTRUE RMS HARMONIC 46 [%] MSW	L1-N	Measurement of the Phase - Neutral voltage of the i-th harmonic in comparison with the fundamental [%]	RO	FLOAT32
41114	1113	VTRUE RMS HARMONIC 46 [%] LSW			RO	
41115	1114	VTRUE RMS HARMONIC 46 [%] MSW	L2-N	Measurement of the Phase - Neutral voltage of the i-th harmonic in comparison with the fundamental [%]	RO	FLOAT32
41116	1115	VTRUE RMS HARMONIC 46 [%] LSW			RO	
41117	1116	VTRUE RMS HARMONIC 46 [%] MSW	L3-N	Measurement of the Phase - Neutral voltage of the i-th harmonic in comparison with the fundamental [%]	RO	FLOAT32
41118	1117	VTRUE RMS HARMONIC 46 [%] LSW			RO	
41119	1118	VTRUE RMS HARMONIC 47 [%] MSW	L1-N	Measurement of the Phase - Neutral voltage of the i-th harmonic in comparison with the fundamental [%]	RO	FLOAT32
41120	1119	VTRUE RMS HARMONIC 47 [%] LSW			RO	
41121	1120	VTRUE RMS HARMONIC 47 [%] MSW	L2-N	Measurement of the Phase - Neutral voltage of the i-th harmonic in comparison with the fundamental [%]	RO	FLOAT32
41122	1121	VTRUE RMS HARMONIC 47 [%] LSW			RO	
41123	1122	VTRUE RMS HARMONIC 47 [%] MSW	L3-N	Measurement of the Phase - Neutral voltage of the i-th harmonic in comparison with	RO	FLOAT32
41124	1123	VTRUE RMS HARMONIC 47 [%] LSW			RO	

ADDRESS (4x)	ADDRESS OFFSET	REGISTER	PHASE	DESCRIPTION	W/R	TYPE
				the fundamental [%]		
41125	1124	VTRUE RMS HARMONIC 48 [%] MSW	L1-N	Measurement of the Phase - Neutral voltage of the i-th harmonic in comparison with the fundamental [%]	RO	FLOAT32
41126	1125	VTRUE RMS HARMONIC 48 [%] LSW			RO	
41127	1126	VTRUE RMS HARMONIC 48 [%] MSW	L2-N	Measurement of the Phase - Neutral voltage of the i-th harmonic in comparison with the fundamental [%]	RO	FLOAT32
41128	1127	VTRUE RMS HARMONIC 48 [%] LSW			RO	
41129	1128	VTRUE RMS HARMONIC 48 [%] MSW	L3-N	Measurement of the Phase - Neutral voltage of the i-th harmonic in comparison with the fundamental [%]	RO	FLOAT32
41130	1129	VTRUE RMS HARMONIC 48 [%] LSW			RO	
41131	1130	VTRUE RMS HARMONIC 49 [%] MSW	L1-N	Measurement of the Phase - Neutral voltage of the i-th harmonic in comparison with the fundamental [%]	RO	FLOAT32
41132	1131	VTRUE RMS HARMONIC 49 [%] LSW			RO	
41133	1132	VTRUE RMS HARMONIC 49 [%] MSW	L2-N	Measurement of the Phase - Neutral voltage of the i-th harmonic in comparison with the fundamental [%]	RO	FLOAT32
41134	1133	VTRUE RMS HARMONIC 49 [%] LSW			RO	
41135	1134	VTRUE RMS HARMONIC 49 [%] MSW	L3-N	Measurement of the Phase - Neutral voltage of the i-th harmonic in comparison with the fundamental [%]	RO	FLOAT32
41136	1135	VTRUE RMS HARMONIC 49 [%] LSW			RO	

ADDRESS (4x)	ADDRESS OFFSET	REGISTER	PHASE	DESCRIPTION	W/R	TYPE
41137	1136	VTRUE RMS HARMONIC 50 [%] MSW	L1-N	Measurement of the Phase - Neutral voltage of the i-th harmonic in comparison with the fundamental [%]	RO	FLOAT32
41138	1137	VTRUE RMS HARMONIC 50 [%] LSW			RO	
41139	1138	VTRUE RMS HARMONIC 50 [%] MSW	L2-N	Measurement of the Phase - Neutral voltage of the i-th harmonic in comparison with the fundamental [%]	RO	FLOAT32
41140	1139	VTRUE RMS HARMONIC 50 [%] LSW			RO	
41141	1140	VTRUE RMS HARMONIC 50 [%] MSW	L3-N	Measurement of the Phase - Neutral voltage of the i-th harmonic in comparison with the fundamental [%]	RO	FLOAT32
41142	1141	VTRUE RMS HARMONIC 50 [%] LSW			RO	
41143	1142	VTRUE RMS HARMONIC 51 [%] MSW	L1-N	Measurement of the Phase - Neutral voltage of the i-th harmonic in comparison with the fundamental [%]	RO	FLOAT32
41144	1143	VTRUE RMS HARMONIC 51 [%] LSW			RO	
41145	1144	VTRUE RMS HARMONIC 51 [%] MSW	L2-N	Measurement of the Phase - Neutral voltage of the i-th harmonic in comparison with the fundamental [%]	RO	FLOAT32
41146	1145	VTRUE RMS HARMONIC 51 [%] LSW			RO	
41147	1146	VTRUE RMS HARMONIC 51 [%] MSW	L3-N	Measurement of the Phase - Neutral voltage of the i-th harmonic in comparison with the fundamental [%]	RO	FLOAT32
41148	1147	VTRUE RMS HARMONIC 51 [%] LSW			RO	
41149	1148	VTRUE RMS HARMONIC 52 [%] MSW	L1-N	Measurement of the Phase - Neutral	RO	FLOAT32
41150	1149	VTRUE RMS HARMONIC 52 [%] LSW			RO	

ADDRESS (4x)	ADDRESS OFFSET	REGISTER	PHASE	DESCRIPTION	W/R	TYPE
				voltage of the i-th harmonic in comparison with the fundamental [%]		
41151	1150	VTRUE RMS HARMONIC 52 [%] MSW	L2-N	Measurement of the Phase - Neutral voltage of the i-th harmonic in comparison with the fundamental [%]	RO	FLOAT32
41152	1151	VTRUE RMS HARMONIC 52 [%] LSW			RO	
41153	1152	VTRUE RMS HARMONIC 52 [%] MSW	L3-N	Measurement of the Phase - Neutral voltage of the i-th harmonic in comparison with the fundamental [%]	RO	FLOAT32
41154	1153	VTRUE RMS HARMONIC 52 [%] LSW			RO	
41155	1154	VTRUE RMS HARMONIC 53 [%] MSW	L1-N	Measurement of the Phase - Neutral voltage of the i-th harmonic in comparison with the fundamental [%]	RO	FLOAT32
41156	1155	VTRUE RMS HARMONIC 53 [%] LSW			RO	
41157	1156	VTRUE RMS HARMONIC 53 [%] MSW	L2-N	Measurement of the Phase - Neutral voltage of the i-th harmonic in comparison with the fundamental [%]	RO	FLOAT32
41158	1157	VTRUE RMS HARMONIC 53 [%] LSW			RO	
41159	1158	VTRUE RMS HARMONIC 53 [%] MSW	L3-N	Measurement of the Phase - Neutral voltage of the i-th harmonic in comparison with the fundamental [%]	RO	FLOAT32
41160	1159	VTRUE RMS HARMONIC 53 [%] LSW			RO	
41161	1160	VTRUE RMS HARMONIC 54 [%] MSW	L1-N	Measurement of the Phase - Neutral voltage of the i-th harmonic in	RO	FLOAT32
41162	1161	VTRUE RMS HARMONIC 54 [%] LSW			RO	

ADDRESS (4x)	ADDRESS OFFSET	REGISTER	PHASE	DESCRIPTION	W/R	TYPE
				comparison with the fundamental [%]		
41163	1162	VTRUE RMS HARMONIC 54 [%] MSW	L2-N	Measurement of the Phase - Neutral voltage of the i-th harmonic in comparison with the fundamental [%]	RO	FLOAT32
41164	1163	VTRUE RMS HARMONIC 54 [%] LSW			RO	
41165	1164	VTRUE RMS HARMONIC 54 [%] MSW	L3-N	Measurement of the Phase - Neutral voltage of the i-th harmonic in comparison with the fundamental [%]	RO	FLOAT32
41166	1165	VTRUE RMS HARMONIC 54 [%] LSW			RO	
41167	1166	VTRUE RMS HARMONIC 55 [%] MSW	L1-N	Measurement of the Phase - Neutral voltage of the i-th harmonic in comparison with the fundamental [%]	RO	FLOAT32
41168	1167	VTRUE RMS HARMONIC 55 [%] LSW			RO	
41169	1168	VTRUE RMS HARMONIC 55 [%] MSW	L2-N	Measurement of the Phase - Neutral voltage of the i-th harmonic in comparison with the fundamental [%]	RO	FLOAT32
41170	1169	VTRUE RMS HARMONIC 55 [%] LSW			RO	
41171	1170	VTRUE RMS HARMONIC 55 [%] MSW	L3-N	Measurement of the Phase - Neutral voltage of the i-th harmonic in comparison with the fundamental [%]	RO	FLOAT32
41172	1171	VTRUE RMS HARMONIC 55 [%] LSW			RO	
41173	1172	ITRUE RMS HARMONIC 2 [%] MSW	L1	Measurement of the Phase - Neutral current of the i-th harmonic in comparison with the fundamental [%]	RO	FLOAT32
41174	1173	ITRUE RMS HARMONIC 2 [%] LSW			RO	

ADDRESS (4x)	ADDRESS OFFSET	REGISTER	PHASE	DESCRIPTION	W/R	TYPE
41175	1174	ITRUE RMS HARMONIC 2 [%] MSW	L2	Measurement of the Phase - Neutral current of the i-th harmonic in comparison with the fundamental [%]	RO	FLOAT32
41176	1175	ITRUE RMS HARMONIC 2 [%] LSW			RO	
41177	1176	ITRUE RMS HARMONIC 2 [%] MSW	L3	Measurement of the Phase - Neutral current of the i-th harmonic in comparison with the fundamental [%]	RO	FLOAT32
41178	1177	ITRUE RMS HARMONIC 2 [%] LSW			RO	
41179	1178	ITRUE RMS HARMONIC 3 [%] MSW	L1	Measurement of the Phase - Neutral current of the i-th harmonic in comparison with the fundamental [%]	RO	FLOAT32
41180	1179	ITRUE RMS HARMONIC 3 [%] LSW			RO	
41181	1180	ITRUE RMS HARMONIC 3 [%] MSW	L2	Measurement of the Phase - Neutral current of the i-th harmonic in comparison with the fundamental [%]	RO	FLOAT32
41182	1181	ITRUE RMS HARMONIC 3 [%] LSW			RO	
41183	1182	ITRUE RMS HARMONIC 3 [%] MSW	L3	Measurement of the Phase - Neutral current of the i-th harmonic in comparison with the fundamental [%]	RO	FLOAT32
41184	1183	ITRUE RMS HARMONIC 3 [%] LSW			RO	
41185	1184	ITRUE RMS HARMONIC 4 [%] MSW	L1	Measurement of the Phase - Neutral current of the i-th harmonic in comparison with the fundamental [%]	RO	FLOAT32
41186	1185	ITRUE RMS HARMONIC 4 [%] LSW			RO	
41187	1186	ITRUE RMS HARMONIC 4 [%] MSW	L2	Measurement of the Phase - Neutral	RO	FLOAT32
41188	1187	ITRUE RMS HARMONIC 4 [%] LSW			RO	

ADDRESS (4x)	ADDRESS OFFSET	REGISTER	PHASE	DESCRIPTION	W/R	TYPE
				current of the i-th harmonic in comparison with the fundamental [%]		
41189	1188	ITRUE RMS HARMONIC 4 [%] MSW	L3	Measurement of the Phase - Neutral current of the i-th harmonic in comparison with the fundamental [%]	RO	FLOAT32
41190	1189	ITRUE RMS HARMONIC 4 [%] LSW			RO	
41191	1190	ITRUE RMS HARMONIC 5 [%] MSW	L1	Measurement of the Phase - Neutral current of the i-th harmonic in comparison with the fundamental [%]	RO	FLOAT32
41192	1191	ITRUE RMS HARMONIC 5 [%] LSW			RO	
41193	1192	ITRUE RMS HARMONIC 5 [%] MSW	L2	Measurement of the Phase - Neutral current of the i-th harmonic in comparison with the fundamental [%]	RO	FLOAT32
41194	1193	ITRUE RMS HARMONIC 5 [%] LSW			RO	
41195	1194	ITRUE RMS HARMONIC 5 [%] MSW	L3	Measurement of the Phase - Neutral current of the i-th harmonic in comparison with the fundamental [%]	RO	FLOAT32
41196	1195	ITRUE RMS HARMONIC 5 [%] LSW			RO	
41197	1196	ITRUE RMS HARMONIC 6 [%] MSW	L1	Measurement of the Phase - Neutral current of the i-th harmonic in comparison with the fundamental [%]	RO	FLOAT32
41198	1197	ITRUE RMS HARMONIC 6 [%] LSW			RO	
41199	1198	ITRUE RMS HARMONIC 6 [%] MSW	L2	Measurement of the Phase - Neutral current of the i-th harmonic in	RO	FLOAT32
41200	1199	ITRUE RMS HARMONIC 6 [%] LSW			RO	

ADDRESS (4x)	ADDRESS OFFSET	REGISTER	PHASE	DESCRIPTION	W/R	TYPE
				comparison with the fundamental [%]		
41201	1200	ITRUE RMS HARMONIC 6 [%] MSW	L3	Measurement of the Phase - Neutral current of the i-th harmonic in comparison with the fundamental [%]	RO	FLOAT32
41202	1201	ITRUE RMS HARMONIC 6 [%] LSW			RO	
41203	1202	ITRUE RMS HARMONIC 7 [%] MSW	L1	Measurement of the Phase - Neutral current of the i-th harmonic in comparison with the fundamental [%]	RO	FLOAT32
41204	1203	ITRUE RMS HARMONIC 7 [%] LSW			RO	
41205	1204	ITRUE RMS HARMONIC 7 [%] MSW	L2	Measurement of the Phase - Neutral current of the i-th harmonic in comparison with the fundamental [%]	RO	FLOAT32
41206	1205	ITRUE RMS HARMONIC 7 [%] LSW			RO	
41207	1206	ITRUE RMS HARMONIC 7 [%] MSW	L3	Measurement of the Phase - Neutral current of the i-th harmonic in comparison with the fundamental [%]	RO	FLOAT32
41208	1207	ITRUE RMS HARMONIC 7 [%] LSW			RO	
41209	1208	ITRUE RMS HARMONIC 8 [%] MSW	L1	Measurement of the Phase - Neutral current of the i-th harmonic in comparison with the fundamental [%]	RO	FLOAT32
41210	1209	ITRUE RMS HARMONIC 8 [%] LSW			RO	
41211	1210	ITRUE RMS HARMONIC 8 [%] MSW	L2	Measurement of the Phase - Neutral current of the i-th harmonic in comparison with	RO	FLOAT32
41212	1211	ITRUE RMS HARMONIC 8 [%] LSW			RO	

ADDRESS (4x)	ADDRESS OFFSET	REGISTER	PHASE	DESCRIPTION	W/R	TYPE
				the fundamental [%]		
41213	1212	ITRUE RMS HARMONIC 8 [%] MSW	L3	Measurement of the Phase - Neutral current of the i-th harmonic in comparison with the fundamental [%]	RO	FLOAT32
41214	1213	ITRUE RMS HARMONIC 8 [%] LSW			RO	
41215	1214	ITRUE RMS HARMONIC 9 [%] MSW	L1	Measurement of the Phase - Neutral current of the i-th harmonic in comparison with the fundamental [%]	RO	FLOAT32
41216	1215	ITRUE RMS HARMONIC 9 [%] LSW			RO	
41217	1216	ITRUE RMS HARMONIC 9 [%] MSW	L2	Measurement of the Phase - Neutral current of the i-th harmonic in comparison with the fundamental [%]	RO	FLOAT32
41218	1217	ITRUE RMS HARMONIC 9 [%] LSW			RO	
41219	1218	ITRUE RMS HARMONIC 9 [%] MSW	L3	Measurement of the Phase - Neutral current of the i-th harmonic in comparison with the fundamental [%]	RO	FLOAT32
41220	1219	ITRUE RMS HARMONIC 9 [%] LSW			RO	
41221	1220	ITRUE RMS HARMONIC 10 [%] MSW	L1	Measurement of the Phase - Neutral current of the i-th harmonic in comparison with the fundamental [%]	RO	FLOAT32
41222	1221	ITRUE RMS HARMONIC 10 [%] LSW			RO	
41223	1222	ITRUE RMS HARMONIC 10 [%] MSW	L2	Measurement of the Phase - Neutral current of the i-th harmonic in comparison with the fundamental [%]	RO	FLOAT32
41224	1223	ITRUE RMS HARMONIC 10 [%] LSW			RO	

ADDRESS (4x)	ADDRESS OFFSET	REGISTER	PHASE	DESCRIPTION	W/R	TYPE
41225	1224	ITRUE RMS HARMONIC 10 [%] MSW	L3	Measurement of the Phase - Neutral current of the i-th harmonic in comparison with the fundamental [%]	RO	FLOAT32
41226	1225	ITRUE RMS HARMONIC 10 [%] LSW			RO	
41227	1226	ITRUE RMS HARMONIC 11 [%] MSW	L1	Measurement of the Phase - Neutral current of the i-th harmonic in comparison with the fundamental [%]	RO	FLOAT32
41228	1227	ITRUE RMS HARMONIC 11 [%] LSW			RO	
41229	1228	ITRUE RMS HARMONIC 11 [%] MSW	L2	Measurement of the Phase - Neutral current of the i-th harmonic in comparison with the fundamental [%]	RO	FLOAT32
41230	1229	ITRUE RMS HARMONIC 11 [%] LSW			RO	
41231	1230	ITRUE RMS HARMONIC 11 [%] MSW	L3	Measurement of the Phase - Neutral current of the i-th harmonic in comparison with the fundamental [%]	RO	FLOAT32
41232	1231	ITRUE RMS HARMONIC 11 [%] LSW			RO	
41233	1232	ITRUE RMS HARMONIC 12 [%] MSW	L1	Measurement of the Phase - Neutral current of the i-th harmonic in comparison with the fundamental [%]	RO	FLOAT32
41234	1233	ITRUE RMS HARMONIC 12 [%] LSW			RO	
41235	1234	ITRUE RMS HARMONIC 12 [%] MSW	L2	Measurement of the Phase - Neutral current of the i-th harmonic in comparison with the fundamental [%]	RO	FLOAT32
41236	1235	ITRUE RMS HARMONIC 12 [%] LSW			RO	
41237	1236	ITRUE RMS HARMONIC 12 [%] MSW	L3	Measurement of the Phase - Neutral	RO	FLOAT32
41238	1237	ITRUE RMS HARMONIC 12 [%] LSW			RO	

ADDRESS (4x)	ADDRESS OFFSET	REGISTER	PHASE	DESCRIPTION	W/R	TYPE
				current of the i-th harmonic in comparison with the fundamental [%]		
41239	1238	ITRUE RMS HARMONIC 13 [%] MSW	L1	Measurement of the Phase - Neutral current of the i-th harmonic in comparison with the fundamental [%]	RO	FLOAT32
41240	1239	ITRUE RMS HARMONIC 13 [%] LSW			RO	
41241	1240	ITRUE RMS HARMONIC 13 [%] MSW	L2	Measurement of the Phase - Neutral current of the i-th harmonic in comparison with the fundamental [%]	RO	FLOAT32
41242	1241	ITRUE RMS HARMONIC 13 [%] LSW			RO	
41243	1242	ITRUE RMS HARMONIC 13 [%] MSW	L3	Measurement of the Phase - Neutral current of the i-th harmonic in comparison with the fundamental [%]	RO	FLOAT32
41244	1243	ITRUE RMS HARMONIC 13 [%] LSW			RO	
41245	1244	ITRUE RMS HARMONIC 14 [%] MSW	L1	Measurement of the Phase - Neutral current of the i-th harmonic in comparison with the fundamental [%]	RO	FLOAT32
41246	1245	ITRUE RMS HARMONIC 14 [%] LSW			RO	
41247	1246	ITRUE RMS HARMONIC 14 [%] MSW	L2	Measurement of the Phase - Neutral current of the i-th harmonic in comparison with the fundamental [%]	RO	FLOAT32
41248	1247	ITRUE RMS HARMONIC 14 [%] LSW			RO	
41249	1248	ITRUE RMS HARMONIC 14 [%] MSW	L3	Measurement of the Phase - Neutral current of the i-th harmonic in	RO	FLOAT32
41250	1249	ITRUE RMS HARMONIC 14 [%] LSW			RO	

ADDRESS (4x)	ADDRESS OFFSET	REGISTER	PHASE	DESCRIPTION	W/R	TYPE
				comparison with the fundamental [%]		
41251	1250	ITRUE RMS HARMONIC 15 [%] MSW	L1	Measurement of the Phase - Neutral current of the i-th harmonic in comparison with the fundamental [%]	RO	FLOAT32
41252	1251	ITRUE RMS HARMONIC 15 [%] LSW			RO	
41253	1252	ITRUE RMS HARMONIC 15 [%] MSW	L2	Measurement of the Phase - Neutral current of the i-th harmonic in comparison with the fundamental [%]	RO	FLOAT32
41254	1253	ITRUE RMS HARMONIC 15 [%] LSW			RO	
41255	1254	ITRUE RMS HARMONIC 15 [%] MSW	L3	Measurement of the Phase - Neutral current of the i-th harmonic in comparison with the fundamental [%]	RO	FLOAT32
41256	1255	ITRUE RMS HARMONIC 15 [%] LSW			RO	
41257	1256	ITRUE RMS HARMONIC 16 [%] MSW	L1	Measurement of the Phase - Neutral current of the i-th harmonic in comparison with the fundamental [%]	RO	FLOAT32
41258	1257	ITRUE RMS HARMONIC 16 [%] LSW			RO	
41259	1258	ITRUE RMS HARMONIC 16 [%] MSW	L2	Measurement of the Phase - Neutral current of the i-th harmonic in comparison with the fundamental [%]	RO	FLOAT32
41260	1259	ITRUE RMS HARMONIC 16 [%] LSW			RO	
41261	1260	ITRUE RMS HARMONIC 16 [%] MSW	L3	Measurement of the Phase - Neutral current of the i-th harmonic in comparison with	RO	FLOAT32
41262	1261	ITRUE RMS HARMONIC 16 [%] LSW			RO	

ADDRESS (4x)	ADDRESS OFFSET	REGISTER	PHASE	DESCRIPTION	W/R	TYPE
				the fundamental [%]		
41263	1262	ITRUE RMS HARMONIC 17 [%] MSW	L1	Measurement of the Phase - Neutral current of the i-th harmonic in comparison with the fundamental [%]	RO	FLOAT32
41264	1263	ITRUE RMS HARMONIC 17 [%] LSW			RO	
41265	1264	ITRUE RMS HARMONIC 17 [%] MSW	L2	Measurement of the Phase - Neutral current of the i-th harmonic in comparison with the fundamental [%]	RO	FLOAT32
41266	1265	ITRUE RMS HARMONIC 17 [%] LSW			RO	
41267	1266	ITRUE RMS HARMONIC 17 [%] MSW	L3	Measurement of the Phase - Neutral current of the i-th harmonic in comparison with the fundamental [%]	RO	FLOAT32
41268	1267	ITRUE RMS HARMONIC 17 [%] LSW			RO	
41269	1268	ITRUE RMS HARMONIC 18 [%] MSW	L1	Measurement of the Phase - Neutral current of the i-th harmonic in comparison with the fundamental [%]	RO	FLOAT32
41270	1269	ITRUE RMS HARMONIC 18 [%] LSW			RO	
41271	1270	ITRUE RMS HARMONIC 18 [%] MSW	L2	Measurement of the Phase - Neutral current of the i-th harmonic in comparison with the fundamental [%]	RO	FLOAT32
41272	1271	ITRUE RMS HARMONIC 18 [%] LSW			RO	
41273	1272	ITRUE RMS HARMONIC 18 [%] MSW	L3	Measurement of the Phase - Neutral current of the i-th harmonic in comparison with the fundamental [%]	RO	FLOAT32
41274	1273	ITRUE RMS HARMONIC 18 [%] LSW			RO	

ADDRESS (4x)	ADDRESS OFFSET	REGISTER	PHASE	DESCRIPTION	W/R	TYPE
41275	1274	ITRUE RMS HARMONIC 19 [%] MSW	L1	Measurement of the Phase - Neutral current of the i-th harmonic in comparison with the fundamental [%]	RO	FLOAT32
41276	1275	ITRUE RMS HARMONIC 19 [%] LSW			RO	
41277	1276	ITRUE RMS HARMONIC 19 [%] MSW	L2	Measurement of the Phase - Neutral current of the i-th harmonic in comparison with the fundamental [%]	RO	FLOAT32
41278	1277	ITRUE RMS HARMONIC 19 [%] LSW			RO	
41279	1278	ITRUE RMS HARMONIC 19 [%] MSW	L3	Measurement of the Phase - Neutral current of the i-th harmonic in comparison with the fundamental [%]	RO	FLOAT32
41280	1279	ITRUE RMS HARMONIC 19 [%] LSW			RO	
41281	1280	ITRUE RMS HARMONIC 20 [%] MSW	L1	Measurement of the Phase - Neutral current of the i-th harmonic in comparison with the fundamental [%]	RO	FLOAT32
41282	1281	ITRUE RMS HARMONIC 20 [%] LSW			RO	
41283	1282	ITRUE RMS HARMONIC 20 [%] MSW	L2	Measurement of the Phase - Neutral current of the i-th harmonic in comparison with the fundamental [%]	RO	FLOAT32
41284	1283	ITRUE RMS HARMONIC 20 [%] LSW			RO	
41285	1284	ITRUE RMS HARMONIC 20 [%] MSW	L3	Measurement of the Phase - Neutral current of the i-th harmonic in comparison with the fundamental [%]	RO	FLOAT32
41286	1285	ITRUE RMS HARMONIC 20 [%] LSW			RO	
41287	1286	ITRUE RMS HARMONIC 21 [%] MSW	L1	Measurement of the Phase - Neutral	RO	FLOAT32
41288	1287	ITRUE RMS HARMONIC 21 [%] LSW			RO	

ADDRESS (4x)	ADDRESS OFFSET	REGISTER	PHASE	DESCRIPTION	W/R	TYPE
				current of the i-th harmonic in comparison with the fundamental [%]		
41289	1288	ITRUE RMS HARMONIC 21 [%] MSW	L2	Measurement of the Phase - Neutral current of the i-th harmonic in comparison with the fundamental [%]	RO	FLOAT32
41290	1289	ITRUE RMS HARMONIC 21 [%] LSW			RO	
41291	1290	ITRUE RMS HARMONIC 21 [%] MSW	L3	Measurement of the Phase - Neutral current of the i-th harmonic in comparison with the fundamental [%]	RO	FLOAT32
41292	1291	ITRUE RMS HARMONIC 21 [%] LSW			RO	
41293	1292	ITRUE RMS HARMONIC 22 [%] MSW	L1	Measurement of the Phase - Neutral current of the i-th harmonic in comparison with the fundamental [%]	RO	FLOAT32
41294	1293	ITRUE RMS HARMONIC 22 [%] LSW			RO	
41295	1294	ITRUE RMS HARMONIC 22 [%] MSW	L2	Measurement of the Phase - Neutral current of the i-th harmonic in comparison with the fundamental [%]	RO	FLOAT32
41296	1295	ITRUE RMS HARMONIC 22 [%] LSW			RO	
41297	1296	ITRUE RMS HARMONIC 22 [%] MSW	L3	Measurement of the Phase - Neutral current of the i-th harmonic in comparison with the fundamental [%]	RO	FLOAT32
41298	1297	ITRUE RMS HARMONIC 22 [%] LSW			RO	
41299	1298	ITRUE RMS HARMONIC 23 [%] MSW	L1	Measurement of the Phase - Neutral current of the i-th harmonic in	RO	FLOAT32
41300	1299	ITRUE RMS HARMONIC 23 [%] LSW			RO	

ADDRESS (4x)	ADDRESS OFFSET	REGISTER	PHASE	DESCRIPTION	W/R	TYPE
				comparison with the fundamental [%]		
41301	1300	ITRUE RMS HARMONIC 23 [%] MSW	L2	Measurement of the Phase - Neutral current of the i-th harmonic in comparison with the fundamental [%]	RO	FLOAT32
41302	1301	ITRUE RMS HARMONIC 23 [%] LSW			RO	
41303	1302	ITRUE RMS HARMONIC 23 [%] MSW	L3	Measurement of the Phase - Neutral current of the i-th harmonic in comparison with the fundamental [%]	RO	FLOAT32
41304	1303	ITRUE RMS HARMONIC 23 [%] LSW			RO	
41305	1304	ITRUE RMS HARMONIC 24 [%] MSW	L1	Measurement of the Phase - Neutral current of the i-th harmonic in comparison with the fundamental [%]	RO	FLOAT32
41306	1305	ITRUE RMS HARMONIC 24 [%] LSW			RO	
41307	1306	ITRUE RMS HARMONIC 24 [%] MSW	L2	Measurement of the Phase - Neutral current of the i-th harmonic in comparison with the fundamental [%]	RO	FLOAT32
41308	1307	ITRUE RMS HARMONIC 24 [%] LSW			RO	
41309	1308	ITRUE RMS HARMONIC 24 [%] MSW	L3	Measurement of the Phase - Neutral current of the i-th harmonic in comparison with the fundamental [%]	RO	FLOAT32
41310	1309	ITRUE RMS HARMONIC 24 [%] LSW			RO	
41311	1310	ITRUE RMS HARMONIC 25 [%] MSW	L1	Measurement of the Phase - Neutral current of the i-th harmonic in comparison with	RO	FLOAT32
41312	1311	ITRUE RMS HARMONIC 25 [%] LSW			RO	

ADDRESS (4x)	ADDRESS OFFSET	REGISTER	PHASE	DESCRIPTION	W/R	TYPE
				the fundamental [%]		
41313	1312	ITRUE RMS HARMONIC 25 [%] MSW	L2	Measurement of the Phase - Neutral current of the i-th harmonic in comparison with the fundamental [%]	RO	FLOAT32
41314	1313	ITRUE RMS HARMONIC 25 [%] LSW			RO	
41315	1314	ITRUE RMS HARMONIC 25 [%] MSW	L3	Measurement of the Phase - Neutral current of the i-th harmonic in comparison with the fundamental [%]	RO	FLOAT32
41316	1315	ITRUE RMS HARMONIC 25 [%] LSW			RO	
41317	1316	ITRUE RMS HARMONIC 26 [%] MSW	L1	Measurement of the Phase - Neutral current of the i-th harmonic in comparison with the fundamental [%]	RO	FLOAT32
41318	1317	ITRUE RMS HARMONIC 26 [%] LSW			RO	
41319	1318	ITRUE RMS HARMONIC 26 [%] MSW	L2	Measurement of the Phase - Neutral current of the i-th harmonic in comparison with the fundamental [%]	RO	FLOAT32
41320	1319	ITRUE RMS HARMONIC 26 [%] LSW			RO	
41321	1320	ITRUE RMS HARMONIC 26 [%] MSW	L3	Measurement of the Phase - Neutral current of the i-th harmonic in comparison with the fundamental [%]	RO	FLOAT32
41322	1321	ITRUE RMS HARMONIC 26 [%] LSW			RO	
41323	1322	ITRUE RMS HARMONIC 27 [%] MSW	L1	Measurement of the Phase - Neutral current of the i-th harmonic in comparison with the fundamental [%]	RO	FLOAT32
41324	1323	ITRUE RMS HARMONIC 27 [%] LSW			RO	

ADDRESS (4x)	ADDRESS OFFSET	REGISTER	PHASE	DESCRIPTION	W/R	TYPE
41325	1324	ITRUE RMS HARMONIC 27 [%] MSW	L2	Measurement of the Phase - Neutral current of the i-th harmonic in comparison with the fundamental [%]	RO	FLOAT32
41326	1325	ITRUE RMS HARMONIC 27 [%] LSW			RO	
41327	1326	ITRUE RMS HARMONIC 27 [%] MSW	L3	Measurement of the Phase - Neutral current of the i-th harmonic in comparison with the fundamental [%]	RO	FLOAT32
41328	1327	ITRUE RMS HARMONIC 27 [%] LSW			RO	
41329	1328	ITRUE RMS HARMONIC 28 [%] MSW	L1	Measurement of the Phase - Neutral current of the i-th harmonic in comparison with the fundamental [%]	RO	FLOAT32
41330	1329	ITRUE RMS HARMONIC 28 [%] LSW			RO	
41331	1330	ITRUE RMS HARMONIC 28 [%] MSW	L2	Measurement of the Phase - Neutral current of the i-th harmonic in comparison with the fundamental [%]	RO	FLOAT32
41332	1331	ITRUE RMS HARMONIC 28 [%] LSW			RO	
41333	1332	ITRUE RMS HARMONIC 28 [%] MSW	L3	Measurement of the Phase - Neutral current of the i-th harmonic in comparison with the fundamental [%]	RO	FLOAT32
41334	1333	ITRUE RMS HARMONIC 28 [%] LSW			RO	
41335	1334	ITRUE RMS HARMONIC 29 [%] MSW	L1	Measurement of the Phase - Neutral current of the i-th harmonic in comparison with the fundamental [%]	RO	FLOAT32
41336	1335	ITRUE RMS HARMONIC 29 [%] LSW			RO	
41337	1336	ITRUE RMS HARMONIC 29 [%] MSW	L2	Measurement of the Phase - Neutral	RO	FLOAT32
41338	1337	ITRUE RMS HARMONIC 29 [%] LSW			RO	

ADDRESS (4x)	ADDRESS OFFSET	REGISTER	PHASE	DESCRIPTION	W/R	TYPE
				current of the i-th harmonic in comparison with the fundamental [%]		
41339	1338	ITRUE RMS HARMONIC 29 [%] MSW	L3	Measurement of the Phase - Neutral current of the i-th harmonic in comparison with the fundamental [%]	RO	FLOAT32
41340	1339	ITRUE RMS HARMONIC 29 [%] LSW			RO	
41341	1340	ITRUE RMS HARMONIC 30 [%] MSW	L1	Measurement of the Phase - Neutral current of the i-th harmonic in comparison with the fundamental [%]	RO	FLOAT32
41342	1341	ITRUE RMS HARMONIC 30 [%] LSW			RO	
41343	1342	ITRUE RMS HARMONIC 30 [%] MSW	L2	Measurement of the Phase - Neutral current of the i-th harmonic in comparison with the fundamental [%]	RO	FLOAT32
41344	1343	ITRUE RMS HARMONIC 30 [%] LSW			RO	
41345	1344	ITRUE RMS HARMONIC 30 [%] MSW	L3	Measurement of the Phase - Neutral current of the i-th harmonic in comparison with the fundamental [%]	RO	FLOAT32
41346	1345	ITRUE RMS HARMONIC 30 [%] LSW			RO	
41347	1346	ITRUE RMS HARMONIC 31 [%] MSW	L1	Measurement of the Phase - Neutral current of the i-th harmonic in comparison with the fundamental [%]	RO	FLOAT32
41348	1347	ITRUE RMS HARMONIC 31 [%] LSW			RO	
41349	1348	ITRUE RMS HARMONIC 31 [%] MSW	L2	Measurement of the Phase - Neutral current of the i-th harmonic in	RO	FLOAT32
41350	1349	ITRUE RMS HARMONIC 31 [%] LSW			RO	

ADDRESS (4x)	ADDRESS OFFSET	REGISTER	PHASE	DESCRIPTION	W/R	TYPE
				comparison with the fundamental [%]		
41351	1350	ITRUE RMS HARMONIC 31 [%] MSW	L3	Measurement of the Phase - Neutral current of the i-th harmonic in comparison with the fundamental [%]	RO	FLOAT32
41352	1351	ITRUE RMS HARMONIC 31 [%] LSW			RO	
41353	1352	ITRUE RMS HARMONIC 32 [%] MSW	L1	Measurement of the Phase - Neutral current of the i-th harmonic in comparison with the fundamental [%]	RO	FLOAT32
41354	1353	ITRUE RMS HARMONIC 32 [%] LSW			RO	
41355	1354	ITRUE RMS HARMONIC 32 [%] MSW	L2	Measurement of the Phase - Neutral current of the i-th harmonic in comparison with the fundamental [%]	RO	FLOAT32
41356	1355	ITRUE RMS HARMONIC 32 [%] LSW			RO	
41357	1356	ITRUE RMS HARMONIC 32 [%] MSW	L3	Measurement of the Phase - Neutral current of the i-th harmonic in comparison with the fundamental [%]	RO	FLOAT32
41358	1357	ITRUE RMS HARMONIC 32 [%] LSW			RO	
41359	1358	ITRUE RMS HARMONIC 33 [%] MSW	L1	Measurement of the Phase - Neutral current of the i-th harmonic in comparison with the fundamental [%]	RO	FLOAT32
41360	1359	ITRUE RMS HARMONIC 33 [%] LSW			RO	
41361	1360	ITRUE RMS HARMONIC 33 [%] MSW	L2	Measurement of the Phase - Neutral current of the i-th harmonic in comparison with	RO	FLOAT32
41362	1361	ITRUE RMS HARMONIC 33 [%] LSW			RO	

ADDRESS (4x)	ADDRESS OFFSET	REGISTER	PHASE	DESCRIPTION	W/R	TYPE
				the fundamental [%]		
41363	1362	ITRUE RMS HARMONIC 33 [%] MSW	L3	Measurement of the Phase - Neutral current of the i-th harmonic in comparison with the fundamental [%]	RO	FLOAT32
41364	1363	ITRUE RMS HARMONIC 33 [%] LSW			RO	
41365	1364	ITRUE RMS HARMONIC 34 [%] MSW	L1	Measurement of the Phase - Neutral current of the i-th harmonic in comparison with the fundamental [%]	RO	FLOAT32
41366	1365	ITRUE RMS HARMONIC 34 [%] LSW			RO	
41367	1366	ITRUE RMS HARMONIC 34 [%] MSW	L2	Measurement of the Phase - Neutral current of the i-th harmonic in comparison with the fundamental [%]	RO	FLOAT32
41368	1367	ITRUE RMS HARMONIC 34 [%] LSW			RO	
41369	1368	ITRUE RMS HARMONIC 34 [%] MSW	L3	Measurement of the Phase - Neutral current of the i-th harmonic in comparison with the fundamental [%]	RO	FLOAT32
41370	1369	ITRUE RMS HARMONIC 34 [%] LSW			RO	
41371	1370	ITRUE RMS HARMONIC 35 [%] MSW	L1	Measurement of the Phase - Neutral current of the i-th harmonic in comparison with the fundamental [%]	RO	FLOAT32
41372	1371	ITRUE RMS HARMONIC 35 [%] LSW			RO	
41373	1372	ITRUE RMS HARMONIC 35 [%] MSW	L2	Measurement of the Phase - Neutral current of the i-th harmonic in comparison with the fundamental [%]	RO	FLOAT32
41374	1373	ITRUE RMS HARMONIC 35 [%] LSW			RO	

ADDRESS (4x)	ADDRESS OFFSET	REGISTER	PHASE	DESCRIPTION	W/R	TYPE
41375	1374	ITRUE RMS HARMONIC 35 [%] MSW	L3	Measurement of the Phase - Neutral current of the i-th harmonic in comparison with the fundamental [%]	RO	FLOAT32
41376	1375	ITRUE RMS HARMONIC 35 [%] LSW			RO	
41377	1376	ITRUE RMS HARMONIC 36 [%] MSW	L1	Measurement of the Phase - Neutral current of the i-th harmonic in comparison with the fundamental [%]	RO	FLOAT32
41378	1377	ITRUE RMS HARMONIC 36 [%] LSW			RO	
41379	1378	ITRUE RMS HARMONIC 36 [%] MSW	L2	Measurement of the Phase - Neutral current of the i-th harmonic in comparison with the fundamental [%]	RO	FLOAT32
41380	1379	ITRUE RMS HARMONIC 36 [%] LSW			RO	
41381	1380	ITRUE RMS HARMONIC 36 [%] MSW	L3	Measurement of the Phase - Neutral current of the i-th harmonic in comparison with the fundamental [%]	RO	FLOAT32
41382	1381	ITRUE RMS HARMONIC 36 [%] LSW			RO	
41383	1382	ITRUE RMS HARMONIC 37 [%] MSW	L1	Measurement of the Phase - Neutral current of the i-th harmonic in comparison with the fundamental [%]	RO	FLOAT32
41384	1383	ITRUE RMS HARMONIC 37 [%] LSW			RO	
41385	1384	ITRUE RMS HARMONIC 37 [%] MSW	L2	Measurement of the Phase - Neutral current of the i-th harmonic in comparison with the fundamental [%]	RO	FLOAT32
41386	1385	ITRUE RMS HARMONIC 37 [%] LSW			RO	
41387	1386	ITRUE RMS HARMONIC 37 [%] MSW	L3	Measurement of the Phase - Neutral	RO	FLOAT32
41388	1387	ITRUE RMS HARMONIC 37 [%] LSW			RO	

ADDRESS (4x)	ADDRESS OFFSET	REGISTER	PHASE	DESCRIPTION	W/R	TYPE
				current of the i-th harmonic in comparison with the fundamental [%]		
41389	1388	ITRUE RMS HARMONIC 38 [%] MSW	L1	Measurement of the Phase - Neutral current of the i-th harmonic in comparison with the fundamental [%]	RO	FLOAT32
41390	1389	ITRUE RMS HARMONIC 38 [%] LSW			RO	
41391	1390	ITRUE RMS HARMONIC 38 [%] MSW	L2	Measurement of the Phase - Neutral current of the i-th harmonic in comparison with the fundamental [%]	RO	FLOAT32
41392	1391	ITRUE RMS HARMONIC 38 [%] LSW			RO	
41393	1392	ITRUE RMS HARMONIC 38 [%] MSW	L3	Measurement of the Phase - Neutral current of the i-th harmonic in comparison with the fundamental [%]	RO	FLOAT32
41394	1393	ITRUE RMS HARMONIC 38 [%] LSW			RO	
41395	1394	ITRUE RMS HARMONIC 39 [%] MSW	L1	Measurement of the Phase - Neutral current of the i-th harmonic in comparison with the fundamental [%]	RO	FLOAT32
41396	1395	ITRUE RMS HARMONIC 39 [%] LSW			RO	
41397	1396	ITRUE RMS HARMONIC 39 [%] MSW	L2	Measurement of the Phase - Neutral current of the i-th harmonic in comparison with the fundamental [%]	RO	FLOAT32
41398	1397	ITRUE RMS HARMONIC 39 [%] LSW			RO	
41399	1398	ITRUE RMS HARMONIC 39 [%] MSW	L3	Measurement of the Phase - Neutral current of the i-th harmonic in	RO	FLOAT32
41400	1399	ITRUE RMS HARMONIC 39 [%] LSW			RO	

ADDRESS (4x)	ADDRESS OFFSET	REGISTER	PHASE	DESCRIPTION	W/R	TYPE
				comparison with the fundamental [%]		
41401	1400	ITRUE RMS HARMONIC 40 [%] MSW	L1	Measurement of the Phase - Neutral current of the i-th harmonic in comparison with the fundamental [%]	RO	FLOAT32
41402	1401	ITRUE RMS HARMONIC 40 [%] LSW			RO	
41403	1402	ITRUE RMS HARMONIC 40 [%] MSW	L2	Measurement of the Phase - Neutral current of the i-th harmonic in comparison with the fundamental [%]	RO	FLOAT32
41404	1403	ITRUE RMS HARMONIC 40 [%] LSW			RO	
41405	1404	ITRUE RMS HARMONIC 40 [%] MSW	L3	Measurement of the Phase - Neutral current of the i-th harmonic in comparison with the fundamental [%]	RO	FLOAT32
41406	1405	ITRUE RMS HARMONIC 40 [%] LSW			RO	
41407	1406	ITRUE RMS HARMONIC 41 [%] MSW	L1	Measurement of the Phase - Neutral current of the i-th harmonic in comparison with the fundamental [%]	RO	FLOAT32
41408	1407	ITRUE RMS HARMONIC 41 [%] LSW			RO	
41409	1408	ITRUE RMS HARMONIC 41 [%] MSW	L2	Measurement of the Phase - Neutral current of the i-th harmonic in comparison with the fundamental [%]	RO	FLOAT32
41410	1409	ITRUE RMS HARMONIC 41 [%] LSW			RO	
41411	1410	ITRUE RMS HARMONIC 41 [%] MSW	L3	Measurement of the Phase - Neutral current of the i-th harmonic in comparison with	RO	FLOAT32
41412	1411	ITRUE RMS HARMONIC 41 [%] LSW			RO	

ADDRESS (4x)	ADDRESS OFFSET	REGISTER	PHASE	DESCRIPTION	W/R	TYPE
				the fundamental [%]		
41413	1412	ITRUE RMS HARMONIC 42 [%] MSW	L1	Measurement of the Phase - Neutral current of the i-th harmonic in comparison with the fundamental [%]	RO	FLOAT32
41414	1413	ITRUE RMS HARMONIC 42 [%] LSW			RO	
41415	1414	ITRUE RMS HARMONIC 42 [%] MSW	L2	Measurement of the Phase - Neutral current of the i-th harmonic in comparison with the fundamental [%]	RO	FLOAT32
41416	1415	ITRUE RMS HARMONIC 42 [%] LSW			RO	
41417	1416	ITRUE RMS HARMONIC 42 [%] MSW	L3	Measurement of the Phase - Neutral current of the i-th harmonic in comparison with the fundamental [%]	RO	FLOAT32
41418	1417	ITRUE RMS HARMONIC 42 [%] LSW			RO	
41419	1418	ITRUE RMS HARMONIC 43 [%] MSW	L1	Measurement of the Phase - Neutral current of the i-th harmonic in comparison with the fundamental [%]	RO	FLOAT32
41420	1419	ITRUE RMS HARMONIC 43 [%] LSW			RO	
41421	1420	ITRUE RMS HARMONIC 43 [%] MSW	L2	Measurement of the Phase - Neutral current of the i-th harmonic in comparison with the fundamental [%]	RO	FLOAT32
41422	1421	ITRUE RMS HARMONIC 43 [%] LSW			RO	
41423	1422	ITRUE RMS HARMONIC 43 [%] MSW	L3	Measurement of the Phase - Neutral current of the i-th harmonic in comparison with the fundamental [%]	RO	FLOAT32
41424	1423	ITRUE RMS HARMONIC 43 [%] LSW			RO	

ADDRESS (4x)	ADDRESS OFFSET	REGISTER	PHASE	DESCRIPTION	W/R	TYPE
41425	1424	ITRUE RMS HARMONIC 44 [%] MSW	L1	Measurement of the Phase - Neutral current of the i-th harmonic in comparison with the fundamental [%]	RO	FLOAT32
41426	1425	ITRUE RMS HARMONIC 44 [%] LSW			RO	
41427	1426	ITRUE RMS HARMONIC 44 [%] MSW	L2	Measurement of the Phase - Neutral current of the i-th harmonic in comparison with the fundamental [%]	RO	FLOAT32
41428	1427	ITRUE RMS HARMONIC 44 [%] LSW			RO	
41429	1428	ITRUE RMS HARMONIC 44 [%] MSW	L3	Measurement of the Phase - Neutral current of the i-th harmonic in comparison with the fundamental [%]	RO	FLOAT32
41430	1429	ITRUE RMS HARMONIC 44 [%] LSW			RO	
41431	1430	ITRUE RMS HARMONIC 45 [%] MSW	L1	Measurement of the Phase - Neutral current of the i-th harmonic in comparison with the fundamental [%]	RO	FLOAT32
41432	1431	ITRUE RMS HARMONIC 45 [%] LSW			RO	
41433	1432	ITRUE RMS HARMONIC 45 [%] MSW	L2	Measurement of the Phase - Neutral current of the i-th harmonic in comparison with the fundamental [%]	RO	FLOAT32
41434	1433	ITRUE RMS HARMONIC 45 [%] LSW			RO	
41435	1434	ITRUE RMS HARMONIC 45 [%] MSW	L3	Measurement of the Phase - Neutral current of the i-th harmonic in comparison with the fundamental [%]	RO	FLOAT32
41436	1435	ITRUE RMS HARMONIC 45 [%] LSW			RO	
41437	1436	ITRUE RMS HARMONIC 46 [%] MSW	L1	Measurement of the Phase - Neutral	RO	FLOAT32
41438	1437	ITRUE RMS HARMONIC 46 [%] LSW			RO	

ADDRESS (4x)	ADDRESS OFFSET	REGISTER	PHASE	DESCRIPTION	W/R	TYPE
				current of the i-th harmonic in comparison with the fundamental [%]		
41439	1438	ITRUE RMS HARMONIC 46 [%] MSW	L2	Measurement of the Phase - Neutral current of the i-th harmonic in comparison with the fundamental [%]	RO	FLOAT32
41440	1439	ITRUE RMS HARMONIC 46 [%] LSW			RO	
41441	1440	ITRUE RMS HARMONIC 46 [%] MSW	L3	Measurement of the Phase - Neutral current of the i-th harmonic in comparison with the fundamental [%]	RO	FLOAT32
41442	1441	ITRUE RMS HARMONIC 46 [%] LSW			RO	
41443	1442	ITRUE RMS HARMONIC 47 [%] MSW	L1	Measurement of the Phase - Neutral current of the i-th harmonic in comparison with the fundamental [%]	RO	FLOAT32
41444	1443	ITRUE RMS HARMONIC 47 [%] LSW			RO	
41445	1444	ITRUE RMS HARMONIC 47 [%] MSW	L2	Measurement of the Phase - Neutral current of the i-th harmonic in comparison with the fundamental [%]	RO	FLOAT32
41446	1445	ITRUE RMS HARMONIC 47 [%] LSW			RO	
41447	1446	ITRUE RMS HARMONIC 47 [%] MSW	L3	Measurement of the Phase - Neutral current of the i-th harmonic in comparison with the fundamental [%]	RO	FLOAT32
41448	1447	ITRUE RMS HARMONIC 47 [%] LSW			RO	
41449	1448	ITRUE RMS HARMONIC 48 [%] MSW	L1	Measurement of the Phase - Neutral current of the i-th harmonic in	RO	FLOAT32
41450	1449	ITRUE RMS HARMONIC 48 [%] LSW			RO	

ADDRESS (4x)	ADDRESS OFFSET	REGISTER	PHASE	DESCRIPTION	W/R	TYPE
				comparison with the fundamental [%]		
41451	1450	ITRUE RMS HARMONIC 48 [%] MSW	L2	Measurement of the Phase - Neutral current of the i-th harmonic in comparison with the fundamental [%]	RO	FLOAT32
41452	1451	ITRUE RMS HARMONIC 48 [%] LSW			RO	
41453	1452	ITRUE RMS HARMONIC 48 [%] MSW	L3	Measurement of the Phase - Neutral current of the i-th harmonic in comparison with the fundamental [%]	RO	FLOAT32
41454	1453	ITRUE RMS HARMONIC 48 [%] LSW			RO	
41455	1454	ITRUE RMS HARMONIC 49 [%] MSW	L1	Measurement of the Phase - Neutral current of the i-th harmonic in comparison with the fundamental [%]	RO	FLOAT32
41456	1455	ITRUE RMS HARMONIC 49 [%] LSW			RO	
41457	1456	ITRUE RMS HARMONIC 49 [%] MSW	L2	Measurement of the Phase - Neutral current of the i-th harmonic in comparison with the fundamental [%]	RO	FLOAT32
41458	1457	ITRUE RMS HARMONIC 49 [%] LSW			RO	
41459	1458	ITRUE RMS HARMONIC 49 [%] MSW	L3	Measurement of the Phase - Neutral current of the i-th harmonic in comparison with the fundamental [%]	RO	FLOAT32
41460	1459	ITRUE RMS HARMONIC 49 [%] LSW			RO	
41461	1460	ITRUE RMS HARMONIC 50 [%] MSW	L1	Measurement of the Phase - Neutral current of the i-th harmonic in comparison with	RO	FLOAT32
41462	1461	ITRUE RMS HARMONIC 50 [%] LSW			RO	

ADDRESS (4x)	ADDRESS OFFSET	REGISTER	PHASE	DESCRIPTION	W/R	TYPE
				the fundamental [%]		
41463	1462	ITRUE RMS HARMONIC 50 [%] MSW	L2	Measurement of the Phase - Neutral current of the i-th harmonic in comparison with the fundamental [%]	RO	FLOAT32
41464	1463	ITRUE RMS HARMONIC 50 [%] LSW			RO	
41465	1464	ITRUE RMS HARMONIC 50 [%] MSW	L3	Measurement of the Phase - Neutral current of the i-th harmonic in comparison with the fundamental [%]	RO	FLOAT32
41466	1465	ITRUE RMS HARMONIC 50 [%] LSW			RO	
41467	1466	ITRUE RMS HARMONIC 51 [%] MSW	L1	Measurement of the Phase - Neutral current of the i-th harmonic in comparison with the fundamental [%]	RO	FLOAT32
41468	1467	ITRUE RMS HARMONIC 51 [%] LSW			RO	
41469	1468	ITRUE RMS HARMONIC 51 [%] MSW	L2	Measurement of the Phase - Neutral current of the i-th harmonic in comparison with the fundamental [%]	RO	FLOAT32
41470	1469	ITRUE RMS HARMONIC 51 [%] LSW			RO	
41471	1470	ITRUE RMS HARMONIC 51 [%] MSW	L3	Measurement of the Phase - Neutral current of the i-th harmonic in comparison with the fundamental [%]	RO	FLOAT32
41472	1471	ITRUE RMS HARMONIC 51 [%] LSW			RO	
41473	1472	ITRUE RMS HARMONIC 52 [%] MSW	L1	Measurement of the Phase - Neutral current of the i-th harmonic in comparison with the fundamental [%]	RO	FLOAT32
41474	1473	ITRUE RMS HARMONIC 52 [%] LSW			RO	

ADDRESS (4x)	ADDRESS OFFSET	REGISTER	PHASE	DESCRIPTION	W/R	TYPE
41475	1474	ITRUE RMS HARMONIC 52 [%] MSW	L2	Measurement of the Phase - Neutral current of the i-th harmonic in comparison with the fundamental [%]	RO	FLOAT32
41476	1475	ITRUE RMS HARMONIC 52 [%] LSW			RO	
41477	1476	ITRUE RMS HARMONIC 52 [%] MSW	L3	Measurement of the Phase - Neutral current of the i-th harmonic in comparison with the fundamental [%]	RO	FLOAT32
41478	1477	ITRUE RMS HARMONIC 52 [%] LSW			RO	
41479	1478	ITRUE RMS HARMONIC 53 [%] MSW	L1	Measurement of the Phase - Neutral current of the i-th harmonic in comparison with the fundamental [%]	RO	FLOAT32
41480	1479	ITRUE RMS HARMONIC 53 [%] LSW			RO	
41481	1480	ITRUE RMS HARMONIC 53 [%] MSW	L2	Measurement of the Phase - Neutral current of the i-th harmonic in comparison with the fundamental [%]	RO	FLOAT32
41482	1481	ITRUE RMS HARMONIC 53 [%] LSW			RO	
41483	1482	ITRUE RMS HARMONIC 53 [%] MSW	L3	Measurement of the Phase - Neutral current of the i-th harmonic in comparison with the fundamental [%]	RO	FLOAT32
41484	1483	ITRUE RMS HARMONIC 53 [%] LSW			RO	
41485	1484	ITRUE RMS HARMONIC 54 [%] MSW	L1	Measurement of the Phase - Neutral current of the i-th harmonic in comparison with the fundamental [%]	RO	FLOAT32
41486	1485	ITRUE RMS HARMONIC 54 [%] LSW			RO	
41487	1486	ITRUE RMS HARMONIC 54 [%] MSW	L2	Measurement of the Phase - Neutral	RO	FLOAT32
41488	1487	ITRUE RMS HARMONIC 54 [%] LSW			RO	

ADDRESS (4x)	ADDRESS OFFSET	REGISTER	PHASE	DESCRIPTION	W/R	TYPE
				current of the i-th harmonic in comparison with the fundamental [%]		
41489	1488	ITRUE RMS HARMONIC 54 [%] MSW	L3	Measurement of the Phase - Neutral current of the i-th harmonic in comparison with the fundamental [%]	RO	FLOAT32
41490	1489	ITRUE RMS HARMONIC 54 [%] LSW			RO	
41491	1490	ITRUE RMS HARMONIC 55 [%] MSW	L1	Measurement of the Phase - Neutral current of the i-th harmonic in comparison with the fundamental [%]	RO	FLOAT32
41492	1491	ITRUE RMS HARMONIC 55 [%] LSW			RO	
41493	1492	ITRUE RMS HARMONIC 55 [%] MSW	L2	Measurement of the Phase - Neutral current of the i-th harmonic in comparison with the fundamental [%]	RO	FLOAT32
41494	1493	ITRUE RMS HARMONIC 55 [%] LSW			RO	
41495	1494	ITRUE RMS HARMONIC 55 [%] MSW	L3	Measurement of the Phase - Neutral current of the i-th harmonic in comparison with the fundamental [%]	RO	FLOAT32
41496	1495	ITRUE RMS HARMONIC 55 [%] LSW			RO	
41497	1496	VTRUE RMS AVG [V] MSW	L1	Average VTRUE RMS calculated over the configured average time [V]	RO	FLOAT32
41498	1497	VTRUE RMS AVG [V] LSW			RO	
41499	1498	VTRUE RMS AVG MIN [V] MSW	L1	Minimum VTRUE RMS calculated over the configured average time [V]	RW	FLOAT32
41500	1499	VTRUE RMS AVG MIN [V] LSW			RW	
41501	1500	VTRUE RMS AVG MAX [V] MSW	L1	Maximum VTRUE RMS calculated over the	RW	FLOAT32
41502	1501	VTRUE RMS AVG MAX [V] LSW			RW	

ADDRESS (4x)	ADDRESS OFFSET	REGISTER	PHASE	DESCRIPTION	W/R	TYPE
				configured average time [V]		
41503	1502	VTRUE RMS MIN [V] MSW	L1	Device minimum VTRUE RMS [V]	RW	FLOAT32
41504	1503	VTRUE RMS MIN [V] LSW			RW	
41505	1504	VTRUE RMS MAX [V] MSW	L1	Device maximum VTRUE RMS [V]	RW	FLOAT32
41506	1505	VTRUE RMS MAX [V] LSW			RW	
41507	1506	VTRUE RMS AVG [V] MSW	L2	Average VTRUE RMS calculated over the configured average time [V]	RO	FLOAT32
41508	1507	VTRUE RMS AVG [V] LSW			RO	
41509	1508	VTRUE RMS AVG MIN [V] MSW	L2	Minimum VTRUE RMS calculated over the configured average time [V]	RW	FLOAT32
41510	1509	VTRUE RMS AVG MIN [V] LSW			RW	
41511	1510	VTRUE RMS AVG MAX [V] MSW	L2	Maximum VTRUE RMS calculated over the configured average time [V]	RW	FLOAT32
41512	1511	VTRUE RMS AVG MAX [V] LSW			RW	
41513	1512	VTRUE RMS MIN [V] MSW	L2	Device minimum VTRUE RMS [V]	RW	FLOAT32
41514	1513	VTRUE RMS MIN [V] LSW			RW	
41515	1514	VTRUE RMS MAX [V] MSW	L2	Device maximum VTRUE RMS [V]	RW	FLOAT32
41516	1515	VTRUE RMS MAX [V] LSW			RW	
41517	1516	VTRUE RMS AVG [V] MSW	L3	Average VTRUE RMS calculated over the configured average time [V]	RO	FLOAT32
41518	1517	VTRUE RMS AVG [V] LSW			RO	
41519	1518	VTRUE RMS AVG MIN [V] MSW	L3	Minimum VTRUE RMS calculated over the configured average time [V]	RW	FLOAT32
41520	1519	VTRUE RMS AVG MIN [V] LSW			RW	
41521	1520	VTRUE RMS AVG MAX [V] MSW	L3	Maximum VTRUE RMS calculated over the configured average time [V]	RW	FLOAT32
41522	1521	VTRUE RMS AVG MAX [V] LSW			RW	
41523	1522	VTRUE RMS MIN [V] MSW	L3	Device minimum VTRUE RMS [V]	RW	FLOAT32
41524	1523	VTRUE RMS MIN [V] LSW			RW	
41525	1524	VTRUE RMS MAX [V] MSW	L3	Device maximum VTRUE RMS [V]	RW	FLOAT32
41526	1525	VTRUE RMS MAX [V] LSW			RW	
41527	1526	ITRUE RMS AVG MSW [A]	L1	Average ITRUE RMS calculated over the	RO	FLOAT32
41528	1527	ITRUE RMS AVG LSW [A]			RO	

ADDRESS (4x)	ADDRESS OFFSET	REGISTER	PHASE	DESCRIPTION	W/R	TYPE
				configured average time [A]		
41529	1528	ITRUE RMS AVG MIN MSW [A]	L1	Minimum ITRUE RMS calculated over the configured average time [A]	RW	FLOAT32
41530	1529	ITRUE RMS AVG MIN LSW [A]			RW	
41531	1530	ITRUE RMS AVG MAX MSW [A]	L1	Maximum ITRUE RMS calculated over the configured average time [A]	RW	FLOAT32
41532	1531	ITRUE RMS AVG MAX LSW [A]			RW	
41533	1532	ITRUE RMS MIN MSW [A]	L1	Minimum ITRUE RMS since device power up [A]	RW	FLOAT32
41534	1533	ITRUE RMS MIN LSW [A]			RW	
41535	1534	ITRUE RMS MAX MSW [A]	L1	Device maximum ITRUE RMS [A]	RW	FLOAT32
41536	1535	ITRUE RMS MAX LSW [A]			RW	
41537	1536	ITRUE RMS AVG MSW [A]	L2	Average ITRUE RMS calculated over the configured average time [A]	RO	FLOAT32
41538	1537	ITRUE RMS AVG LSW [A]			RO	
41539	1538	ITRUE RMS AVG MIN MSW [A]	L2	Minimum ITRUE RMS calculated over the configured average time [A]	RW	FLOAT32
41540	1539	ITRUE RMS AVG MIN LSW [A]			RW	
41541	1540	ITRUE RMS AVG MAX MSW [A]	L2	Maximum ITRUE RMS calculated over the configured average time [A]	RW	FLOAT32
41542	1541	ITRUE RMS AVG MAX LSW [A]			RW	
41543	1542	ITRUE RMS MIN MSW [A]	L2	Device minimum ITRUE RMS [A]	RW	FLOAT32
41544	1543	ITRUE RMS MIN LSW [A]			RW	
41545	1544	ITRUE RMS MAX MSW [A]	L2	Maximum ITRUE RMS since device power up [A]	RW	FLOAT32
41546	1545	ITRUE RMS MAX LSW [A]			RW	
41547	1546	ITRUE RMS AVG MSW [A]	L3	Average ITRUE RMS calculated over the configured average time [A]	RO	FLOAT32
41548	1547	ITRUE RMS AVG LSW [A]			RO	
41549	1548	ITRUE RMS AVG MIN MSW [A]	L3	Minimum ITRUE RMS calculated over the configured average time [A]	RW	FLOAT32
41550	1549	ITRUE RMS AVG MIN LSW [A]			RW	
41551	1550	ITRUE RMS AVG MAX MSW [A]	L3	Maximum ITRUE RMS calculated	RW	FLOAT32
41552	1551	ITRUE RMS AVG MAX LSW [A]			RW	

ADDRESS (4x)	ADDRESS OFFSET	REGISTER	PHASE	DESCRIPTION	W/R	TYPE
				over the configured average time [A]		
41553	1552	ITRUE RMS MIN MSW [A]	L3	Device minimum ITRUE RMS [A]	RW	FLOAT32
41554	1553	ITRUE RMS MIN LSW [A]			RW	
41555	1554	ITRUE RMS MAX MSW [A]	L3	Device maximum ITRUE RMS [A]	RW	FLOAT32
41556	1555	ITRUE RMS MAX LSW [A]			RW	
41557	1556	VTRUE RMS AVG [V] MSW	L1-L2	Average VTRUE RMS calculated over the configured average time [V]	RO	FLOAT32
41558	1557	VTRUE RMS AVG [V] LSW			RO	
41559	1558	VTRUE RMS AVG MIN [V] MSW	L1-L2	Minimum VTRUE RMS calculated over the configured average time [V]	RW	FLOAT32
41560	1559	VTRUE RMS AVG MIN [V] LSW			RW	
41561	1560	VTRUE RMS AVG MAX [V] MSW	L1-L2	Maximum VTRUE RMS calculated over the configured average time [V]	RW	FLOAT32
41562	1561	VTRUE RMS AVG MAX [V] LSW			RW	
41563	1562	VTRUE RMS MIN [V] MSW	L1-L2	Minimum VTRUE RMS since device power up [V]	RW	FLOAT32
41564	1563	VTRUE RMS MIN [V] LSW			RW	
41565	1564	VTRUE RMS MAX [V] MSW	L1-L2	Maximum VTRUE RMS since device power up [V]	RW	FLOAT32
41566	1565	VTRUE RMS MAX [V] LSW			RW	
41567	1566	VTRUE RMS AVG [V] MSW	L2-L3	Average VTRUE RMS calculated over the configured average time [V]	RO	FLOAT32
41568	1567	VTRUE RMS AVG [V] LSW			RO	
41569	1568	VTRUE RMS AVG MIN [V] MSW	L2-L3	Minimum VTRUE RMS calculated over the configured average time [V]	RW	FLOAT32
41570	1569	VTRUE RMS AVG MIN [V] LSW			RW	
41571	1570	VTRUE RMS AVG MAX [V] MSW	L2-L3	Maximum VTRUE RMS calculated over the configured average time [V]	RW	FLOAT32
41572	1571	VTRUE RMS AVG MAX [V] LSW			RW	
41573	1572	VTRUE RMS MIN [V] MSW	L2-L3	Minimum VTRUE RMS since device power up [V]	RW	FLOAT32
41574	1573	VTRUE RMS MIN [V] LSW			RW	
41575	1574	VTRUE RMS MAX [V] MSW	L2-L3	Maximum VTRUE RMS since device power up [V]	RW	FLOAT32
41576	1575	VTRUE RMS MAX [V] LSW			RW	

ADDRESS (4x)	ADDRESS OFFSET	REGISTER	PHASE	DESCRIPTION	W/R	TYPE
41577	1576	VTRUE RMS AVG [V] MSW	L3-L1	Average VTRUE RMS calculated over the configured average time [V]	RO	FLOAT32
41578	1577	VTRUE RMS AVG [V] LSW			RO	
41579	1578	VTRUE RMS AVG MIN [V] MSW	L3-L1	Minimum VTRUE RMS calculated over the configured average time [V]	RW	FLOAT32
41580	1579	VTRUE RMS AVG MIN [V] LSW			RW	
41581	1580	VTRUE RMS AVG MAX [V] MSW	L3-L1	Maximum VTRUE RMS calculated over the configured average time [V]	RW	FLOAT32
41582	1581	VTRUE RMS AVG MAX [V] LSW			RW	
41583	1582	VTRUE RMS MIN [V] MSW	L3-L1	Minimum VTRUE RMS since device power up [V]	RW	FLOAT32
41584	1583	VTRUE RMS MIN [V] LSW			RW	
41585	1584	VTRUE RMS MAX [V] MSW	L3-L1	Maximum VTRUE RMS since device power up [V]	RW	FLOAT32
41586	1585	VTRUE RMS MAX [V] LSW			RW	
41587	1586	P AVG [W] MSW	L1	Average Active Power calculated over the configured average time [W]	RO	FLOAT32
41588	1587	P AVG [W] LSW			RO	
41589	1588	P AVG MIN [W] MSW	L1	Minimum Active Power calculated over the configured average time [W]	RW	FLOAT32
41590	1589	P AVG MIN [W] LSW			RW	
41591	1590	P AVG MAX [W] MSW	L1	Maximum Active Power calculated over the configured average time [W]	RW	FLOAT32
41592	1591	P AVG MAX [W] LSW			RW	
41593	1592	P MIN [W] MSW	L1	Minimum Active Power since device power up [W]	RW	FLOAT32
41594	1593	P MIN [W] LSW			RW	
41595	1594	P MAX [W] MSW	L1	Maximum Active Power since device power up [W]	RW	FLOAT32
41596	1595	P MAX [W] LSW			RW	
41597	1596	P AVG [W] MSW	L2	Average Active Power calculated over the configured average time [W]	RO	FLOAT32
41598	1597	P AVG [W] LSW			RO	
41599	1598	P AVG MIN [W] MSW	L2	Minimum Active Power calculated over the	RW	FLOAT32
41600	1599	P AVG MIN [W] LSW			RW	

ADDRESS (4x)	ADDRESS OFFSET	REGISTER	PHASE	DESCRIPTION	W/R	TYPE
				configured average time [W]		
41601	1600	P AVG MAX [W] MSW	L2	Maximum Active Power calculated over the configured average time [WA]	RW	FLOAT32
41602	1601	P AVG MAX [W] LSW			RW	
41603	1602	P MIN [W] MSW	L2	Minimum Active Power since device power up [W]	RW	FLOAT32
41604	1603	P MIN [W] LSW			RW	
41605	1604	P MAX [W] MSW	L2	Maximum Active Power since device power up [W]	RW	FLOAT32
41606	1605	P MAX [W] LSW			RW	
41607	1606	P AVG [W] MSW	L3	Average Active Power calculated over the configured average time [W]	RO	FLOAT32
41608	1607	P AVG [W] LSW			RO	
41609	1608	P AVG MIN [W] MSW	L3	Minimum Active Power calculated over the configured average time [W]	RW	FLOAT32
41610	1609	P AVG MIN [W] LSW			RW	
41611	1610	P AVG MAX [W] MSW	L3	Maximum Active Power calculated over the configured average time [WA]	RW	FLOAT32
41612	1611	P AVG MAX [W] LSW			RW	
41613	1612	P MIN [W] MSW	L3	Minimum Active Power since device power up [W]	RW	FLOAT32
41614	1613	P MIN [W] LSW			RW	
41615	1614	P MAX [W] MSW	L3	Maximum Active Power since device power up [W]	RW	FLOAT32
41616	1615	P MAX [W] LSW			RW	
41617	1616	Q AVG [VAR] MSW	L1	Average Reactive Power calculated over the configured average time [VAR]	RO	FLOAT32
41618	1617	Q AVG [VAR] LSW			RO	
41619	1618	Q AVG MIN [VAR] MSW	L1	Minimum Reactive Power calculated over the configured average time [VAR]	RW	FLOAT32
41620	1619	Q AVG MIN [VAR] LSW			RW	
41621	1620	Q AVG MAX [VAR] MSW	L1	Maximum Reactive Power calculated over the configured average time [VAR]	RW	FLOAT32
41622	1621	Q AVG MAX [VAR] LSW			RW	
41623	1622	Q MIN [VAR] MSW	L1		RW	FLOAT32

ADDRESS (4x)	ADDRESS OFFSET	REGISTER	PHASE	DESCRIPTION	W/R	TYPE
41624	1623	Q MIN [VAR] LSW		Minimum Reactive Power since device power up [VAR]	RW	
41625	1624	Q MAX [VAR] MSW	L1	Maximum Reactive Power since device power up [VAR]	RW	FLOAT32
41626	1625	Q MAX [VAR] LSW			RW	
41627	1626	Q AVG [VAR] MSW	L2	Average Reactive Power calculated over the configured average time [VAR]	RO	FLOAT32
41628	1627	Q AVG [VAR] LSW			RO	
41629	1628	Q AVG MIN [VAR] MSW	L2	Minimum Reactive Power calculated over the configured average time [VAR]	RW	FLOAT32
41630	1629	Q AVG MIN [VAR] LSW			RW	
41631	1630	Q AVG MAX [VAR] MSW	L2	Maximum Reactive Power calculated over the configured average time [VAR]	RW	FLOAT32
41632	1631	Q AVG MAX [VAR] LSW			RW	
41633	1632	Q MIN [VAR] MSW	L2	Minimum Reactive Power since device power up [VAR]	RW	FLOAT32
41634	1633	Q MIN [VAR] LSW			RW	
41635	1634	Q MAX [VAR] MSW	L2	Maximum Reactive Power since device power up [VAR]	RW	FLOAT32
41636	1635	Q MAX [VAR] LSW			RW	
41637	1636	Q AVG [VAR] MSW	L3	Average Reactive Power calculated over the configured average time [VAR]	RO	FLOAT32
41638	1637	Q AVG [VAR] LSW			RO	
41639	1638	Q AVG MIN [VAR] MSW	L3	Minimum Reactive Power calculated over the configured average time [VAR]	RW	FLOAT32
41640	1639	Q AVG MIN [VAR] LSW			RW	
41641	1640	Q AVG MAX [VAR] MSW	L3	Maximum Reactive Power calculated over the configured average time [VAR]	RW	FLOAT32
41642	1641	Q AVG MAX [VAR] LSW			RW	
41643	1642	Q MIN [VAR] MSW	L3	Minimum Reactive Power since device power up [VAR]	RW	FLOAT32
41644	1643	Q MIN [VAR] LSW			RW	
41645	1644	Q MAX [VAR] MSW	L3	Maximum Reactive Power since device power up [VAR]	RW	FLOAT32
41646	1645	Q MAX [VAR] LSW			RW	
41647	1646	S AVG [VA] MSW	L1	Average Apparent Power calculated	RO	FLOAT32
41648	1647	S AVG [VA] LSW			RO	

ADDRESS (4x)	ADDRESS OFFSET	REGISTER	PHASE	DESCRIPTION	W/R	TYPE
				over the configured average time [VA]		
41649	1648	S AVG MIN [VA] MSW	L1	Minimum Apparent Power calculated over the configured average time [VA]	RW	FLOAT32
41650	1649	S AVG MIN [VA] LSW			RW	
41651	1650	S AVG MAX [VA] MSW	L1	Maximum Apparent Power calculated over the configured average time [VA]	RW	FLOAT32
41652	1651	S AVG MAX [VA] LSW			RW	
41653	1652	S MIN [VA] MSW	L1	Minimum Apparent Power since device power up [VA]	RW	FLOAT32
41654	1653	S MIN [VA] LSW			RW	
41655	1654	S MAX [VA] MSW	L1	Maximum Apparent Power since device power up [VA]	RW	FLOAT32
41656	1655	S MAX [VA] LSW			RW	
41657	1656	S AVG [VA] MSW	L2	Average Apparent Power calculated over the configured average time [VA]	RO	FLOAT32
41658	1657	S AVG [VA] LSW			RO	
41659	1658	S AVG MIN [VA] MSW	L2	Minimum Apparent Power calculated over the configured average time [VA]	RW	FLOAT32
41660	1659	S AVG MIN [VA] LSW			RW	
41661	1660	S AVG MAX [VA] MSW	L2	Maximum Apparent Power calculated over the configured average time [VA]	RW	FLOAT32
41662	1661	S AVG MAX [VA] LSW			RW	
41663	1662	S MIN [VA] MSW	L2	Minimum Apparent Power since device power up [VA]	RW	FLOAT32
41664	1663	S MIN [VA] LSW			RW	
41665	1664	S MAX [VA] MSW	L2	Maximum Apparent Power since device power up [VA]	RW	FLOAT32
41666	1665	S MAX [VA] LSW			RW	
41667	1666	S AVG [VA] MSW	L3	Average Apparent Power calculated over the configured average time [VA]	RO	FLOAT32
41668	1667	S AVG [VA] LSW			RO	
41669	1668	S AVG MIN [VA] MSW	L3		RW	FLOAT32

ADDRESS (4x)	ADDRESS OFFSET	REGISTER	PHASE	DESCRIPTION	W/R	TYPE
41670	1669	S AVG MIN [VA] LSW		Minimum Apparent Power calculated over the configured average time [VA]	RW	
41671	1670	S AVG MAX [VA] MSW	L3	Maximum Apparent Power calculated over the configured average time [VA]	RW	FLOAT32
41672	1671	S AVG MAX [VA] LSW			RW	
41673	1672	S MIN [VA] MSW	L3	Minimum Apparent Power since device power up [VA]	RW	FLOAT32
41674	1673	S MIN [VA] LSW			RW	
41675	1674	S MAX [VA] MSW	L3	Maximum Apparent Power since device power up [VA]	RW	FLOAT32
41676	1675	S MAX [VA] LSW			RW	
41677	1676	PF AVG MSW	L1	Average Power Factor calculated over the configured average time	RO	FLOAT32
41678	1677	PF AVG LSW			RO	
41679	1678	PF AVG MIN MSW	L1	Minimum Power Factor calculated over the configured average time	RW	FLOAT32
41680	1679	PF AVG MIN LSW			RW	
41681	1680	PF AVG MAX MSW	L1	Maximum Power Factor calculated over the configured average time	RW	FLOAT32
41682	1681	PF AVG MAX LSW			RW	
41683	1682	PF MIN MSW	L1	Minimum Power Factor since device power up	RW	FLOAT32
41684	1683	PF MIN LSW			RW	
41685	1684	PF MAX MSW	L1	Maximum Power Factor since device power up	RW	FLOAT32
41686	1685	PF MAX LSW			RW	
41687	1686	PF AVG MSW	L2	Average Power Factor calculated over the configured average time	RO	FLOAT32
41688	1687	PF AVG LSW			RO	
41689	1688	PF AVG MIN MSW	L2	Minimum Power Factor calculated over the configured average time	RW	FLOAT32
41690	1689	PF AVG MIN LSW			RW	
41691	1690	PF AVG MAX MSW	L2		RW	FLOAT32

ADDRESS (4x)	ADDRESS OFFSET	REGISTER	PHASE	DESCRIPTION	W/R	TYPE
41692	1691	PF AVG MAX LSW		Maximum Power Factor calculated over the configured average time	RW	
41693	1692	PF MIN MSW	L2	Minimum Power Factor since device power up	RW	FLOAT32
41694	1693	PF MIN LSW			RW	
41695	1694	PF MAX MSW	L2	Maximum Power Factor since device power up	RW	FLOAT32
41696	1695	PF MAX LSW			RW	
41697	1696	PF AVG MSW	L3	Average Power Factor calculated over the configured average time	RO	FLOAT32
41698	1697	PF AVG LSW			RO	
41699	1698	PF AVG MIN MSW	L3	Minimum Power Factor calculated over the configured average time	RW	FLOAT32
41700	1699	PF AVG MIN LSW			RW	
41701	1700	PF AVG MAX MSW	L3	Maximum Power Factor calculated over the configured average time	RW	FLOAT32
41702	1701	PF AVG MAX LSW			RW	
41703	1702	PF MIN MSW	L3	Minimum Power Factor since device power up	RW	FLOAT32
41704	1703	PF MIN LSW			RW	
41705	1704	PF MAX MSW	L3	Maximum Power Factor since device power up	RW	FLOAT32
41706	1705	PF MAX LSW			RW	
41707	1706	P AVG [W] MSW	3PH	Average Active Power calculated over the configured average time [W]	RO	FLOAT32
41708	1707	P AVG [W] LSW			RO	
41709	1708	P AVG MIN [W] MSW	3PH	Minimum Active Power calculated over the configured average time [W]	RW	FLOAT32
41710	1709	P AVG MIN [W] LSW			RW	
41711	1710	P AVG MAX [W] MSW	3PH	Maximum Active Power calculated over the configured average time [WA]	RW	FLOAT32
41712	1711	P AVG MAX [W] LSW			RW	
41713	1712	P MIN [W] MSW	3PH	Minimum Active Power since device power up [W]	RW	FLOAT32
41714	1713	P MIN [W] LSW			RW	

ADDRESS (4x)	ADDRESS OFFSET	REGISTER	PHASE	DESCRIPTION	W/R	TYPE
41715	1714	P MAX [W] MSW	3PH	Maximum Active Power since device power up [W]	RW	FLOAT32
41716	1715	P MAX [W] LSW			RW	
41717	1716	Q AVG [VAR] MSW	3PH	Average Reactive Power calculated over the configured average time [VAR]	RO	FLOAT32
41718	1717	Q AVG [VAR] LSW			RO	
41719	1718	Q AVG MIN [VAR] MSW	3PH	Minimum Reactive Power calculated over the configured average time [VAR]	RW	FLOAT32
41720	1719	Q AVG MIN [VAR] LSW			RW	
41721	1720	Q AVG MAX [VAR] MSW	3PH	Maximum Reactive Power calculated over the configured average time [VAR]	RW	FLOAT32
41722	1721	Q AVG MAX [VAR] LSW			RW	
41723	1722	Q MIN [VAR] MSW	3PH	Minimum Reactive Power since device power up [VAR]	RW	FLOAT32
41724	1723	Q MIN [VAR] LSW			RW	
41725	1724	Q MAX [VAR] MSW	3PH	Maximum Reactive Power since device power up [VAR]	RW	FLOAT32
41726	1725	Q MAX [VAR] LSW			RW	
41727	1726	S AVG [VA] MSW	3PH	Average Apparent Power calculated over the configured average time [VA]	RO	FLOAT32
41728	1727	S AVG [VA] LSW			RO	
41729	1728	S AVG MIN [VA] MSW	3PH	Minimum Apparent Power calculated over the configured average time [VA]	RW	FLOAT32
41730	1729	S AVG MIN [VA] LSW			RW	
41731	1730	S AVG MAX [VA] MSW	3PH	Maximum Apparent Power calculated over the configured average time [VA]	RW	FLOAT32
41732	1731	S AVG MAX [VA] LSW			RW	
41733	1732	S MIN [VA] MSW	3PH	Minimum Apparent Power since device power up [VA]	RW	FLOAT32
41734	1733	S MIN [VA] LSW			RW	
41735	1734	S MAX [VA] MSW	3PH	Maximum Apparent Power since device power up [VA]	RW	FLOAT32
41736	1735	S MAX [VA] LSW			RW	
41737	1736	PF AVG MSW	3PH	Average Power Factor calculated over the	RO	FLOAT32
41738	1737	PF AVG LSW			RO	

ADDRESS (4x)	ADDRESS OFFSET	REGISTER	PHASE	DESCRIPTION	W/R	TYPE
				configured average time		
41739	1738	PF AVG MIN MSW	3PH	Minimum Power Factor calculated over the configured average time	RW	FLOAT32
41740	1739	PF AVG MIN LSW			RW	
41741	1740	PF AVG MAX MSW	3PH	Maximum Power Factor calculated over the configured average time	RW	FLOAT32
41742	1741	PF AVG MAX LSW			RW	
41743	1742	PF MIN MSW	3PH	Minimum Power Factor since device power up	RW	FLOAT32
41744	1743	PF MIN LSW			RW	
41745	1744	PF MAX MSW	3PH	Maximum Power Factor since device power up	RW	FLOAT32
41746	1745	PF MAX LSW			RW	
41747	1746	E ACTIVE ENERGY (+) [Wh] MMSW	L1	Active Energy (Only +) Q1-Q4 [Wh]	RW	UNSIGNED64
41748	1747	E ACTIVE ENERGY (+) [Wh] MSW			RW	
41749	1748	E ACTIVE ENERGY (+) [Wh] LSW			RW	
41750	1749	E ACTIVE ENERGY (+) [Wh] LLSW			RW	
41751	1750	E ACTIVE ENERGY (+) [Wh] MMSW	L2	Active Energy (Only +) Q1-Q4 [Wh]	RW	UNSIGNED64
41752	1751	E ACTIVE ENERGY (+) [Wh] MSW			RW	
41753	1752	E ACTIVE ENERGY (+) [Wh] LSW			RW	
41754	1753	E ACTIVE ENERGY (+) [Wh] LLSW			RW	
41755	1754	E ACTIVE ENERGY (+) [Wh] MMSW	L3	Active Energy (Only +) Q1-Q4 [Wh]	RW	UNSIGNED64
41756	1755	E ACTIVE ENERGY (+) [Wh] MSW			RW	
41757	1756	E ACTIVE ENERGY (+) [Wh] LSW			RW	
41758	1757	E ACTIVE ENERGY (+) [Wh] LLSW			RW	
41759	1758	E ACTIVE ENERGY (-) [Wh] MMSW	L1	Active Energy (Only -) Q2-Q3 [Wh]	RW	UNSIGNED64
41760	1759	E ACTIVE ENERGY (-) [Wh] MSW			RW	
41761	1760	E ACTIVE ENERGY (-) [Wh] LSW			RW	
41762	1761	E ACTIVE ENERGY (-) [Wh] LLSW			RW	
41763	1762	E ACTIVE ENERGY (-) [Wh] MMSW	L2	Active Energy (Only -) Q2-Q3 [Wh]	RW	UNSIGNED64
41764	1763	E ACTIVE ENERGY (-) [Wh] MSW			RW	
41765	1764	E ACTIVE ENERGY (-) [Wh] LSW			RW	
41766	1765	E ACTIVE ENERGY (-) [Wh] LLSW			RW	
41767	1766	E ACTIVE ENERGY (-) [Wh] MMSW	L3	Active Energy (Only -) Q2-Q3 [Wh]	RW	UNSIGNED64
41768	1767	E ACTIVE ENERGY (-) [Wh] MSW			RW	
41769	1768	E ACTIVE ENERGY (-) [Wh] LSW			RW	
41770	1769	E ACTIVE ENERGY (-) [Wh] LLSW			RW	
41771	1770	E REACTIVE ENERGY (+) [VARh] MMSW	L1		RW	UNSIGNED64

ADDRESS (4x)	ADDRESS OFFSET	REGISTER	PHASE	DESCRIPTION	W/R	TYPE
41772	1771	E REACTIVE ENERGY (+) [VARh] MSW		Reactive Energy (Only +) Q1-Q2 [VARh]	RW	
41773	1772	E REACTIVE ENERGY (+) [VARh] LSW			RW	
41774	1773	E REACTIVE ENERGY (+) [VARh] LLSW			RW	
41775	1774	E REACTIVE ENERGY (+) [VARh] MMSW	L2	Reactive Energy (Only +) Q1-Q2 [VARh]	RW	UNSIGNED64
41776	1775	E REACTIVE ENERGY (+) [VARh] MSW			RW	
41777	1776	E REACTIVE ENERGY (+) [VARh] LSW			RW	
41778	1777	E REACTIVE ENERGY (+) [VARh] LLSW			RW	
41779	1778	E REACTIVE ENERGY (+) [VARh] MMSW	L3	Reactive Energy (Only +) Q1-Q2 [VARh]	RW	UNSIGNED64
41780	1779	E REACTIVE ENERGY (+) [VARh] MSW			RW	
41781	1780	E REACTIVE ENERGY (+) [VARh] LSW			RW	
41782	1781	E REACTIVE ENERGY (+) [VARh] LLSW			RW	
41783	1782	E REACTIVE ENERGY (-) [VARh] MMSW	L1	Reactive Energy (Only -) Q3-Q4 [VARh]	RW	UNSIGNED64
41784	1783	E REACTIVE ENERGY (-) [VARh] MSW			RW	
41785	1784	E REACTIVE ENERGY (-) [VARh] LSW			RW	
41786	1785	E REACTIVE ENERGY (-) [VARh] LLSW			RW	
41787	1786	E REACTIVE ENERGY (-) [VARh] MMSW	L2	Reactive Energy (Only -) Q3-Q4 [VARh]	RW	UNSIGNED64
41788	1787	E REACTIVE ENERGY (-) [VARh] MSW			RW	
41789	1788	E REACTIVE ENERGY (-) [VARh] LSW			RW	
41790	1789	E REACTIVE ENERGY (-) [VARh] LLSW			RW	
41791	1790	E REACTIVE ENERGY (-) [VARh] MMSW	L3	Reactive Energy (Only -) Q3-Q4 [VARh]	RW	UNSIGNED64
41792	1791	E REACTIVE ENERGY (-) [VARh] MSW			RW	
41793	1792	E REACTIVE ENERGY (-) [VARh] LSW			RW	
41794	1793	E REACTIVE ENERGY (-) [VARh] LLSW			RW	
41795	1794	E REACTIVE ENERGY (+)[VARh] MMSW	L1	Reactive Energy (Only +) Q1 [VARh]	RW	UNSIGNED64
41796	1795	E REACTIVE ENERGY (+)[VARh] MSW			RW	
41797	1796	E REACTIVE ENERGY (+)[VARh] LSW			RW	
41798	1797	E REACTIVE ENERGY (+)[VARh] LLSW			RW	
41799	1798	E REACTIVE ENERGY (+)[VARh] MMSW	L2	Reactive Energy (Only +) Q1 [VARh]	RW	UNSIGNED64

ADDRESS (4x)	ADDRESS OFFSET	REGISTER	PHASE	DESCRIPTION	W/R	TYPE
41800	1799	E REACTIVE ENERGY (+)[VARh] MSW			RW	
41801	1800	E REACTIVE ENERGY (+)[VARh] LSW			RW	
41802	1801	E REACTIVE ENERGY (+)[VARh] LLSW			RW	
41803	1802	E REACTIVE ENERGY (+)[VARh] MMSW	L3	Reactive Energy (Only +) Q1 [VARh]	RW	UNSIGNED64
41804	1803	E REACTIVE ENERGY (+)[VARh] MSW			RW	
41805	1804	E REACTIVE ENERGY (+)[VARh] LSW			RW	
41806	1805	E REACTIVE ENERGY (+)[VARh] LLSW			RW	
41807	1806	E REACTIVE ENERGY (-) [VARh] MMSW	L1	Reactive Energy (Only -) Q2 [VARh]	RW	UNSIGNED64
41808	1807	E REACTIVE ENERGY (-) [VARh] MSW			RW	
41809	1808	E REACTIVE ENERGY (-) [VARh] LSW			RW	
41810	1809	E REACTIVE ENERGY (-) [VARh] LLSW			RW	
41811	1810	E REACTIVE ENERGY (-) [VARh] MMSW	L2	Reactive Energy (Only -) Q2 [VARh]	RW	UNSIGNED64
41812	1811	E REACTIVE ENERGY (-) [VARh] MSW			RW	
41813	1812	E REACTIVE ENERGY (-) [VARh] LSW			RW	
41814	1813	E REACTIVE ENERGY (-) [VARh] LLSW			RW	
41815	1814	E REACTIVE ENERGY (-) [VARh] MMSW	L3	Reactive Energy (Only -) Q2 [VARh]	RW	UNSIGNED64
41816	1815	E REACTIVE ENERGY (-) [VARh] MSW			RW	
41817	1816	E REACTIVE ENERGY (-) [VARh] LSW			RW	
41818	1817	E REACTIVE ENERGY (-) [VARh] LLSW			RW	
41819	1818	E REACTIVE ENERGY (-)[VARh] MMSW	L1	Reactive Energy (Only -) Q4 [VARh]	RW	UNSIGNED64

ADDRESS (4x)	ADDRESS OFFSET	REGISTER	PHASE	DESCRIPTION	W/R	TYPE
41820	1819	E REACTIVE ENERGY (-) [VARh] MSW			RW	
41821	1820	E REACTIVE ENERGY (-) [VARh] LSW			RW	
41822	1821	E REACTIVE ENERGY (-) [VARh] LLSW			RW	
41823	1822	E REACTIVE ENERGY (-)[VARh] MMSW	L2	Reactive Energy (Only -) Q4 [VARh]	RW	UNSIGNED64
41824	1823	E REACTIVE ENERGY (-) [VARh] MSW			RW	
41825	1824	E REACTIVE ENERGY (-) [VARh] LSW			RW	
41826	1825	E REACTIVE ENERGY (-) [VARh] LLSW			RW	
41827	1826	E REACTIVE ENERGY (-)[VARh] MMSW	L3	Reactive Energy (Only -) Q4 [VARh]	RW	UNSIGNED64
41828	1827	E REACTIVE ENERGY (-) [VARh] MSW			RW	
41829	1828	E REACTIVE ENERGY (-) [VARh] LSW			RW	
41830	1829	E REACTIVE ENERGY (-) [VARh] LLSW			RW	
41831	1830	E REACTIVE ENERGY (-)[VARh] MMSW	L1	Reactive Energy (Only -) Q3 [VARh]	RW	UNSIGNED64
41832	1831	E REACTIVE ENERGY (-)[VARh] MSW			RW	
41833	1832	E REACTIVE ENERGY (-)[VARh] LSW			RW	
41834	1833	E REACTIVE ENERGY (-)[VARh] LLSW			RW	
41835	1834	E REACTIVE ENERGY (-)[VARh] MMSW	L2	Reactive Energy (Only -) Q3 [VARh]	RW	UNSIGNED64
41836	1835	E REACTIVE ENERGY (-) [VARh] MSW			RW	
41837	1836	E REACTIVE ENERGY (-) [VARh] LSW			RW	
41838	1837	E REACTIVE ENERGY (-) [VARh] LLSW			RW	
41839	1838	E REACTIVE ENERGY (-) [VARh] MMSW	L3	Reactive Energy (Only -) Q3 [VARh]	RW	UNSIGNED64

ADDRESS (4x)	ADDRESS OFFSET	REGISTER	PHASE	DESCRIPTION	W/R	TYPE
41840	1839	E REACTIVE ENERGY (-) [VARh] MSW			RW	
41841	1840	E REACTIVE ENERGY (-) [VARh] LSW			RW	
41842	1841	E REACTIVE ENERGY (-) [VARh] LLSW			RW	
41843	1842	E ACTIVE ENERGY [Wh] MMSW	L1	Total Active Energy [Wh]	RW	UNSIGNED64
41844	1843	E ACTIVE ENERGY [Wh] MSW			RW	
41845	1844	E ACTIVE ENERGY [Wh] LSW			RW	
41846	1845	E ACTIVE ENERGY [Wh] LLSW			RW	
41847	1846	E ACTIVE ENERGY [Wh] MMSW	L2	Total Active Energy [Wh]	RW	SIGNED64
41848	1847	E ACTIVE ENERGY [Wh] MSW			RW	
41849	1848	E ACTIVE ENERGY [Wh] LSW			RW	
41850	1849	E ACTIVE ENERGY [Wh] LLSW			RW	
41851	1850	E ACTIVE ENERGY [Wh] MMSW	L3	Total Active Energy [Wh]	RW	SIGNED64
41852	1851	E ACTIVE ENERGY [Wh] MSW			RW	
41853	1852	E ACTIVE ENERGY [Wh] LSW			RW	
41854	1853	E ACTIVE ENERGY [Wh] LLSW			RW	
41855	1854	E REACTIVE ENERGY [VARh] MMSW	L1	Total Reactive Energy [VARh]	RW	SIGNED64
41856	1855	E REACTIVE ENERGY [VARh] MSW			RW	
41857	1856	E REACTIVE ENERGY [VARh] LSW			RW	
41858	1857	E REACTIVE ENERGY [VARh] LLSW			RW	
41859	1858	E REACTIVE ENERGY [VARh] MMSW	L2	Total Reactive Energy [VARh]	RW	SIGNED64
41860	1859	E REACTIVE ENERGY [VARh] MSW			RW	
41861	1860	E REACTIVE ENERGY [VARh] LSW			RW	
41862	1861	E REACTIVE ENERGY [VARh] LLSW			RW	
41863	1862	E REACTIVE ENERGY [VARh] MMSW	L3	Total Reactive Energy [VARh]	RW	SIGNED64
41864	1863	E REACTIVE ENERGY [VARh] MSW			RW	
41865	1864	E REACTIVE ENERGY [VARh] LSW			RW	
41866	1865	E REACTIVE ENERGY [VARh] LLSW			RW	
41867	1866	E REACTIVE ENERGY [VARh] MMSW	L1	Total Apparent Energy [VAh]	RW	SIGNED64
41868	1867	E REACTIVE ENERGY [VARh] MSW			RW	
41869	1868	E REACTIVE ENERGY [VARh] LSW			RW	
41870	1869	E REACTIVE ENERGY [VARh] LLSW			RW	
41871	1870	E REACTIVE ENERGY [VARh] MMSW	L2	Total Apparent Energy [VAh]	RW	SIGNED64
41872	1871	E REACTIVE ENERGY [VARh] MSW			RW	
41873	1872	E REACTIVE ENERGY [VARh] LSW			RW	
41874	1873	E REACTIVE ENERGY [VARh] LLSW			RW	
41875	1874	E REACTIVE ENERGY [VARh] MMSW	L3	Total Apparent Energy [VAh]	RW	SIGNED64
41876	1875	E REACTIVE ENERGY [VARh] MSW			RW	

ADDRESS (4x)	ADDRESS OFFSET	REGISTER	PHASE	DESCRIPTION	W/R	TYPE
41877	1876	E REACTIVE ENERGY [VARh] LSW			RW	
41878	1877	E REACTIVE ENERGY [VARh] LLSW			RW	
41879	1878	E ACTIVE ENERGY (+) [Wh] MMSW	3PH	Active Energy (Only +) Q1-Q4 [Wh]	RW	UNSIGNED64
41880	1879	E ACTIVE ENERGY (+) [Wh] MSW			RW	
41881	1880	E ACTIVE ENERGY (+) [Wh] LSW			RW	
41882	1881	E ACTIVE ENERGY (+) [Wh] LLSW			RW	
41883	1882	E ACTIVE ENERGY (-) [Wh] MMSW			RW	
41884	1883	E ACTIVE ENERGY (-) [Wh] MSW	3PH	Active Energy (Only -) Q2-Q3 [Wh]	RW	UNSIGNED64
41885	1884	E ACTIVE ENERGY (-) [Wh] LSW			RW	
41886	1885	E ACTIVE ENERGY (-) [Wh] LLSW			RW	
41887	1886	E REACTIVE ENERGY (+) [VARh] MMSW			RW	
41888	1887	E REACTIVE ENERGY (+) [VARh] MSW	3PH	Reactive Energy (Only +) Q1-Q2 [Wh]	RW	UNSIGNED64
41889	1888	E REACTIVE ENERGY (+) [VARh] LSW			RW	
41890	1889	E REACTIVE ENERGY (+) [VARh] LLSW			RW	
41891	1890	E REACTIVE ENERGY (-) [VARh] MMSW			RW	
41892	1891	E REACTIVE ENERGY (-) [VARh] MSW	3PH	Reactive Energy (Only -) Q3-Q4 [Wh]	RW	UNSIGNED64
41893	1892	E REACTIVE ENERGY (-) [VARh] LSW			RW	
41894	1893	E REACTIVE ENERGY (-) [VARh] LLSW			RW	
41895	1894	E ACTIVE ENERGY [Wh] MMSW			RW	
41896	1895	E ACTIVE ENERGY [Wh] MSW	3PH	Total Active Energy [Wh]	RW	SIGNED64
41897	1896	E ACTIVE ENERGY [Wh] LSW			RW	
41898	1897	E ACTIVE ENERGY [Wh] LLSW			RW	
41899	1898	E REACTIVE ENERGY [VARh] MMSW			RW	
41900	1899	E REACTIVE ENERGY [VARh] MSW	3PH	Total Reactive Energy [Varh]	RW	SIGNED64
41901	1900	E REACTIVE ENERGY [VARh] LSW			RW	
41902	1901	E REACTIVE ENERGY [VARh] LLSW			RW	
41903	1902	E APPARENT ENERGY [VAh] MMSW			RW	
41904	1903	E APPARENT ENERGY [VAh] MSW	3PH	Total Apparent Energy [VAh]	RW	SIGNED64
41905	1904	E APPARENT ENERGY [VAh] LSW			RW	
41906	1905	E APPARENT ENERGY [VAh] LLSW			RW	
41923	1922	THD I AVG MSW			L1	
41924	1923	THD I AVG LSW	RO			
41925	1924	THD I AVG MIN MSW	L1	Minimum Current THD calculated over the configured average time	RW	FLOAT32
41926	1925	THD I AVG MIN LSW			RW	

ADDRESS (4x)	ADDRESS OFFSET	REGISTER	PHASE	DESCRIPTION	W/R	TYPE
41927	1926	THD I AVG MAX MSW	L1	Maximum Current THD calculated over the configured average time	RW	FLOAT32
41928	1927	THD I AVG MAX LSW			RW	
41929	1928	THD I MIN MSW	L1	Minimum Current THD since device power up	RW	FLOAT32
41930	1929	THD I MIN LSW			RW	
41931	1930	THD I MAX MSW	L1	Maximum Current THD since device power up	RW	FLOAT32
41932	1931	THD I MAX LSW			RW	
41933	1932	THD I AVG MSW	L2	Average Current THD calculated over the configured average time	RO	FLOAT32
41934	1933	THD I AVG LSW			RO	
41935	1934	THD I AVG MIN MSW	L2	Minimum Current THD calculated over the configured average time	RW	FLOAT32
41936	1935	THD I AVG MIN LSW			RW	
41937	1936	THD I AVG MAX MSW	L2	Maximum Current THD calculated over the configured average time	RW	FLOAT32
41938	1937	THD I AVG MAX LSW			RW	
41939	1938	THD I MIN MSW	L2	Minimum Current THD since device power up	RW	FLOAT32
41940	1939	THD I MIN LSW			RW	
41941	1940	THD I MAX MSW	L2	Maximum Current THD since device power up	RW	FLOAT32
41942	1941	THD I MAX LSW			RW	
41943	1942	THD I AVG MSW	L3	Average Current THD calculated over the configured average time	RO	FLOAT32
41944	1943	THD I AVG LSW			RO	
41945	1944	THD I AVG MIN MSW	L3	Minimum Current THD calculated over the configured average time	RW	FLOAT32
41946	1945	THD I AVG MIN LSW			RW	
41947	1946	THD I AVG MAX MSW	L3	Maximum Current THD calculated over the configured average time	RW	FLOAT32
41948	1947	THD I AVG MAX LSW			RW	
41949	1948	THD I MIN MSW	L3	Minimum Current THD since device power up	RW	FLOAT32
41950	1949	THD I MIN LSW			RW	

ADDRESS (4x)	ADDRESS OFFSET	REGISTER	PHASE	DESCRIPTION	W/R	TYPE
41951	1950	THD I MAX MSW	L3	Maximum Current THD since device power up	RW	FLOAT32
41952	1951	THD I MAX LSW			RW	
41953	1952	THD I AVG MSW	L1	Average Voltage THD calculated over the configured average time	RO	FLOAT32
41954	1953	THD V AVG LSW			RO	
41955	1954	THD V AVG MIN MSW	L1	Minimum Voltage THD calculated over the configured average time	RW	FLOAT32
41956	1955	THD V AVG MIN LSW			RW	
41957	1956	THD V AVG MAX MSW	L1	Maximum Voltage THD calculated over the configured average time	RW	FLOAT32
41958	1957	THD V AVG MAX LSW			RW	
41959	1958	THD V MIN MSW	L1	Minimum Voltage THD since device power up	RW	FLOAT32
41960	1959	THD V MIN LSW			RW	
41961	1960	THD V MAX MSW	L1	Maximum Voltage THD since device power up	RW	FLOAT32
41962	1961	THD V MAX LSW			RW	
41963	1962	THD I AVG MSW	L2	Average Voltage THD calculated over the configured average time	RO	FLOAT32
41964	1963	THD V AVG LSW			RO	
41965	1964	THD V AVG MIN MSW	L2	Minimum Voltage THD calculated over the configured average time	RW	FLOAT32
41966	1965	THD V AVG MIN LSW			RW	
41967	1966	THD V AVG MAX MSW	L2	Maximum Voltage THD calculated over the configured average time	RW	FLOAT32
41968	1967	THD V AVG MAX LSW			RW	
41969	1968	THD V MIN MSW	L2	Minimum Voltage THD since device power up	RW	FLOAT32
41970	1969	THD V MIN LSW			RW	
41971	1970	THD V MAX MSW	L2	Maximum Voltage THD since device power up	RW	FLOAT32
41972	1971	THD V MAX LSW			RW	
41973	1972	THD I AVG MSW	L3	Average Voltage THD calculated over the configured average time	RO	FLOAT32
41974	1973	THD V AVG LSW			RO	

ADDRESS (4x)	ADDRESS OFFSET	REGISTER	PHASE	DESCRIPTION	W/R	TYPE
41975	1974	THD V AVG MIN MSW	L3	Minimum Voltage THD calculated over the configured average time	RW	FLOAT32
41976	1975	THD V AVG MIN LSW			RW	
41977	1976	THD V AVG MAX MSW	L3	Maximum Voltage THD calculated over the configured average time	RW	FLOAT32
41978	1977	THD V AVG MAX LSW			RW	
41979	1978	THD V MIN MSW	L3	Minimum Voltage THD since device power up	RW	FLOAT32
41980	1979	THD V MIN LSW			RW	
41981	1980	THD V MAX MSW	L3	Maximum Voltage THD since device power up	RW	FLOAT32
41982	1981	THD V MAX LSW			RW	
41995	1994	Vsys [V] MSW	3PH	System Voltage (VL1+VL2+VL3)/3	RW	FLOAT32
41996	1995	Vsys [V] LSW			RW	
41997	1996	Isys [A] MSW	3PH	System Current (IL1+IL2+IL3)	RW	FLOAT32
41998	1997	Isys [A] LSW			RW	
42019	2018	COUNTER 1 MSW	-	Digital Input 1 Counter	RW	UNSIGNED INT 32
42020	2019	COUNTER 1 LSW			RW	
42021	2020	COUNTER 2 MSW	-	Digital Input 2 Counter	RW	UNSIGNED INT 32
42022	2021	COUNTER 2 LSW			RW	
42023	2022	E ACTIVE ENERGY (+) [KWh] MSW	L1	Active Energy (Only +) Q1-Q4	RO	FLOAT 32
42024	2023	E ACTIVE ENERGY (+) [KWh] LSW			RO	
42025	2024	E ACTIVE ENERGY (+) [KWh] MSW	L2	Active Energy (Only +) Q1-Q4	RO	FLOAT 32
42026	2025	E ACTIVE ENERGY (+) [KWh] LSW			RO	
42027	2026	E ACTIVE ENERGY (+) [KWh] MSW	L3	Active Energy (Only +) Q1-Q4	RO	FLOAT 32
42028	2027	E ACTIVE ENERGY (+) [KWh] LSW			RO	
42029	2028	E ACTIVE ENERGY (-) [KWh] MSW	L1	Active Energy (Only -) Q2-Q3	RO	FLOAT 32
42030	2029	E ACTIVE ENERGY (-) [KWh] LSW			RO	
42031	2030	E ACTIVE ENERGY (-) [KWh] MSW	L2	Active Energy (Only -) Q2-Q3	RO	FLOAT 32
42032	2031	E ACTIVE ENERGY (-) [KWh] LSW			RO	
42033	2032	E ACTIVE ENERGY (-) [KWh] MSW	L3	Active Energy (Only -) Q2-Q3	RO	FLOAT 32
42034	2033	E ACTIVE ENERGY (-) [KWh] LSW			RO	
42035	2034	E REACTIVE ENERGY (+) [KVARh] MSW	L1	Reactive Energy (Only +) Q1-Q2	RO	FLOAT 32
42036	2035	E REACTIVE ENERGY (+) [KVARh] LSW			RO	
42037	2036	E REACTIVE ENERGY (+) [KVARh] MSW	L2	Reactive Energy (Only +) Q1-Q2	RO	FLOAT 32
42038	2037	E REACTIVE ENERGY (+) [KVARh] LSW			RO	

ADDRESS (4x)	ADDRESS OFFSET	REGISTER	PHASE	DESCRIPTION	W/R	TYPE
42039	2038	E REACTIVE ENERGY (+) [KVARh] MSW	L3	Reactive Energy (Only +) Q1-Q2	RO	FLOAT 32
42040	2039	E REACTIVE ENERGY (+) [KVARh] LSW			RO	
42041	2040	E REACTIVE ENERGY (-) [KVARh] MSW	L1	Reactive Energy (Only -) Q3-Q4	RO	FLOAT 32
42042	2041				RO	
42043	2042	E REACTIVE ENERGY (-) [KVARh] LSW	L2	Reactive Energy (Only -) Q3-Q4	RO	FLOAT32
42044	2043	E REACTIVE ENERGY (-) [KVARh] MSW			RO	
42045	2044	E REACTIVE ENERGY (-) [KVARh] LSW	L3	Reactive Energy (Only -) Q3-Q4	RO	FLOAT32
42046	2045	E REACTIVE ENERGY (-) [KVARh] MSW			RO	
42047	2046	E REACTIVE ENERGY (+)[KVARh] MSW	L1	Reactive Energy (Only +) Q1 [KVARh]	RO	FLOAT32
42048	2047	E REACTIVE ENERGY (+)[KVARh] LSW			RO	
42049	2048	E REACTIVE ENERGY (+)[KVARh] MSW	L2	Reactive Energy (Only +) Q1 [KVARh]	RO	FLOAT32
42050	2049	E REACTIVE ENERGY (+)[KVARh] LSW			RO	
42051	2050	E REACTIVE ENERGY (+)[KVARh] MSW	L3	Reactive Energy (Only +) Q1 [KVARh]	RO	FLOAT32
42052	2051	E REACTIVE ENERGY (+)[KVARh] LSW			RO	
42053	2052	E REACTIVE ENERGY (-) [KVARh] MSW	L1	Reactive Energy (Only -) Q3 [KVARh]	RO	FLOAT32
42054	2053	E REACTIVE ENERGY (-) [KVARh] LSW			RO	
42055	2054	E REACTIVE ENERGY (-) [KVARh] MSW	L2	Reactive Energy (Only -) Q3 [KVARh]	RO	FLOAT32
42056	2055	E REACTIVE ENERGY (-) [KVARh] LSW			RO	
42057	2056	E REACTIVE ENERGY (-) [KVARh] MSW	L3	Reactive Energy (Only -) Q3 [KVARh]	RO	FLOAT32
42058	2057	E REACTIVE ENERGY (-) [KVARh] LSW			RO	
42059	2058	E REACTIVE ENERGY (+) [KVARh] MSW	L1	Reactive Energy (Only +) Q2 [KVARh]	RO	FLOAT32
42060	2059	E REACTIVE ENERGY (+) [KVARh] LSW			RO	
42061	2060	E REACTIVE ENERGY (+) [KVARh] MSW	L2	Reactive Energy (Only +) Q2 [KVARh]	RO	FLOAT32
42062	2061	E REACTIVE ENERGY (+) [KVARh] LSW			RO	
42063	2062	E REACTIVE ENERGY (+) [KVARh] MSW	L3	Reactive Energy (Only +) Q2 [KVARh]	RO	FLOAT32
42064	2063	E REACTIVE ENERGY (+) [KVARh] LSW			RO	
42065	2064	E REACTIVE ENERGY (-) [KVARh] MSW	L1	Reactive Energy (Only -) Q4 [KVARh]	RO	FLOAT32
42066	2065	E REACTIVE ENERGY (-) [KVARh] LSW			RO	

ADDRESS (4x)	ADDRESS OFFSET	REGISTER	PHASE	DESCRIPTION	W/R	TYPE
42067	2066	E REACTIVE ENERGY (-) [KVARh] MSW	L2	Reactive Energy (Only -) Q4 [KVARh]	RO	FLOAT32
42068	2067	E REACTIVE ENERGY (-) [KVARh] LSW			RO	
42069	2068	E REACTIVE ENERGY (-) [KVARh] MSW	L3	Reactive Energy (Only -) Q4 [KVARh]	RO	FLOAT32
42070	2069	E REACTIVE ENERGY (-) [KVARh] LSW			RO	
42071	2070	TOT E ACTIVE ENERGY [KWh] MSW	L1	Total Active Energy [KWh]	RO	FLOAT32
42072	2071	TOT E ACTIVE ENERGY [KWh] LSW			RO	
42073	2072	TOT E ACTIVE ENERGY [KWh] MSW	L2	Total Active Energy [KWh]	RO	FLOAT32
42074	2073	TOT E ACTIVE ENERGY [KWh] LSW			RO	
42075	2074	TOT E ACTIVE ENERGY [KWh] MSW	L3	Total Active Energy [KWh]	RO	FLOAT32
42076	2075	TOT E ACTIVE ENERGY [KWh] LSW			RO	
42077	2076	TOT E REACTIVE ENERGY [KVARh]MSW	L1	Total Reactive Energy [KVARh]	RO	FLOAT32
42078	2077	TOT E REACTIVE ENERGY [KVARh]LSW			RO	
42079	2078	TOT E REACTIVE ENERGY [KVARh]MSW	L2	Total Reactive Energy [KVARh]	RO	FLOAT32
42080	2079	TOT E REACTIVE ENERGY [KVARh]LSW			RO	
42081	2080	TOT E REACTIVE ENERGY [KVARh]MSW	L3	Total Reactive Energy [KVARh]	RO	FLOAT32
42082	2081	TOT E REACTIVE ENERGY [KVARh]LSW			RO	
42083	2082	TOT E APPARENT ENERGY [KVARh] MSW	L1	Total Apparent Energy [VAh]	RO	FLOAT32
42084	2083	TOT E APPARENT ENERGY [KVARh] LSW			RO	
42085	2084	TOT E APPARENT ENERGY [KVARh] MSW	L2	Total Apparent Energy [VAh]	RO	FLOAT32
42086	2085	TOT E APPARENT ENERGY [KVARh] LSW			RO	
42087	2086	TOT E APPARENT ENERGY [KVARh] MSW	L3	Total Apparent Energy [VAh]	RO	FLOAT32
42088	2087	TOT E APPARENT ENERGY [KVARh] LSW			RO	
42089	2088	E ACTIVE ENERGY (+) [KWh] MSW	3PH	Active Energy (Only +) Q1-Q4 [KWh]	RO	FLOAT32
42090	2089	E ACTIVE ENERGY (+) [KWh] LSW			RO	
42091	2090	E ACTIVE ENERGY (-) [KWh] MSW	3PH	Active Energy (Only -) Q2-Q3 [KWh]	RO	FLOAT32
42092	2091	E ACTIVE ENERGY (-) [KWh] LSW			RO	
42093	2092	E REACTIVE ENERGY (+) [KVARh] MSW	3PH	Reactive Energy (Only +) Q1-Q2 [KWh]	RO	FLOAT32
42094	2093	E REACTIVE ENERGY (+) [KVARh] LSW			RO	

ADDRESS (4x)	ADDRESS OFFSET	REGISTER	PHASE	DESCRIPTION	W/R	TYPE
42095	2094	E REACTIVE ENERGY (-) [KVARh] MSW	3PH	Reactive Energy (Only -) Q3-Q4 [KWh]	RO	FLOAT32
42096	2095	E REACTIVE ENERGY (-) [KVARh] LSW			RO	
42097	2096	TOT E ACTIVE ENERGY [KWh] MSW	3PH	Total Active Energy [KWh]	RO	FLOAT32
42098	2097	TOT E ACTIVE ENERGY [KWh] LSW			RO	
42099	2098	TOT E REACTIVE ENERGY [KVARh] MSW	3PH	Total Reactive Energy [KVARh]	RO	FLOAT32
42100	2099	TOT E REACTIVE ENERGY [KVARh] LSW			RO	
42101	2100	TOT E APPARENT ENERGY [KVAh] MSW	3PH	Total Apparent Energy [KVAh]	RO	FLOAT32
42102	2101	TOT E APPARENT ENERGY [KVAh] LSW			RO	
42103	2102	TOT E REACTIVE ENERGY (+) ABSORBED [KVARh] MSW	3PH	Total Absorbed Reactive Energy (+) [KVARh]	RO	FLOAT32
42104	2103	TOT E REACTIVE ENERGY (+) ABSORBED [KVARh] LSW			RO	
42105	2104	TOT E REACTIVE ENERGY (-) ABSORBED [KVARh] MSW	3PH	Total Absorbed Reactive Energy (-) [KVARh]	RO	FLOAT32
42106	2105	TOT E REACTIVE ENERGY (-) ABSORBED [KVARh] LSW			RO	
42107	2106	TOT E REACTIVE ENERGY (+) DELIVERED [KVARh] MSW	3PH	Total Delivered Reactive Energy (+) [KVARh]	RO	FLOAT32
42108	2107	TOT E REACTIVE ENERGY (+) DELIVERED [KVARh] LSW			RO	
42109	2108	TOT E REACTIVE ENERGY (-) DELIVERED [KVARh] MSW	3PH	Total Delivered Reactive Energy (-) [KVARh]	RO	FLOAT32
42110	2109	TOT E REACTIVE ENERGY (-) DELIVERED [KVARh] LSW			RO	
42111	2110	TOTAL REACTIVE ENERGY L1 MSW	3PH	Energia reattiva totale L1	RO	FLOAT32
42112	2111	TOTAL REACTIVE ENERGY L1 LSW			RO	
42113	2112	TOTAL REACTIVE ENERGY L2 MSW	3PH	Energia reattiva totale L2	RO	FLOAT32
42114	2113	TOTAL REACTIVE ENERGY L2 LSW			RO	
42115	2114	TOTAL REACTIVE ENERGY L3 MSW	3PH	Energia reattiva totale L3	RO	FLOAT32
42116	2115	TOTAL REACTIVE ENERGY L3 LSW			RO	
45075	5074	DEMAND VALUE [min]	-	Value of the demand value for the average [minutes]. The modification is enabled after a reboot.	RW*	UNSIGNED INT 32

23. PROFINET IO COMMUNICATION PROTOCOL (MODBUS PROTOCOL MODELS ONLY)

Type of protocol: Class A Device, Cyclic Real-time (RT) and Acyclic Data

23.1. CREATING A PROJECT WITH SIEMENS PLC (TIA PORTAL 16) (PROFINET IO PROTOCOL MODELS ONLY)

Creating a new project:

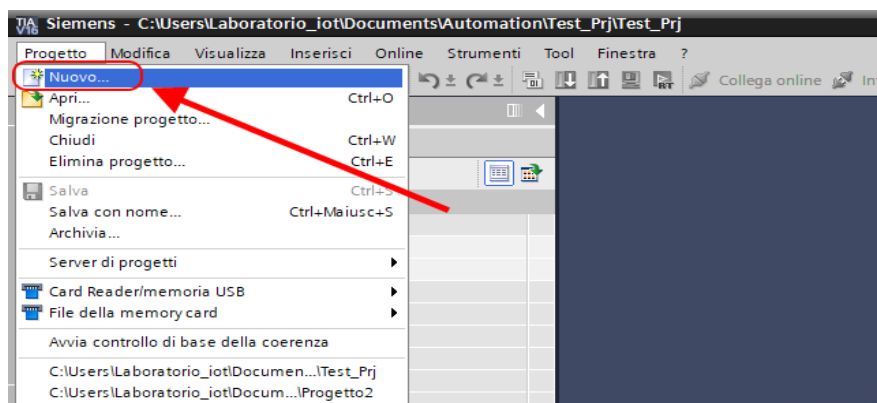

23.1.1. **INSTALLING THE GSDML FILE**

Install the GSDML file of the Seneca product

(it is possible to obtain the file on the web page of the device on the www.seneca.it site):

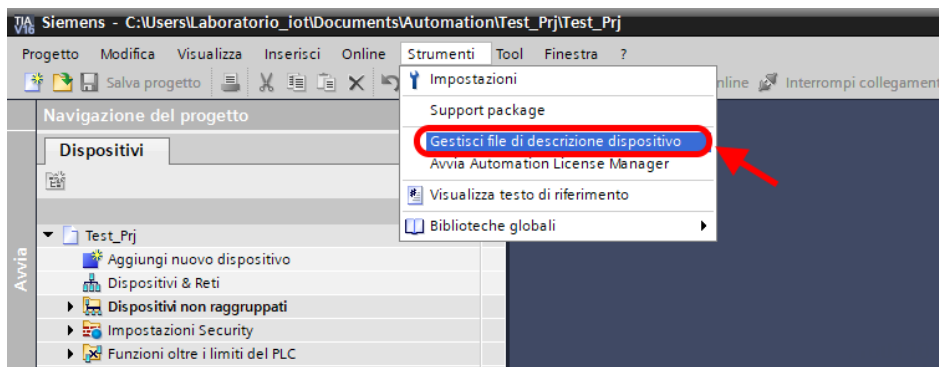

Point to the directory where the file is and press OK, then the list of GSD files in the folder will appear:

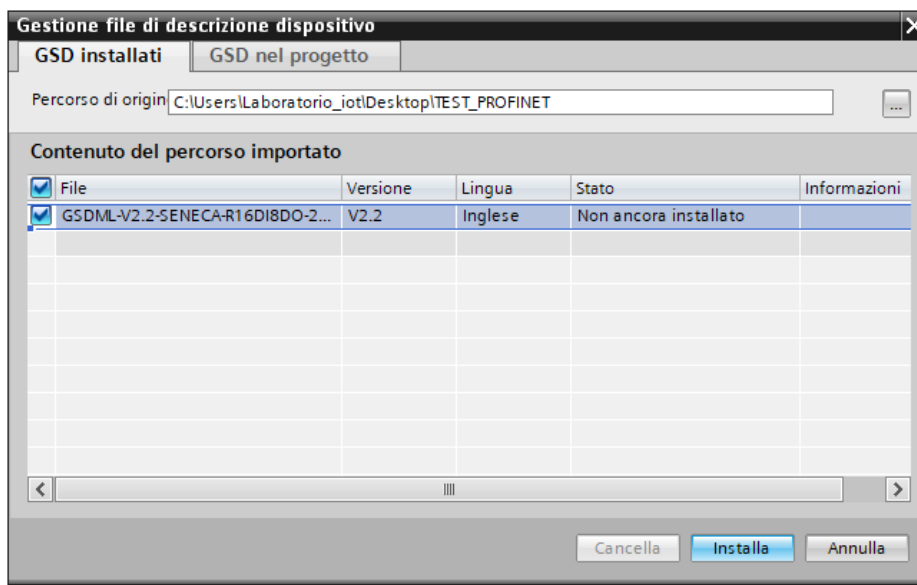

Click on "install".

23.1.2. INSERTION OF THE SIEMENS PLC IN THE PROJECT

Now insert the Siemens PLC (in our example a SIEMATIC S7 1200), click on "Add new device ...":

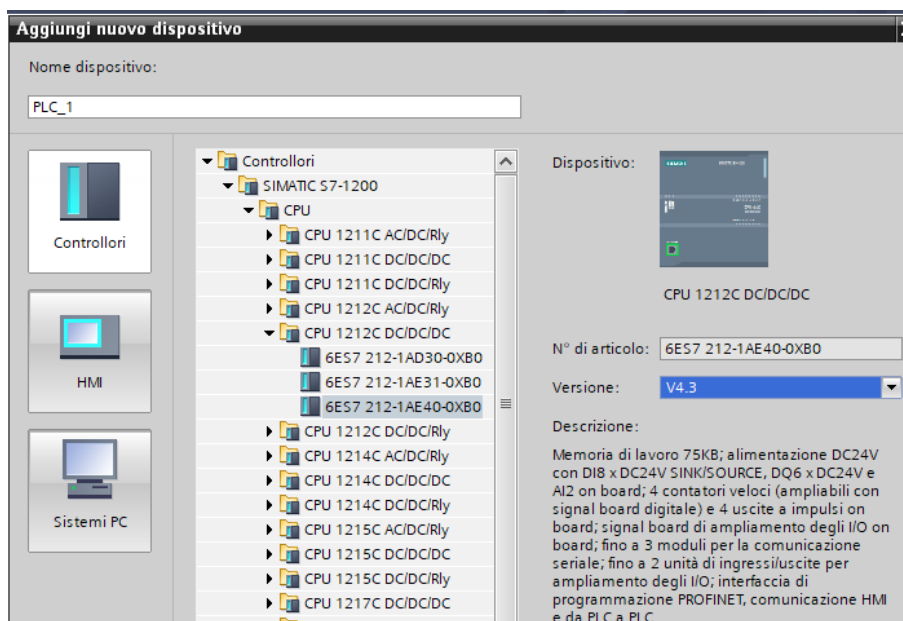
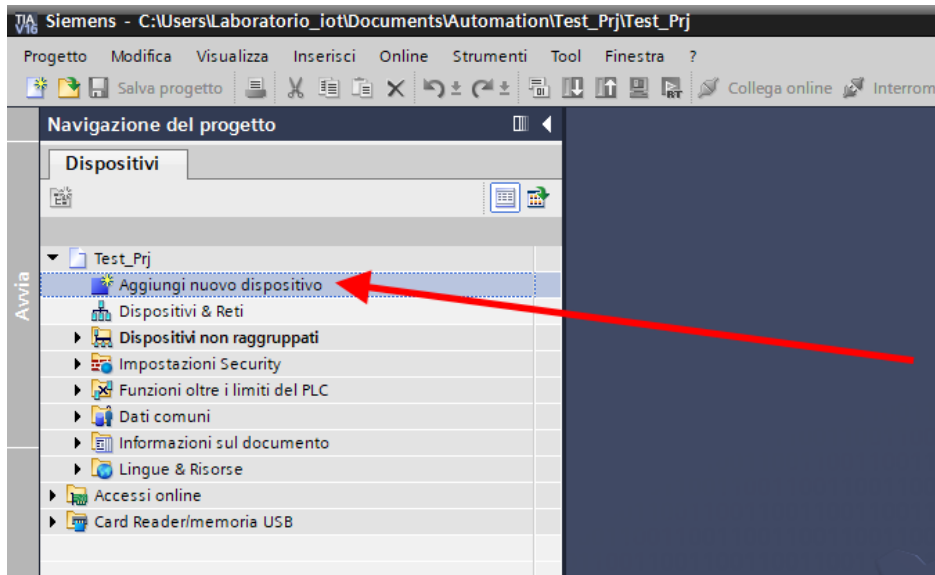

Confirm and the PLC will be added to the rack:

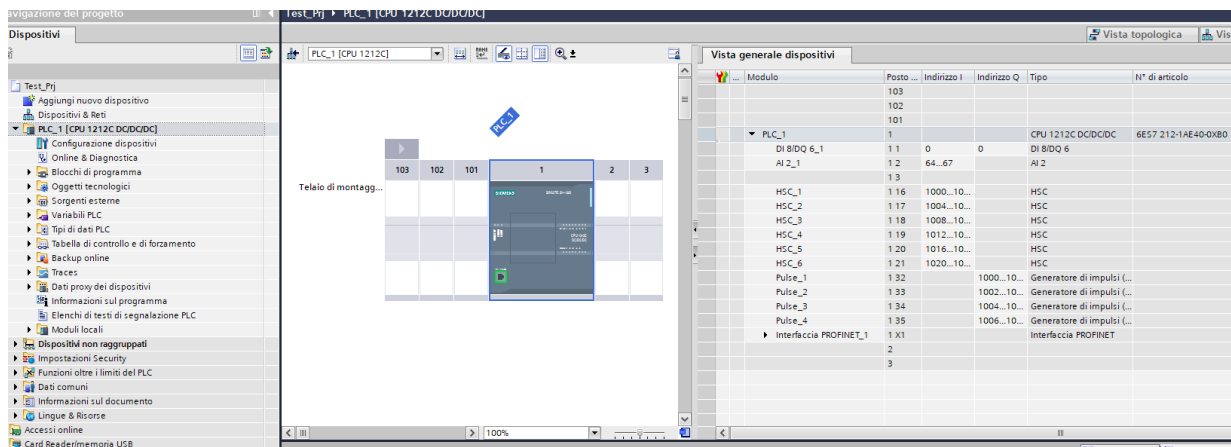

Now click on the PLC and select Profinet interface -> Ethernet addresses

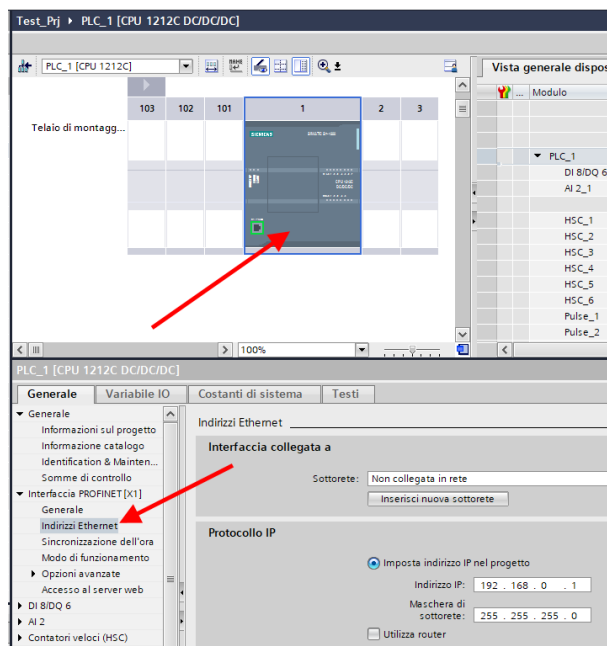

Set the IP you want (in this case 192.168.90.44) and the PLC subnet:

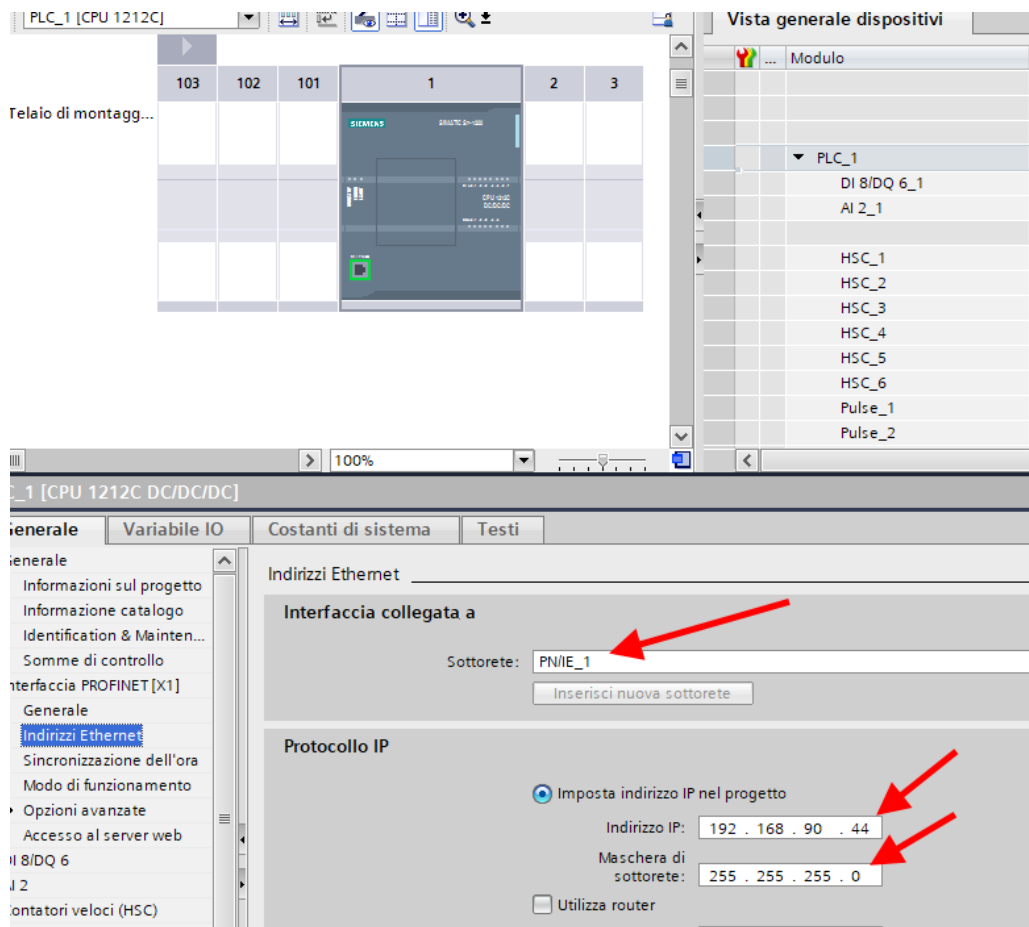

Move on to the network view:

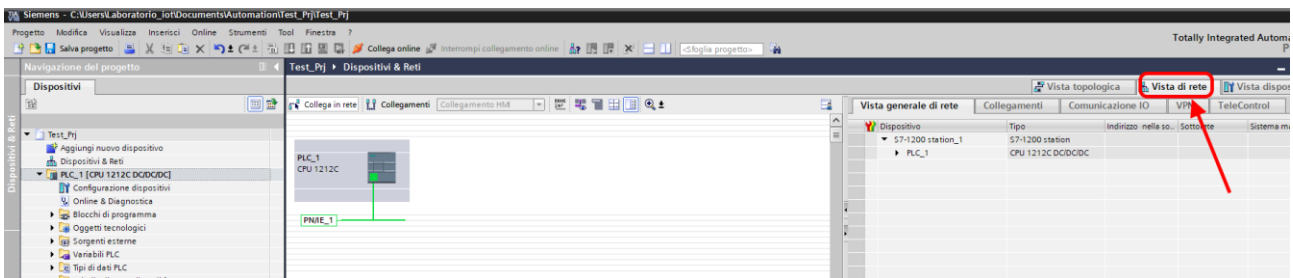

23.1.3. INSERTION OF THE PROFINET SENECA IO

On the right select "Hardware Catalogue" and then under "Additional Field Equipment" -> PROFINET IO -> Sensors -> Seneca S.R.L. -> Seneca R-Series Devices -> R-203-P Ethernet I/O

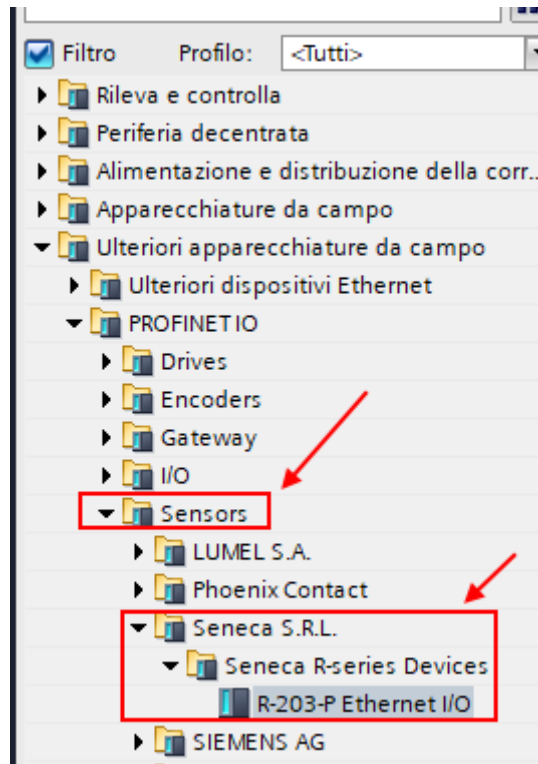

Drag the device to the network view:

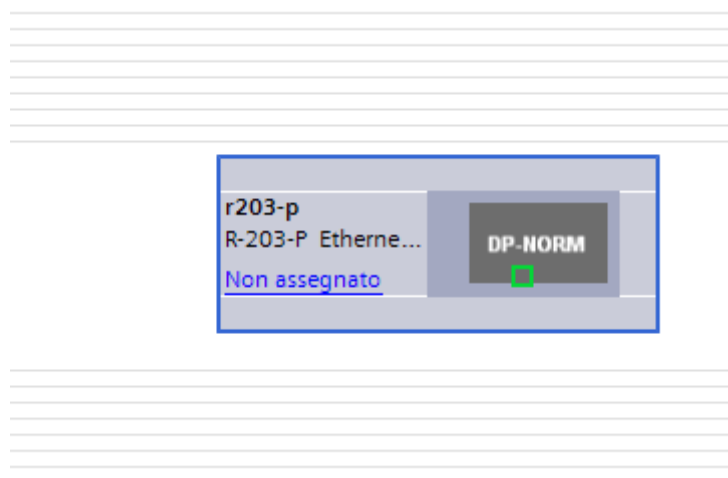

Now associate it to the PLC by clicking with the left mouse on "Not assigned" and then select the PLC:

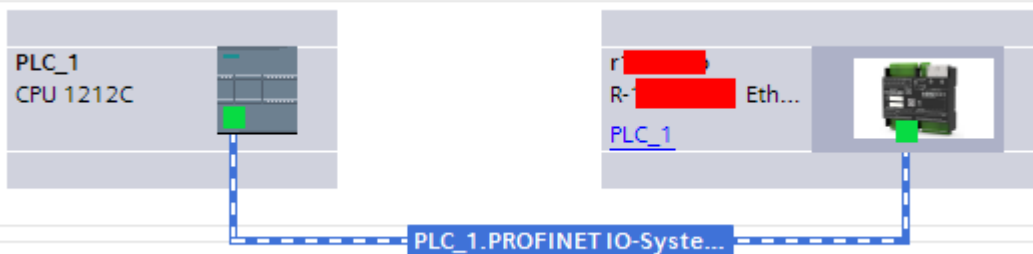
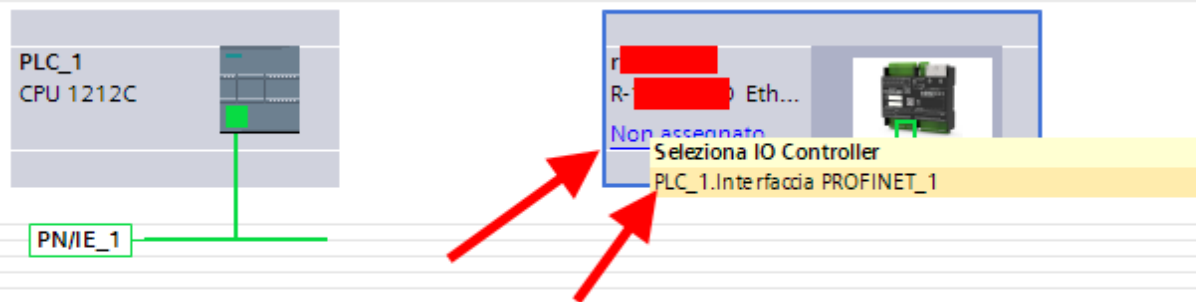

Click twice on the Seneca device and configure the IP address here too (for example 192.168.90.48):

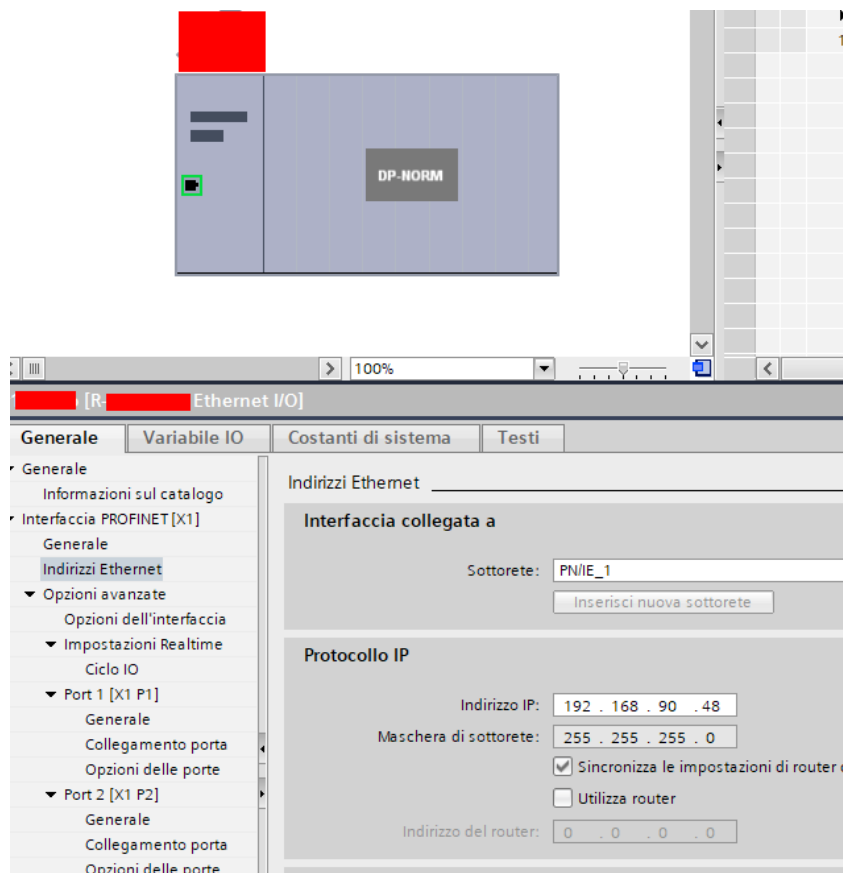

In Profinet the devices are identified by their name, so right click on the Seneca device and select "Assign device name"

ATTENTION!

AVOID INSERTING SPECIAL CHARACTERS IN THE PROFINET NAME OF THE DEVICE

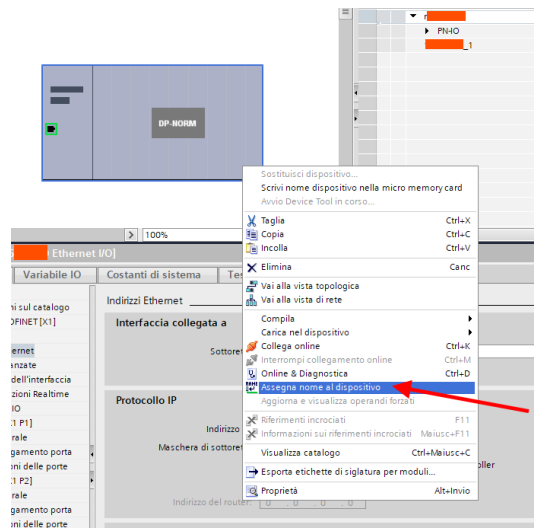

Scan the network with "Update list" and set (if necessary) the device name with "Assign name".

23.1.4. CONFIGURATION OF THE PARAMETERS OF THE SENECA DEVICE

It is also possible to directly configure the device IO without any external software. To configure the device, click on the IO so that the "Unit parameters" appear:

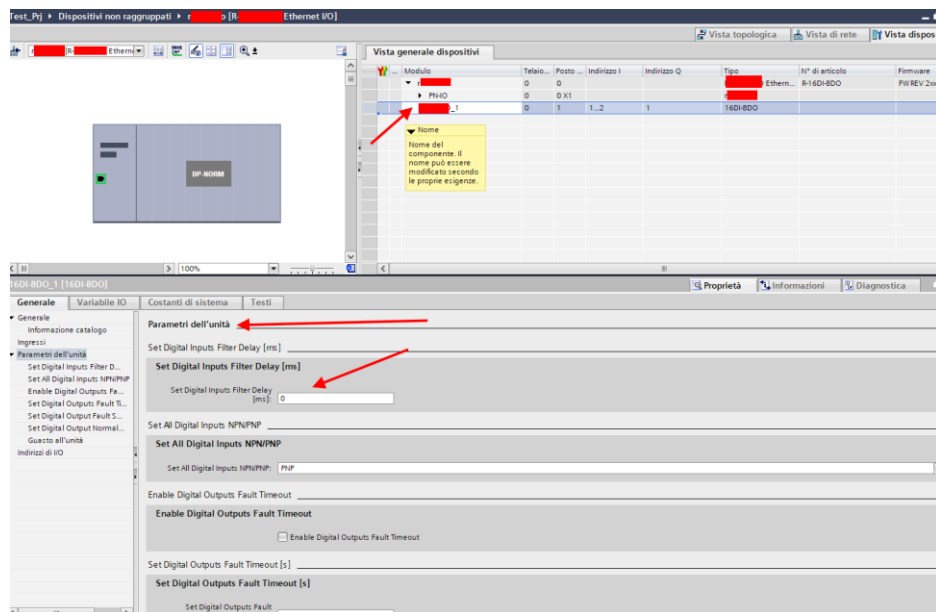

At the next start, the PLC will send the desired configuration to the device.

23.1.5. **CONFIGURATION PARAMETERS OF THE GSDML FILE**

CONNECTION TYPE

Sets the type of connection to make.

TA TYPE

Selects the type of sensor and the value of the TA secondary to be used between:

TA with current output

TA with MV output

Rogowski sensor

TA RATIO

Sets any TA ratio, the value to enter is related to the primary, example:

If a 50/5 TA has been installed, the value 50 must be entered as primary with the value 5 on the "TA TYPE" parameter.

TV TYPE

Sets the type of voltage transformer

TV RATIO

Sets the possible TV ratio

NETWORK FREQUENCY [Hz]

Sets the system to 50 or 60 Hz.

AVERAGE POWER WINDOW

Sets the time on which to measure the average values

USER CALIBRATION VOLTAGE

Sets a possible multiplication coefficient for the voltage measurement.

USER CALIBRATION CURRENT

Sets a possible multiplication coefficient for the current measurement.

CUTOFF CURRENT [A]

Sets a current value (on the primary) below which counters are stopped.

USER CALIBRATION ACTIVE ENERGY

Sets a possible multiplication coefficient for the active energy.

USER CALIBRATION REACTIVE ENERGY

Sets a possible multiplication coefficient for the reactive energy.

AO MODE

Sets whether the analog output is configured in Voltage [0V...10V] or Current [0mA...20mA].

This parameter will be only used for analog output models.

23.1.6. I/O DATA

You can now choose which variable groups to publish in Profinet.
Once the device inserted the following will appear:

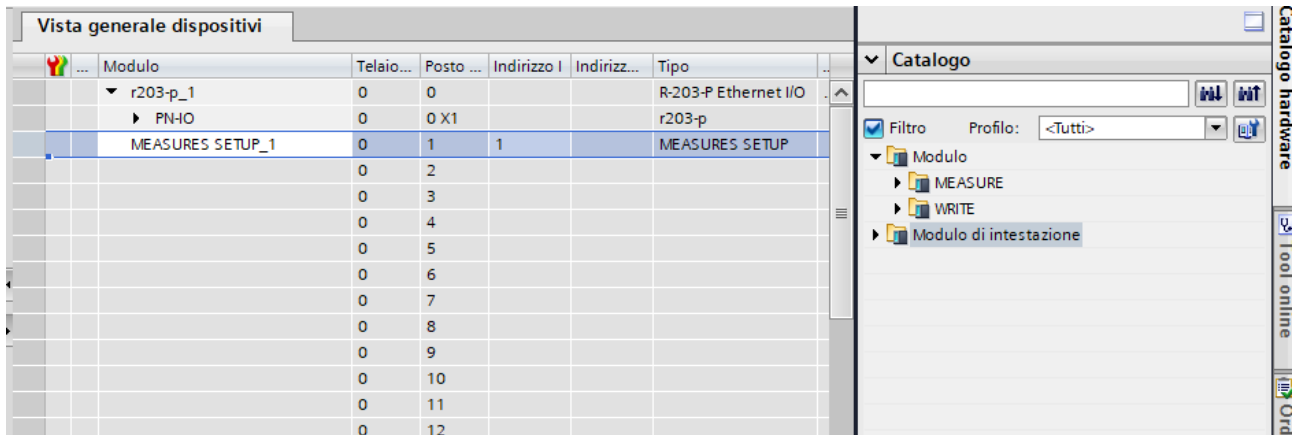

MEASURE_SETUP is a group of variables that is always present, while on the right there are “MEASURE” and “WRITE” variables.

You can add up to 15 variable groups.

The variable groups are optional, those that can be added are:

MEASURE SETUP (Always present)

Provides general information on the status of the inputs and the device:

Name	Data Type	Display as Bits	Length [Bytes]
STATUS	Unsigned8	Bit 0: CYCLIC PHASE SENSOR ERROR Bit 1: CURRENT CUT OFF Bit 2: CURRENT ERROR L1 Bit 3: CURRENT ERROR L2 Bit 4: CURRENT ERROR L3 Bit 5: LINE 1 VOLTAGE/CURRENT CONNECTION ERROR Bit 6: LINE 2 VOLTAGE/CURRENT CONNECTION ERROR Bit 7: LINE 3 VOLTAGE/CURRENT CONNECTION ERROR	1

For more information on the meaning of these Boolean values, refer to the chapter 15.

VOLTAGE

Provides the values of the phase-to-line and star voltages:

Name	Data Type	Display as Bits	Length [Bytes]
VL1L2	Float32	<input type="checkbox"/> No	4
VL2L3	Float32	<input type="checkbox"/> No	4
VL3L1	Float32	<input type="checkbox"/> No	4
VL1N	Float32	<input type="checkbox"/> No	4
VL2N	Float32	<input type="checkbox"/> No	4
VL3N	Float32	<input type="checkbox"/> No	4

CURRENT

Provides the values of the phase and neutral currents in [A]:

Name	Data Type	Display as Bits	Length [Bytes]
IL1	Float32	<input type="checkbox"/> No	4
IL2	Float32	<input type="checkbox"/> No	4
IL3	Float32	<input type="checkbox"/> No	4
IN	Float32	<input type="checkbox"/> No	4

ACTIVE REACTIVE APPARENT TOTAL POWER

Provides the total active, reactive and apparent power values in [KW], [KVAR], [KVA]:

Name	Data Type	Display as Bits	Length [Bytes]
ACTIVE POWER L1	Float32	<input type="checkbox"/> No	4
ACTIVE POWER L2	Float32	<input type="checkbox"/> No	4
ACTIVE POWER L3	Float32	<input type="checkbox"/> No	4
REACTIVE POWER L1	Float32	<input type="checkbox"/> No	4
REACTIVE POWER L2	Float32	<input type="checkbox"/> No	4
REACTIVE POWER L3	Float32	<input type="checkbox"/> No	4
APPARENT POWER L1	Float32	<input type="checkbox"/> No	4
APPARENT POWER L2	Float32	<input type="checkbox"/> No	4
APPARENT POWER L3	Float32	<input type="checkbox"/> No	4
TOTAL ACTIVE POWER	Float32	<input type="checkbox"/> No	4
TOTAL REACTIVE POWER	Float32	<input type="checkbox"/> No	4
TOTAL APPARENT POWER	Float32	<input type="checkbox"/> No	4

ANGLE

Provides the values of the vector phase shift in [°]

Name	Data Type	Display as Bits	Length [Bytes]
ANGLE V/I L1	Float32	<input type="checkbox"/> No	4
ANGLE V/I L2	Float32	<input type="checkbox"/> No	4
ANGLE V/I L3	Float32	<input type="checkbox"/> No	4
ANGLE V/I L1 L2	Float32	<input type="checkbox"/> No	4
ANGLE V/I L2 L3	Float32	<input type="checkbox"/> No	4
ANGLE V/I L3 L1	Float32	<input type="checkbox"/> No	4

POWER FACTOR

Provides the power factor values:

Name	Data Type	Display as Bits	Length [Bytes]
POWER FACTOR L1	Float32	<input type="checkbox"/> No	4
POWER FACTOR L2	Float32	<input type="checkbox"/> No	4
POWER FACTOR L3	Float32	<input type="checkbox"/> No	4
POWER FACTOR TOTAL	Float32	<input type="checkbox"/> No	4

FREQUENCY PERIOD

Provides frequency [Hz] and period [ms] values:

Name	Data Type	Display as Bits	Length [Bytes]
FREQUENCY L1	Float32	<input type="checkbox"/> No	4
FREQUENCY L2	Float32	<input type="checkbox"/> No	4
FREQUENCY L3	Float32	<input type="checkbox"/> No	4
PERIOD L1	Float32	<input type="checkbox"/> No	4
PERIOD L2	Float32	<input type="checkbox"/> No	4
PERIOD L3	Float32	<input type="checkbox"/> No	4

THD

Provides the Total Harmonic Distortion in [%]

Name	Data Type	Display as Bits	Length [Bytes]
THD V L1	Float32	<input type="checkbox"/> No	4
THD V L2	Float32	<input type="checkbox"/> No	4
THD V L3	Float32	<input type="checkbox"/> No	4
THD I L1	Float32	<input type="checkbox"/> No	4
THD I L2	Float32	<input type="checkbox"/> No	4
THD I L3	Float32	<input type="checkbox"/> No	4

AVERAGE

Provides the values averaged over the demand time configured in [V], [A], [KW], [KVAR], [KVA]

Name	Data Type	Display as Bits	Length [Bytes]
AVG V L1	Float32	<input type="checkbox"/> No	4
AVG V L2	Float32	<input type="checkbox"/> No	4
AVG V L3	Float32	<input type="checkbox"/> No	4
AVG I L1	Float32	<input type="checkbox"/> No	4
AVG I L2	Float32	<input type="checkbox"/> No	4
AVG I L3	Float32	<input type="checkbox"/> No	4
AVG ACTIVE POWER 3PH	Float32	<input type="checkbox"/> No	4
AVG REACTIVE POWER 3PH	Float32	<input type="checkbox"/> No	4
AVG APPARENT POWER 3PH	Float32	<input type="checkbox"/> No	4

MIN

Provides the minimum values of the measurements in [V], [A], [KW], [KVAR], [KVA]:

Name	Data Type	Display as Bits	Length [Bytes]
MIN V L1	Float32	No	4
MIN V L2	Float32	No	4
MIN V L3	Float32	No	4
MIN I L1	Float32	No	4
MIN I L2	Float32	No	4
MIN I L3	Float32	No	4
MIN ACTIVE POWER 3PH	Float32	No	4
MIN REACTIVE POWER 3PH	Float32	No	4
MIN APPARENT POWER 3PH	Float32	No	4

MAX

Provides maximum measurement values in [V], [A], [KW], [KVAR], [KVA]:

Name	Data Type	Display as Bits	Length [Bytes]
MAX V L1	Float32	No	4
MAX V L2	Float32	No	4
MAX V L3	Float32	No	4
MAX I L1	Float32	No	4
MAX I L2	Float32	No	4
MAX I L3	Float32	No	4
MAX ACTIVE POWER 3PH	Float32	No	4
MAX REACTIVE POWER 3PH	Float32	No	4
MAX APPARENT POWER 3PH	Float32	No	4

ENERGY ACTIVE PHASE

Provides the values of phase active energy separated by quadrants, positive and negative and total in [KWh]:

Name	Data Type	Display as Bits	Length [Bytes]
ENERGY ACTIVE(+) Q1-Q4 L1	Float32	<input type="checkbox"/> No	4
ENERGY ACTIVE(+) Q1-Q4 L2	Float32	<input type="checkbox"/> No	4
ENERGY ACTIVE(+) Q1-Q4 L3	Float32	<input type="checkbox"/> No	4
ENERGY ACTIVE(-) Q2-Q3 L1	Float32	<input type="checkbox"/> No	4
ENERGY ACTIVE(-) Q2-Q3 L2	Float32	<input type="checkbox"/> No	4
ENERGY ACTIVE(-) Q2-Q3 L3	Float32	<input type="checkbox"/> No	4
ENERGY ACTIVE TOTAL L1	Float32	<input type="checkbox"/> No	4
ENERGY ACTIVE TOTAL L2	Float32	<input type="checkbox"/> No	4
ENERGY ACTIVE TOTAL L3	Float32	<input type="checkbox"/> No	4

ENERGY ACTIVE 3PH PHASE

Provides the values of the positive and negative and total three-phase active energy in [KWh]:

Name	Data Type	Display as Bits	Length [Bytes]
ENERGY ACTIVE 3PH (+) Q1-Q4	Float32	<input type="checkbox"/> No	4
ENERGY ACTIVE 3PH (-) Q2-Q3	Float32	<input type="checkbox"/> No	4
ENERGY ACTIVE TOTAL 3PH	Float32	<input type="checkbox"/> No	4

ENERGY REACTIVE Q1-Q2

Provides positive reactive energy values in [KVARh]:

Name	Data Type	Display as Bits	Length [Bytes]
ENERGY REACTIVE(+) Q1-Q2 L1	Float32	<input type="checkbox"/> No	4
ENERGY REACTIVE(+) Q1-Q2 L2	Float32	<input type="checkbox"/> No	4
ENERGY REACTIVE(+) Q1-Q2 L3	Float32	<input type="checkbox"/> No	4
ENERGY ACTIVE 3PH (+) Q1-Q2	Float32	<input type="checkbox"/> No	4

ENERGY REACTIVE Q3-Q4

Provides the values of the negative reactive energy in [KVARh]:

Name	Data Type	Display as Bits	Length [Bytes]
ENERGY REACTIVE(-) Q3-Q4 L1	Float32	<input type="checkbox"/> No	4
ENERGY REACTIVE(-) Q3-Q4 L2	Float32	<input type="checkbox"/> No	4
ENERGY REACTIVE(-) Q3-Q4 L3	Float32	<input type="checkbox"/> No	4
ENERGY ACTIVE 3PH (-) Q3-Q4	Float32	<input type="checkbox"/> No	4

ENERGY REACTIVE Q1

Provides the Q1 quadrant reactive energy values of each phase in [KVARh]:

Name	Data Type	Display as Bits	Length [Bytes]
ENERGY REACTIVE(+) Q1 L1	Float32	<input type="checkbox"/> No	4
ENERGY REACTIVE(+) Q1 L2	Float32	<input type="checkbox"/> No	4
ENERGY REACTIVE(+) Q1 L3	Float32	<input type="checkbox"/> No	4

ENERGY REACTIVE Q2

Provides the reactive energy values of the Q2 quadrant of each phase in [KVARh]:

Name	Data Type	Display as Bits	Length [Bytes]
ENERGY REACTIVE(-) Q2 L1	Float32	<input type="checkbox"/> No	4
ENERGY REACTIVE(-) Q2 L2	Float32	<input type="checkbox"/> No	4
ENERGY REACTIVE(-) Q2 L3	Float32	<input type="checkbox"/> No	4

ENERGY REACTIVE Q3

Provides the Q3 quadrant reactive energy values of each phase in [KVARh]:

Name	Data Type	Display as Bits	Length [Bytes]
ENERGY REACTIVE(+) Q3 L1	Float32	<input type="checkbox"/> No	4
ENERGY REACTIVE(+) Q3 L2	Float32	<input type="checkbox"/> No	4
ENERGY REACTIVE(+) Q3 L3	Float32	<input type="checkbox"/> No	4

ENERGY REACTIVE Q4

Provides the reactive energy values of the Q4 quadrant of each phase in [KVARh]:

Name	Data Type	Display as Bits	Length [Bytes]
ENERGY REACTIVE(-) Q4 L1	Float32	<input type="checkbox"/> No	4
ENERGY REACTIVE(-) Q4 L2	Float32	<input type="checkbox"/> No	4
ENERGY REACTIVE(-) Q4 L3	Float32	<input type="checkbox"/> No	4

ENERGY REACTIVE TOTAL

Provides the total reactive energy values of each phase and three-phase in [KVARh]:

Name	Data Type	Display as Bits	Length [Bytes]
ENERGY REACTIVE TOTAL L1	Float32	<input type="checkbox"/> No	4
ENERGY REACTIVE TOTAL L2	Float32	<input type="checkbox"/> No	4
ENERGY REACTIVE TOTAL L3	Float32	<input type="checkbox"/> No	4
ENERGY REACTIVE TOTAL 3PH	Float32	<input type="checkbox"/> No	4

ENERGY APPARENT TOTAL

Provides the total apparent energy values of each phase and three-phase in [KVARh]:

Name	Data Type	Display as Bits	Length [Bytes]
ENERGY APPARENT TOTAL L1	Float32	<input type="checkbox"/> No	4
ENERGY APPARENT TOTAL L2	Float32	<input type="checkbox"/> No	4
ENERGY APPARENT TOTAL L3	Float32	<input type="checkbox"/> No	4
ENERGY APPARENT TOTAL 3PH	Float32	<input type="checkbox"/> No	4

ENERGY REACTIVE ABSORBED TOTAL

Provides the values of the total absorbed reactive energy in [KVARh]:

Name	Data Type	Display as Bits	Length [Bytes]
ENERGY REACTIVE ABSORBED (+) TOTAL 3PH	Float32	<input type="checkbox"/> No	4
ENERGY REACTIVE ABSORBED (-) TOTAL 3PH	Float32	<input type="checkbox"/> No	4

ENERGY REACTIVE DELIVERED TOTAL

Provides the values of the total reactive energy delivered in [KVARh]:

Name	Data Type	Display as Bits	Length [Bytes]
ENERGY REACTIVE DELIVERED (+) TOTAL 3PH	Float32	<input type="checkbox"/> No	4
ENERGY REACTIVE DELIVERED (-) TOTAL 3PH	Float32	<input type="checkbox"/> No	4

DI

Provides the two analog input values:

Name	Data Type	Display as Bits	Length [Bytes]
DIGITAL INPUT	Unsigned8	Bit 0: DIN.1 Bit 1: DIN.2 Bit 2: NONE Bit 3: NONE Bit 4: NONE Bit 5: NONE Bit 6: NONE Bit 7: NONE	1

DO

Status (writable) with the value of the two digital outputs:

Name	Data Type	Display as Bits	Length [Bytes]
DO	Unsigned8	Bit 0: DOUT.1 Bit 1: DOUT.2 Bit 2: NONE Bit 3: NONE Bit 4: NONE Bit 5: NONE Bit 6: NONE Bit 7: NONE	1

AO

Status (writable) with the value of the analog output in [mA] or [V]:

Name	Data Type	Display as Bits	Length [Bytes]
AO VALUE	Float32	<input type="checkbox"/> No	4

NETWORK FREQUENCY

It allows you to change in real time the frequency and operation from 0 = 50Hz to 1= 60 Hz

Name	Data Type	Display as Bits	Length [Bytes]
NETWORK FREQUENCY VALUE	Unsigned8	No	1

COMMAND VALUE

It allows you to send commands to the device:

COMMAND CODE(decimal)	ACTION
260	Reset MIN/MAX
259	Reset AVG
261	Reset Energy Counters
40986	Load value in CMD_AUX register to COUNTER1
41002	Load value in CMD_AUX register to COUNTER2

Name	Data Type	Display as Bits	Length [Bytes]
COMMAND VALUE	Unsigned16	No	2

COMMAND AUX

Additional COMMAND Register to send special commands to the device

Name	Data Type	Display as Bits	Length [Bytes]
COMMAND AUX VALUE	Unsigned32	No	4

Now compile, send the project and go online with the PLC.

24. ETHERNET/IP COMMUNICATION PROTOCOL (ETHERNET/IP PROTOCOL MODELS ONLY)

EtherNet/IP (Ethernet Industrial Protocol) is an open field bus based on CIP (Common Industrial Protocol), developed by Rockwell Automation and ODVA (Open DeviceNet Vendor Association).

24.1. CREATING A PROJECT WITH PLC ALLEN BRADLEY/ROCKWELL (RS-LOGIX5000 / STUDIO 5000 LOGIX DESIGNER 35.00.00)

Once the PLC has been added to the project, import the EDS file of the device via the Tools-> EDS Hardware Installation Tool menu:

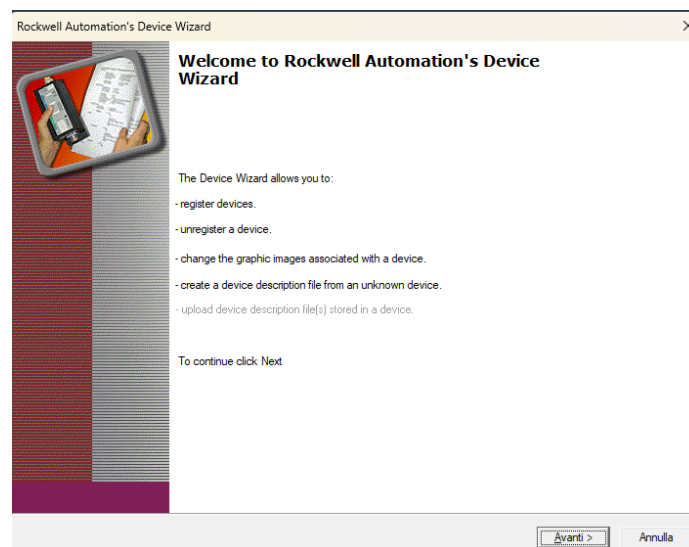
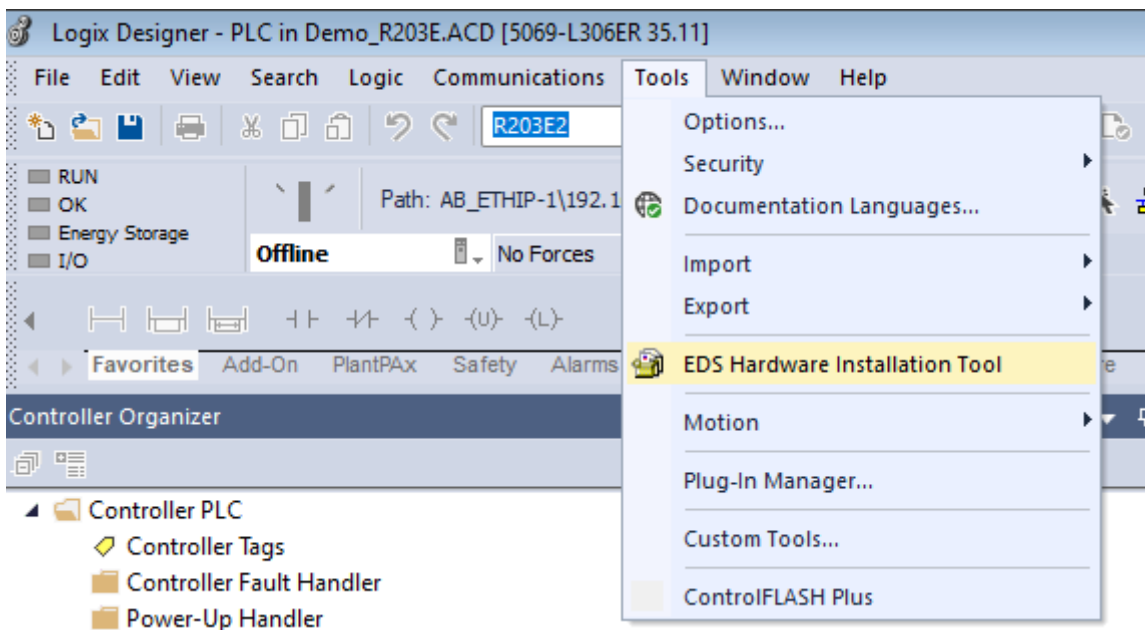

Press "Next", and select Add a new device:

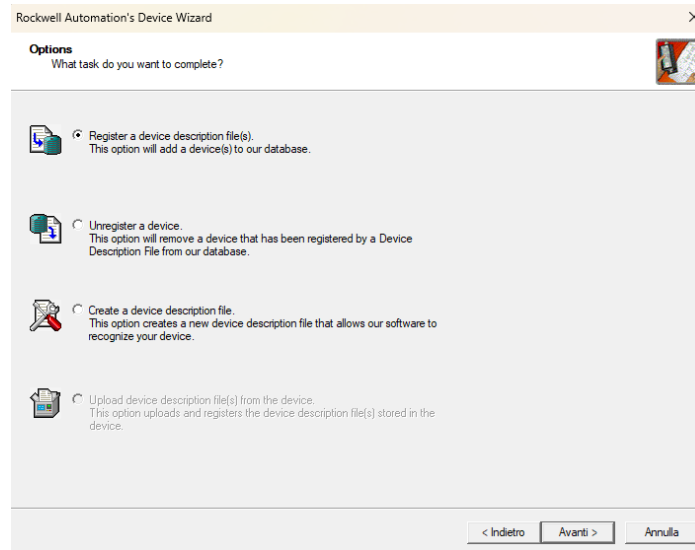

Select to register a single device and select the "R203-E.eds" file

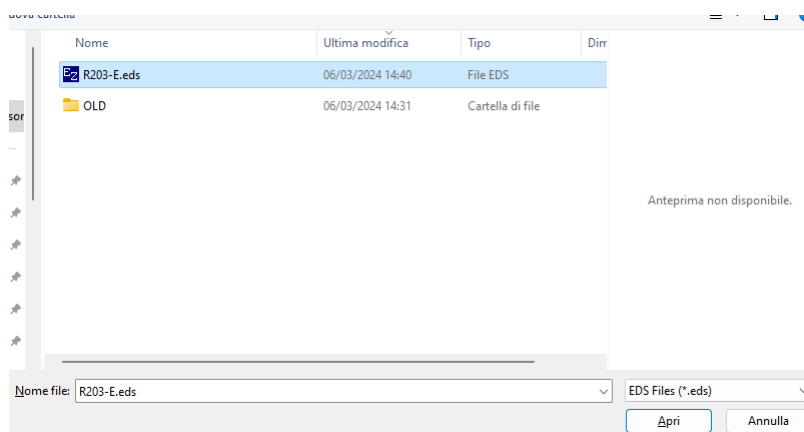
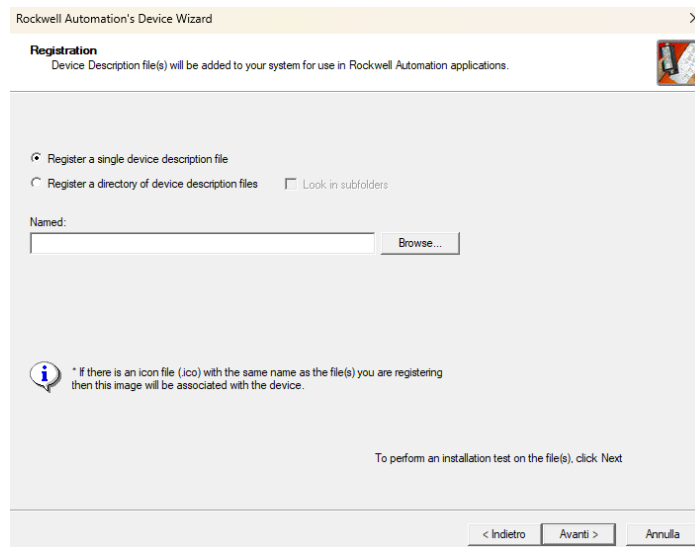

Select “Open” and then “Next”:

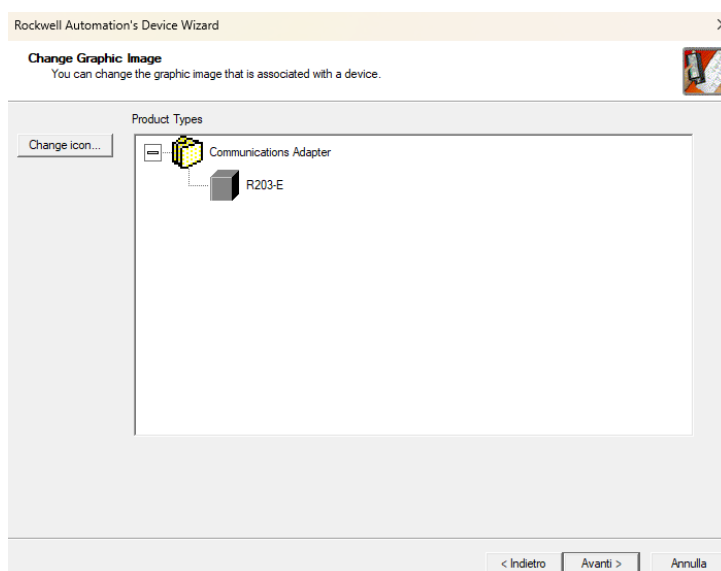
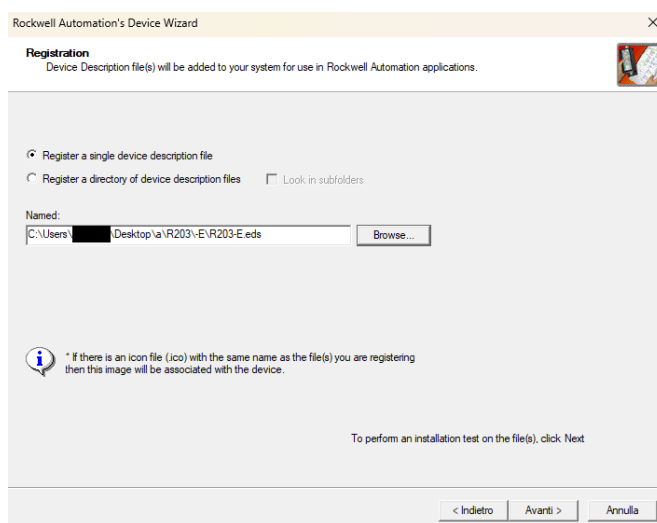

At this point the R203-E product has been entered into the device database.

Now go with the mouse over the ethernet port of the PLC connected to the device and with the right button select "New Module...":

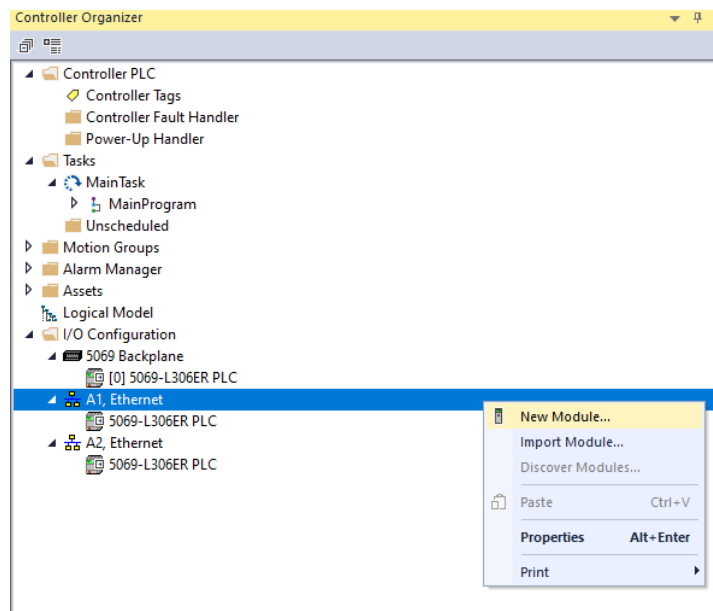

Now select the R203-E device:

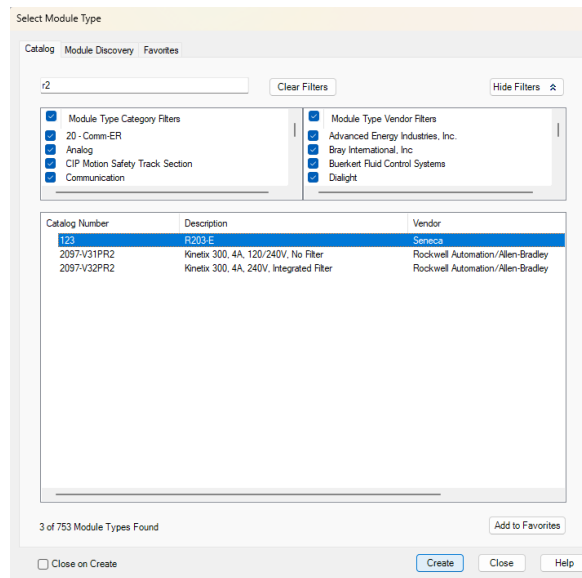

Give the device a name and enter its IP address:

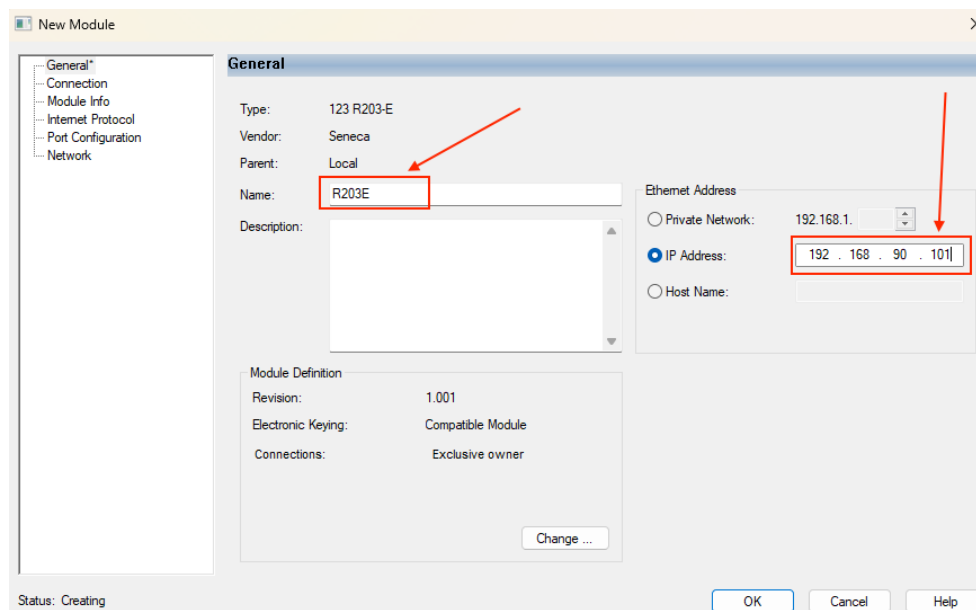

By confirming with OK the device is added:

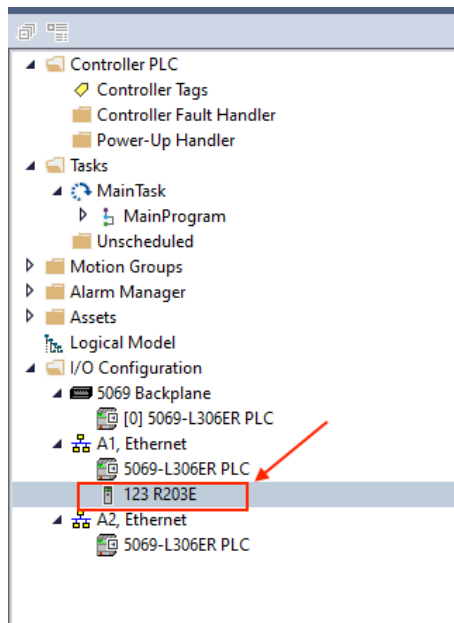

To simplify the acquisition of measurements and sending records to the device, you import the User Data Defined relating to R203-E:

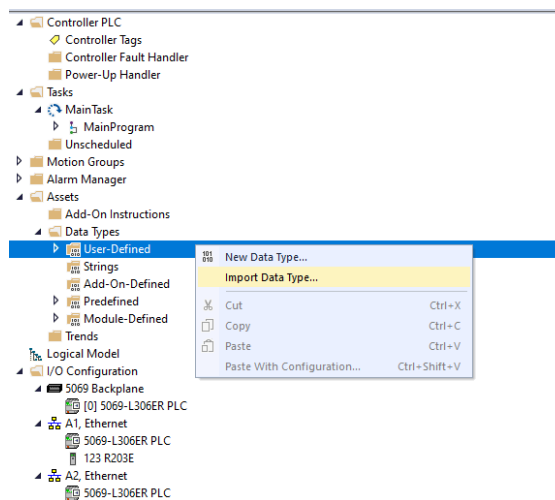

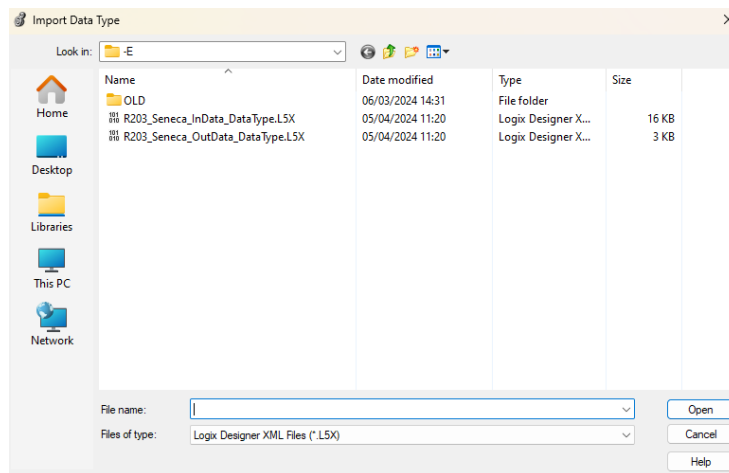

The InData will represent the measurements that come out of the device towards the PLC, OutData are the tags that allow you to send commands to the device:

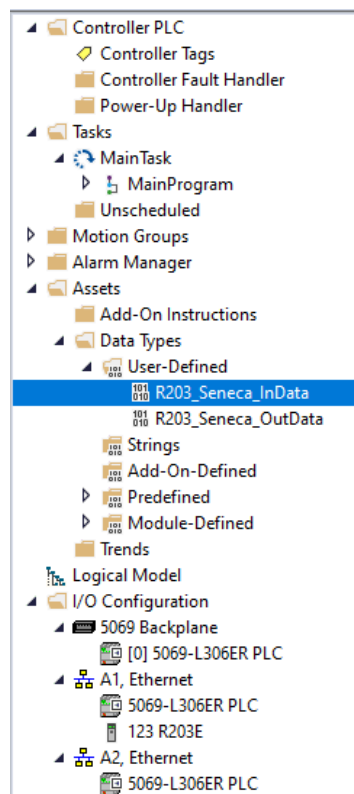

Now define the “Measurements” and “Outputs” with “R203_Seneca_InData” and “R203_Seneca_OutData” data type respectively:

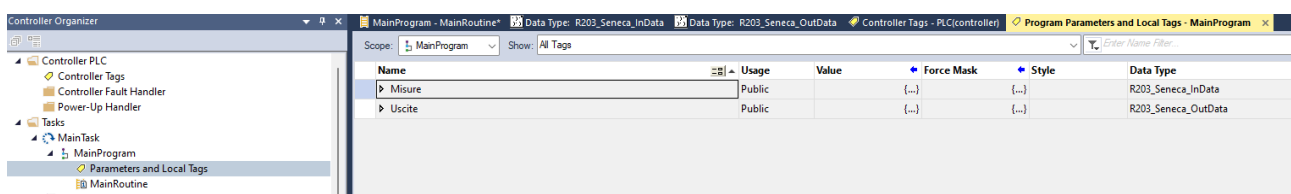

At this point define a program that copies the measurements arriving from R203 into the R203_Seneca_InData structure:

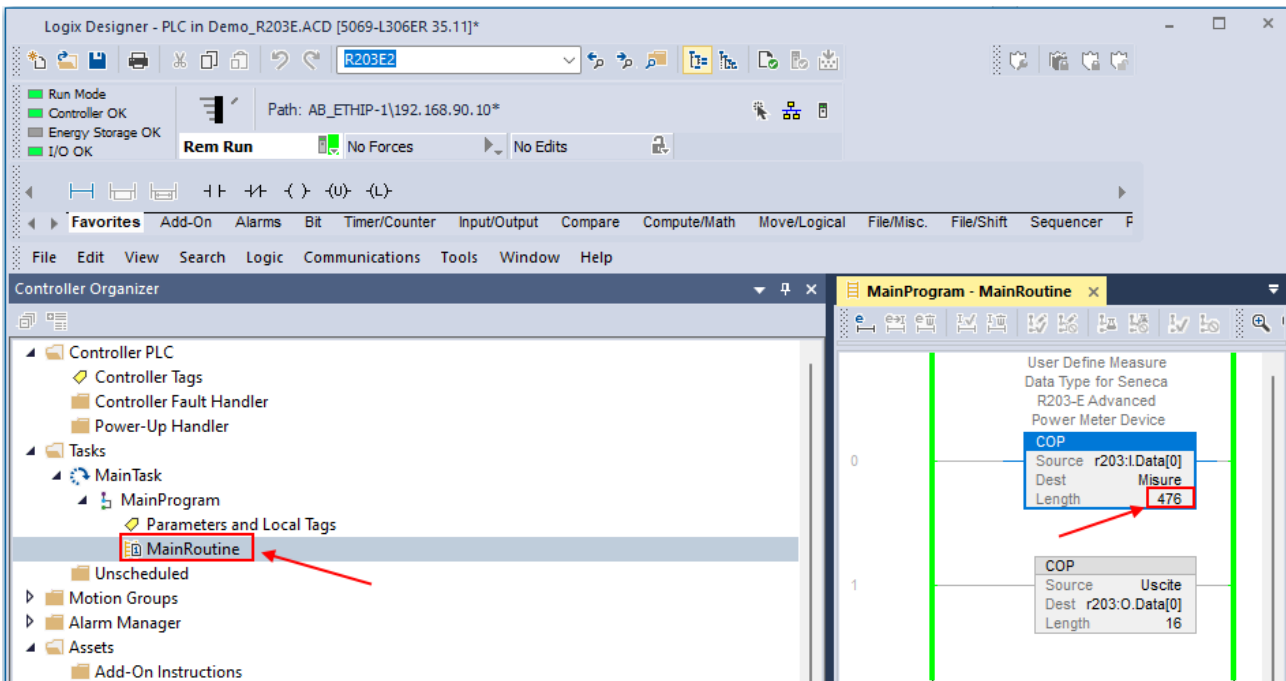

And then copy the values that you will control in the R203_Seneca_OutData structure into the data sent to the device:

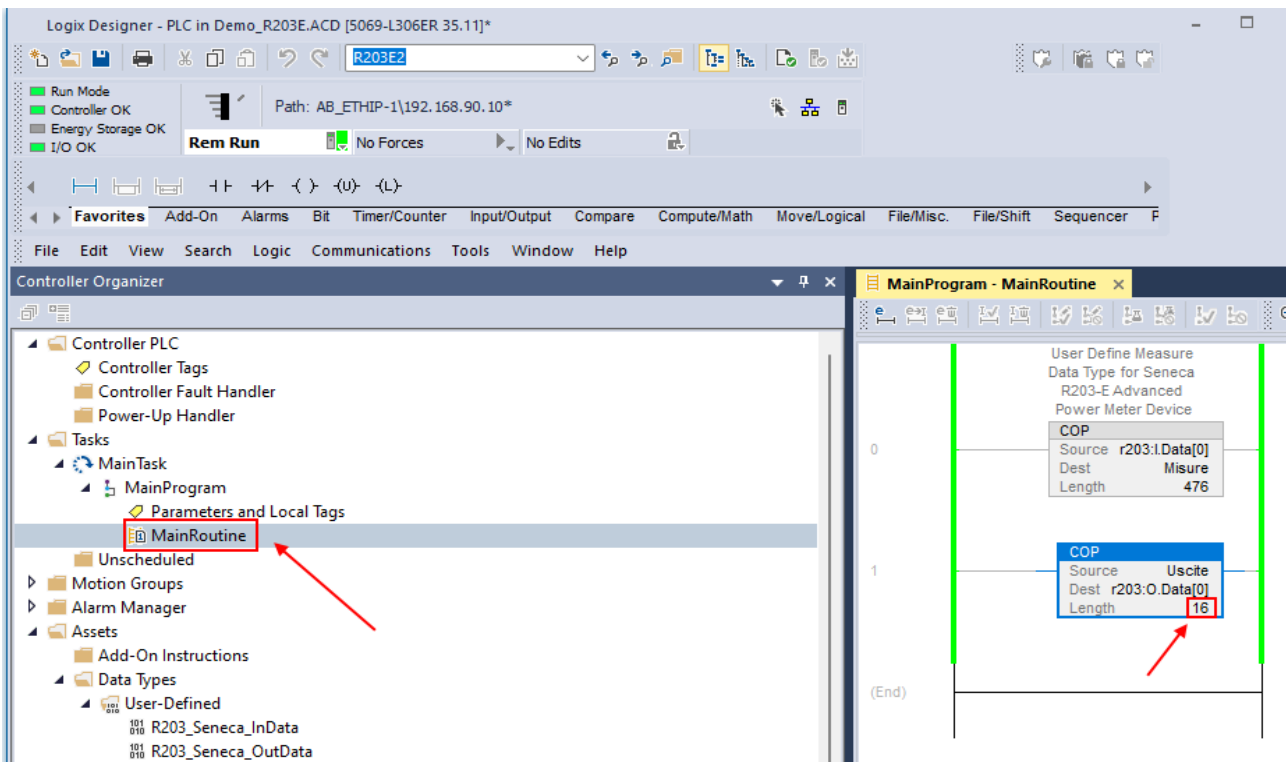

Now put the PLC in "Program" mode and download the program to the PLC.
Put the PLC in "RUN" mode and check the measurements:

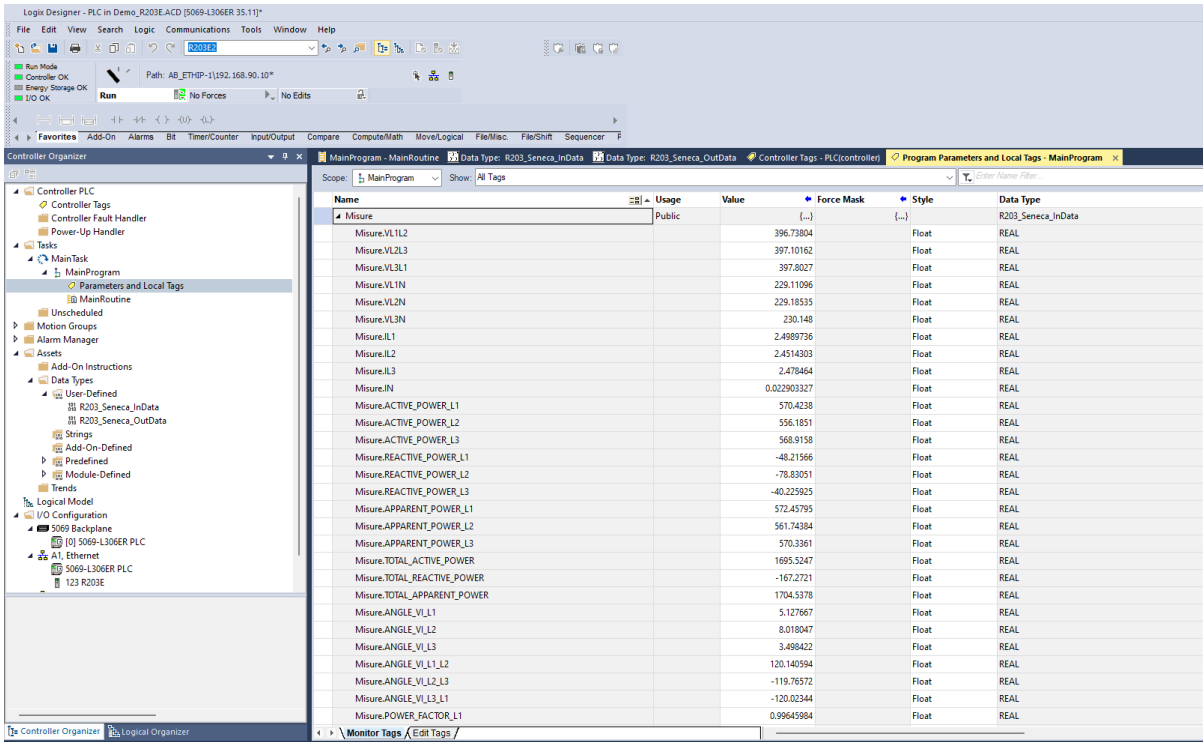

You can also control the digital outputs by activating DOUT1 for example:

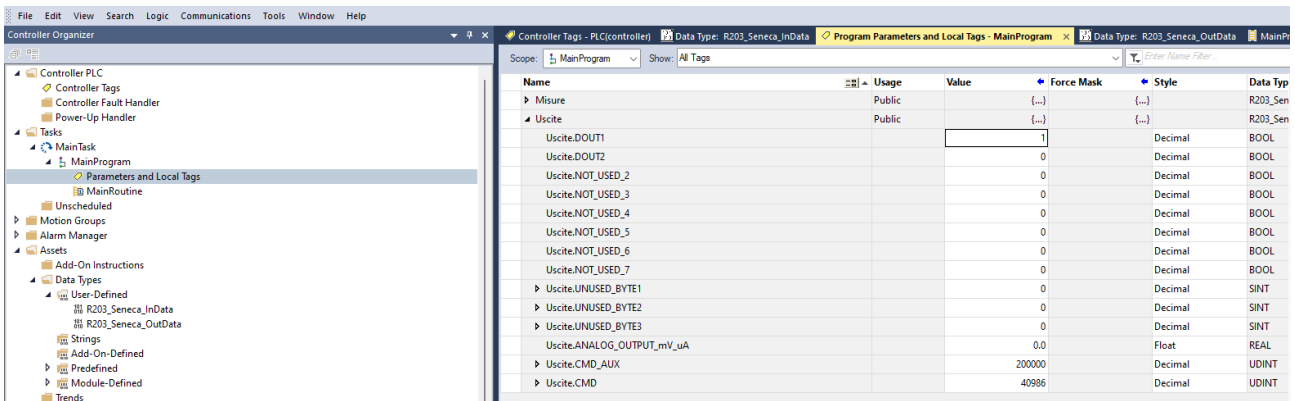

CMD and CMD AUX can be used to send commands to the device according to the following table:

COMMAND CODE(decimal)	ACTION
260	Reset MIN/MAX
259	Reset AVG
261	Reset Energy Counters
40986	Load value in CMD_AUX register to COUNTER1
41002	Load value in CMD_AUX register to COUNTER2

25. OPC-UA COMMUNICATION PROTOCOL (OPC-UA PROTOCOL MODELS ONLY)

OPC Unified Architecture (OPC UA) is a cross-platform, open source IEC62541 standard for exchanging data from sensors to cloud and SCADA applications developed by the OPC Foundation.

25.1. OPC VARIABLE NAMES

Find below the abbreviation of the OPC variable and its explanation

VARIABLE	EXPLANATION	TIPO
V1N	Voltage between Phase 1 and neutral	READ
V1N_AVG	Phase 1 to Neutral Voltage (in demand time)	READ
V1N_MIN	Minimum voltage between Phase 1 and neutral (from switch-on)	READ
V1N_MAX	Maximum voltage between Phase 1 and neutral (from switch-on)	READ
V1N_AVG_MIN	Phase 1 to minimum neutral voltage (in demand time)	READ
V1N_AVG_MAX	Phase 1 to maximum neutral voltage (in demand time)	READ
V2N	Voltage between Phase 2 and neutral	READ
V2N_AVG	Phase 2 to Neutral Voltage (in demand time)	READ
V2N_MIN	Minimum voltage between Phase 2 and neutral (from switch-on)	READ
V2N_MAX	Maximum voltage between Phase 2 and neutral (from switch-on)	READ
V2N_AVG_MIN	Phase 2 to minimum neutral voltage (in demand time)	READ
V2N_AVG_MAX	Phase 2 to maximum neutral voltage (in demand time)	READ
V3N	Voltage between Phase 3 and neutral	READ
V3N_AVG	Phase 3 to Neutral Voltage (in demand time)	READ
V3N_MIN	Minimum voltage between Phase 3 and neutral (from switch-on)	READ
V3N_MAX	Maximum voltage between Phase 3 and neutral (from switch-on)	READ
V3N_AVG_MIN	Phase 3 to minimum neutral voltage (in demand time)	READ
V3N_AVG_MAX	Phase 3 to maximum neutral voltage (in demand time)	READ
AN	Neutral Current	READ
AN_AVG	Neutral Current (on demand time)	READ
AN_MIN	Minimum neutral current (from switch-on)	READ
AN_MAX	Maximum neutral current (from switch-on)	READ
AN_AVG_MIN	Minimum neutral current (in demand time)	READ
AN_AVG_MAX	Maximum neutral current (in demand time)	READ
V12	Phase-to-phase voltage between Phase 1 and 2	READ
V12_AVG	Phase-to-phase voltage between Phase 1 and 2 (in demand time)	READ

V12_MIN	Minimum phase-to-phase voltage between Phase 1 and 2 (from switch-on)	READ
V12_MAX	Maximum phase-to-phase voltage between Phase 1 and 2 (from switch-on)	READ
V12_AVG_MIN	Phase-to-phase voltage between minimum Phase 1 and 2 (in demand time)	READ
V12_AVG_MAX	Phase-to-phase voltage between maximum Phase 1 and 2 (in demand time)	READ
V23	Phase-to-phase voltage between Phase 2 and 3	READ
V23_AVG	Phase-to-phase voltage between Phase 2 and 3 (in demand time)	READ
V23_MIN	Minimum phase-to-phase voltage between Phase 2 and 3 (from switch-on)	READ
V23_MAX	Maximum phase-to-phase voltage between Phase 2 and 3 (from switch-on)	READ
V23_AVG_MIN	Phase-to-phase voltage between minimum Phase 2 and 3 (in demand time)	READ
V23_AVG_MAX	Phase-to-phase voltage between maximum Phase 2 and 3 (in demand time)	READ
V31	Phase-to-phase voltage between Phase 3 and 1	READ
V31_AVG	Phase-to-phase voltage between Phase 3 and 1 (in demand time)	READ
V31_MIN	Minimum phase-to-phase voltage between Phase 3 and 1 (from switch-on)	READ
V31_MAX	Maximum phase-to-phase voltage between Phase 3 and 1 (from switch-on)	READ
V31_AVG_MIN	Phase-to-phase voltage between minimum Phase 3 and 1 (in demand time)	READ
V31_AVG_MAX	Phase-to-phase voltage between maximum Phase 3 and 1 (in demand time)	READ
Vsys	System voltage:	READ
Vsys_AVG	System voltage (in demand time)	READ
Vsys_MIN	Minimum system voltage (from switch-on)	READ
Vsys_MAX	Maximum system voltage (from switch-on)	READ
Vsys_AVG_MIN	Minimum system voltage (in demand time)	READ
Vsys_AVG_MAX	Maximum system voltage (in demand time)	READ
A1	Phase 1 current	READ
A1_AVG	Phase 1 current (in demand time)	READ
A1_MIN	Minimum Phase 1 current (from switch-on)	READ
A1_MAX	Maximum Phase 1 current (from switch-on)	READ
A1_AVG_MIN	Minimum Phase 1 current (in demand time)	READ
A1_AVG_MAX	Maximum Phase 1 current (in demand time)	READ
A2	Phase 2 current	READ
A2_AVG	Phase 2 current (in demand time)	READ
A2_MIN	Minimum Phase 2 current (from switch-on)	READ
A2_MAX	Maximum Phase 2 current (from switch-on)	READ

A2_AVG_MIN	Minimum Phase 2 current (in demand time)	READ
A2_AVG_MAX	Maximum Phase 2 current (in demand time)	READ
A3	Phase 3 current	READ
A3_AVG	Phase 3 current (in demand time)	READ
A3_MIN	Minimum Phase 3 current (from switch-on)	READ
A3_MAX	Maximum Phase 3 current (from switch-on)	READ
A3_AVG_MIN	Minimum Phase 3 current (in demand time)	READ
A3_AVG_MAX	Maximum Phase 3 current (in demand time)	READ
Asys	System current	READ
Asys_AVG	System current (in demand time)	READ
Asys_MIN	Minimum system current (from switch-on)	READ
Asys_MAX	Maximum system current (from switch-on)	READ
Asys_AVG_MIN	Minimum system current (in demand time)	READ
Asys_AVG_MAX	Maximum system current (in demand time)	READ
P1	Phase 1 Active power	READ
P1_AVG	Phase 1 active power (in demand time)	READ
P1_MIN	Minimum Phase 1 active power (from switch-on)	READ
P1_MAX	Maximum Phase 1 active power (from switch-on)	READ
P1_AVG_MIN	Minimum Phase 1 active power (in demand time)	READ
P1_AVG_MAX	Maximum Phase 1 active power (in demand time)	READ
P2	Phase 2 Active power	READ
P2_AVG	Phase 2 active power (in demand time)	READ
P2_MIN	Minimum Phase 2 active power (from switch-on)	READ
P2_MAX	Maximum Phase 2 active power (from switch-on)	READ
P2_AVG_MIN	Minimum Phase 2 active power (in demand time)	READ
P2_AVG_MAX	Maximum Phase 2 active power (in demand time)	READ
P3	Phase 3 Active power	READ
P3_AVG	Phase 3 active power (in demand time)	READ
P3_MIN	Minimum Phase 3 active power (from switch-on)	READ
P3_MAX	Maximum Phase 3 active power (from switch-on)	READ
P3_AVG_MIN	Minimum Phase 3 active power (in demand time)	READ
P3_AVG_MAX	Maximum Phase 3 active power (in demand time)	READ
Psys	System Active power	READ
Psys_AVG	System active power (in demand time)	READ
Psys_MIN	Minimum system active power (from switch-on)	READ
Psys_MAX	Maximum system active power (from switch-on)	READ
Psys_AVG_MIN	Minimum system active power (in demand time)	READ
Psys_AVG_MAX	Maximum system active power (in demand time)	READ
S1	Phase 1 apparent power	READ
S1_AVG	Phase 1 apparent power (in demand time)	READ
S1_MIN	Minimum Phase 1 apparent power (from switch-on)	READ
S1_MAX	Maximum Phase 1 apparent power (from switch-on)	READ
S1_AVG_MIN	Minimum Phase 1 apparent power (in demand time)	READ

S1_AVG_MAX	Maximum Phase 1 apparent power (in demand time)	READ
S2	Phase 2 apparent power	READ
S2_AVG	Phase 2 apparent power (in demand time)	READ
S2_MIN	Minimum Phase 2 apparent power (from switch-on)	READ
S2_MAX	Maximum Phase 2 apparent power (from switch-on)	READ
S2_AVG_MIN	Minimum Phase 2 apparent power (in demand time)	READ
S2_AVG_MAX	Maximum Phase 2 apparent power (in demand time)	READ
S3	Phase 3 apparent power	READ
S3_AVG	Phase 3 apparent power (in demand time)	READ
S3_MIN	Minimum Phase 3 apparent power (from switch-on)	READ
S3_MAX	Maximum Phase 3 apparent power (from switch-on)	READ
S3_AVG_MIN	Minimum Phase 3 apparent power (in demand time)	READ
S3_AVG_MAX	Maximum Phase 3 apparent power (in demand time)	READ
Ssys	System apparent power	READ
Ssys_AVG	System apparent power (in demand time)	READ
Ssys_MIN	Minimum system apparent power (from switch-on)	READ
Ssys_MAX	Maximum system apparent power (from switch-on)	READ
Ssys_AVG_MIN	Minimum system apparent power (in demand time)	READ
Ssys_AVG_MAX	Maximum system apparent power (in demand time)	READ
Q1	Phase 1 Reactive power	READ
Q1_AVG	Phase 1 reactive power (in demand time)	READ
Q1_MIN	Minimum Phase 1 reactive power (from switch-on)	READ
Q1_MAX	Maximum Phase 1 reactive power (from switch-on)	READ
Q1_AVG_MIN	Minimum Phase 1 reactive power (in demand time)	READ
Q1_AVG_MAX	Maximum Phase 1 reactive power (in demand time)	READ
Q2	Phase 2 Reactive power	READ
Q2_AVG	Phase 2 reactive power (in demand time)	READ
Q2_MIN	Minimum Phase 2 reactive power (from switch-on)	READ
Q2_MAX	Maximum Phase 2 reactive power (from switch-on)	READ
Q2_AVG_MIN	Minimum Phase 2 reactive power (in demand time)	READ
Q2_AVG_MAX	Maximum Phase 2 reactive power (in demand time)	READ
Q3	Phase 3 Reactive power	READ
Q3_AVG	Phase 3 reactive power (in demand time)	READ
Q3_MIN	Minimum Phase 3 reactive power (from switch-on)	READ
Q3_MAX	Maximum Phase 3 reactive power (from switch-on)	READ
Q3_AVG_MIN	Minimum Phase 3 reactive power (in demand time)	READ
Q3_AVG_MAX	Maximum Phase 3 reactive power (in demand time)	READ
Qsys	System Reactive power	READ
Qsys_AVG	System reactive power (in demand time)	READ
Qsys_MIN	Minimum system reactive power (from switch-on)	READ
Qsys_MAX	Maximum system reactive power (from switch-on)	READ
Qsys_AVG_MIN	Minimum system reactive power (in demand time)	READ
Qsys_AVG_MAX	Maximum system reactive power (in demand time)	READ

TPF1	Phase 1 Power factor	READ
TPF1_AVG	Phase 1 power factor (in demand time)	READ
TPF1_MIN	Minimum Phase 1 power factor (from switch-on)	READ
TPF1_MAX	Maximum Phase 1 power factor (from switch-on)	READ
TPF1_AVG_MIN	Minimum Phase 1 power factor (in demand time)	READ
TPF1_AVG_MAX	Maximum Phase 1 power factor (in demand time)	READ
TPF2	Phase 2 Power factor	READ
TPF2_AVG	Phase 2 power factor (in demand time)	READ
TPF2_MIN	Minimum Phase 2 power factor (from switch-on)	READ
TPF2_MAX	Maximum Phase 2 power factor (from switch-on)	READ
TPF2_AVG_MIN	Minimum Phase 2 power factor (in demand time)	READ
TPF2_AVG_MAX	Maximum Phase 2 power factor (in demand time)	READ
TPF3	Phase 3 Power factor	READ
TPF3_AVG	Phase 3 power factor (in demand time)	READ
TPF3_MIN	Minimum Phase 3 power factor (from switch-on)	READ
TPF3_MAX	Maximum Phase 3 power factor (from switch-on)	READ
TPF3_AVG_MIN	Minimum Phase 3 power factor (in demand time)	READ
TPF3_AVG_MAX	Maximum Phase 3 power factor (in demand time)	READ
TPFsys	System Power factor	READ
TPFsys_AVG	System power factor (in demand time)	READ
TPFsys_MIN	Minimum system power factor (from switch-on)	READ
TPFsys_MAX	Minimum system power factor (from switch-on)	READ
TPFsys_AVG_MIN	Minimum system power factor (in demand time)	READ
TPFsys_AVG_MAX	Maximum system power factor (in demand time)	READ
THD-V1N	Voltage THD (Total Harmonic Distortion) between Phase 1 and neutral	READ
THD-V1N_AVG	Voltage THD between Phase 1 and neutral (in demand time)	READ
THD-V1N_MIN	Minimum voltage THD between Phase 1 and neutral (from switch-on)	READ
THD-V1N_MAX	Maximum voltage THD between Phase 1 and neutral (from switch-on)	READ
THD-V1N_AVG_MIN	Minimum voltage THD between Phase 1 and neutral (in demand time)	READ
THD-V1N_AVG_MAX	Maximum voltage THD between Phase 1 and neutral (in demand time)	READ
THD-V2N	Voltage THD between Phase 2 and neutral	READ
THD-V2N_AVG	Voltage THD between Phase 2 and neutral (in demand time)	READ
THD-V2N_MIN	Minimum voltage THD between Phase 2 and neutral (from switch-on)	READ
THD-V2N_MAX	Maximum voltage THD between Phase 2 and neutral (from switch-on)	READ
THD-V2N_AVG_MIN	Minimum voltage THD between Phase 2 and neutral (in demand time)	READ
THD-V2N_AVG_MAX	Maximum voltage THD between Phase 2 and neutral (in demand time)	READ

THD-V3N	Voltage THD between Phase 3 and neutral	READ
THD-V3N_AVG	Voltage THD between Phase 3 and neutral (in demand time)	READ
THD-V3N_MIN	Minimum voltage THD between Phase 3 and neutral (from switch-on)	READ
THD-V3N_MAX	Maximum voltage THD between Phase 3 and neutral (from switch-on)	READ
THD-V3N_AVG_MIN	Minimum voltage THD between Phase 3 and neutral (in demand time)	READ
THD-V3N_AVG_MAX	Maximum voltage THD between Phase 3 and neutral (in demand time)	READ
f	Phase frequency (read from Phase 1)	READ
THD-A1N	Phase 1 current THD	READ
THD-A1N_AVG	Phase 1 current THD (in demand time)	READ
THD-A1N_MIN	Minimum Phase 1 current THD (from switch-on)	READ
THD-A1N_MAX	Maximum Phase 1 current THD (from switch-on)	READ
THD-A1N_AVG_MIN	Minimum Phase 1 current THD (in demand time)	READ
THD-A1N_AVG_MAX	Maximum Phase 1 current THD (in demand time)	READ
THD-A2N	Phase 2 current THD	READ
THD-A2N_AVG	Phase 2 current THD (in demand time)	READ
THD-A2N_MIN	Minimum Phase 2 current THD (from switch-on)	READ
THD-A2N_MAX	Maximum Phase 2 current THD (from switch-on)	READ
THD-A2N_AVG_MIN	Minimum Phase 2 current THD (in demand time)	READ
THD-A2N_AVG_MAX	Maximum Phase 2 current THD (in demand time)	READ
THD-A3N	Phase 3 current THD	READ
THD-A3N_AVG	Phase 3 current THD (in demand time)	READ
THD-A3N_MIN	Minimum Phase 3 current THD (from switch-on)	READ
THD-A3N_MAX	Maximum Phase 3 current THD (from switch-on)	READ
THD-A3N_AVG_MIN	Minimum Phase 3 current THD (in demand time)	READ
THD-A3N_AVG_MAX	Maximum Phase 3 current THD (in demand time)	READ
+WH1	Phase 1 positive active energy	READ
+WH2	Phase 2 positive active energy	READ
+WH3	Phase 3 positive active energy	READ
+Wh	Total positive active energy	READ
-WH1	Phase 1 negative active energy	READ
-WH2	Phase 2 negative active energy	READ
-WH3	Phase 3 negative active energy	READ
-Wh	Total negative active energy	READ
VAh1	Phase 1 apparent energy	READ
VAh2	Phase 2 apparent energy	READ

VAh3	Phase 3 apparent energy	READ
VAh	Total apparent energy	READ
+VARh1-L[Q1]	Phase 1 positive inductive reactive energy (Q1)	READ
+VARh2-L[Q1]	Phase 2 positive inductive reactive energy (Q1)	READ
+VARh3-L[Q1]	Phase 3 positive inductive reactive energy (Q1)	READ
+VARh-L[Q1]	Total positive inductive reactive energy (Q1)	READ
-VARh1-C[Q4]	Phase 1 negative capacitive reactive energy (Q4)	READ
-VARh2-C[Q4]	Phase 2 negative capacitive reactive energy (Q4)	READ
-VARh3-C[Q4]	Phase 3 negative capacitive reactive energy (Q4)	READ
-VARh-C[Q4]	Total negative capacitive reactive energy (Q4)	READ
-VARh1-L[Q3]	Phase 1 negative inductive reactive energy (Q3)	READ
-VARh2-L[Q3]	Phase 2 negative inductive reactive energy (Q3)	READ
-VARh3-L[Q3]	Phase 3 negative inductive reactive energy (Q3)	READ
-VARh-L[Q3]	Total negative inductive reactive energy (Q3)	READ
+VARh1-C[Q2]	Phase 1 positive capacitive reactive energy (Q2)	READ
+VARh2-C[Q2]	Phase 2 positive capacitive reactive energy (Q2)	READ
+VARh3-C[Q2]	Phase 3 positive capacitive reactive energy (Q2)	READ
+VARh-C[Q2]	Total positive capacitive reactive energy (Q2)	READ
Wh	Total active energy	READ
VARh	Total reactive energy	READ
VARh-L[Q1Q3]	Total inductive reactive energy (Q1+Q3)	READ
VARh-C[Q2Q4]	Total capacitive reactive energy (Q2+Q4)	READ
VAh	Total apparent energy	READ
COUNTER 1	Input 1 pulse counter	READ
COUNTER 2	Input 2 pulse counter	READ
DIGITAL_IN_1	Digital Input 1	READ
DIGITAL_IN_2	Digital Input 2	READ
DIGITAL_OUT_1	Digital output 1	READ/ WRITE
DIGITAL_OUT_2	Digital output 2	READ/ WRITE
ANALOG OUT	Value to load on analog output (R203 models only) in uA or mV	READ/ WRITE
COMMAND	Command register. Supported commands: 260 decimal to reset MIN/MAX 259 decimal to reset AVG demand time values 261 decimal to reset Energy Counters	READ/ WRITE
TOT KVARh L1	Phase 1 total reactive energy	READ
TOT KVARh L2	Phase 2 total reactive energy	READ
TOT KVARh L3	Phase 3 total reactive energy	READ
STATUS	Device status bit BIT0 -> Cyclic phase sense error (1 ERR, 0 OK) BIT1 -> ALARM (1 ACTIVE, 0 NOT ACTIVE) BIT2 -> DOUT1 status (1 ACTIVE, 0 NOT ACTIVE) BIT3 -> DOUT2 status (1 ACTIVE, 0 NOT ACTIVE) BIT4 -> DIN1 STATUS (1 high, 0 low) BIT5 -> DIN2 STATUS (1 high, 0 low)	READ

	BIT6 -> Current Cutoff (1 active, 0 inactive) BIT 7 -> Current error L1 (1 CT connected reverse, 0 CT connected OK) BIT 8 -> Current error L2 (1 CT connected reverse, 0 CT connected OK) BIT 9 -> Current error L3 (1 CT connected inverted, 0 CT connected OK) BIT 10 -> Line 1 Voltage/Current connection error (1 Error, 0 OK) BIT 11 -> Connection error Line 2 Voltage/Current (1 Error, 0 OK) BIT 12 -> Connection error Line 3 Voltage/Current (1 Error, 0 OK)	
Wh1	Phase 1 total active energy	READ
Wh2	Phase 2 total active energy	READ
Wh3	Phase 3 total active energy	READ

25.2. UaEXPERT™ CLIENT CONFIGURATION

To perform a test connection, use the UaExpert™ software.

UaExpert™ is a complete OPC UA client capable of supporting different OPC UA profiles and features.

The free version can be downloaded from the link:

<https://www.unified-automation.com/downloads.html>

First, configure the OPC-UA server parameters in the webserver of the device (OPC-UA settings section):

OPC-UA SETTING		
SERVER NAME	R203	<input type="text" value="R203"/>
SERVER PORT	4840	<input type="text" value="4840"/>
AUTHENTICATION	OFF	<input type="button" value="ON"/> ▾
USERNAME	admin	<input type="text" value="admin"/>
PASSWORD	admin	<input type="text" value="admin"/>
OPC-UA SERVER SECURITY POLICY	NONE	<input type="button" value="AES128SHA256RSAOAEP"/> ▾
OPC-UA SERVER MESSAGE SECURITY MODE	SIGN AND ENCRYPT	<input type="button" value="SIGN AND ENCRYPT"/> ▾

In this way you have activated the indicated security policy.

Use certificates by default.

Now open the OPC-UA client and press the “+” icon to add an OPC-UA server:

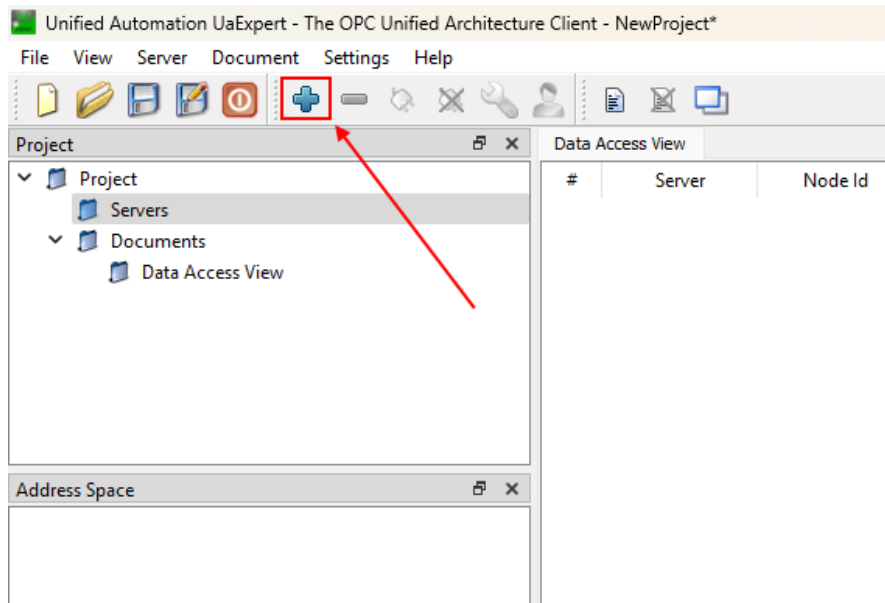

At this point under "Custom directory" we enter the IP address of the device (192.168.90.101 in the example) and the configured port (4840 in the example):

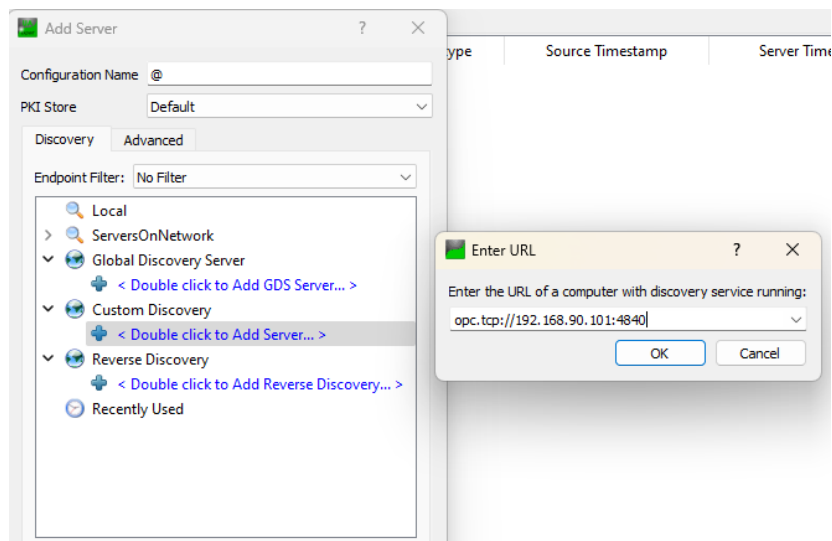

By pressing OK the server is added to the list, select the desired encryption:

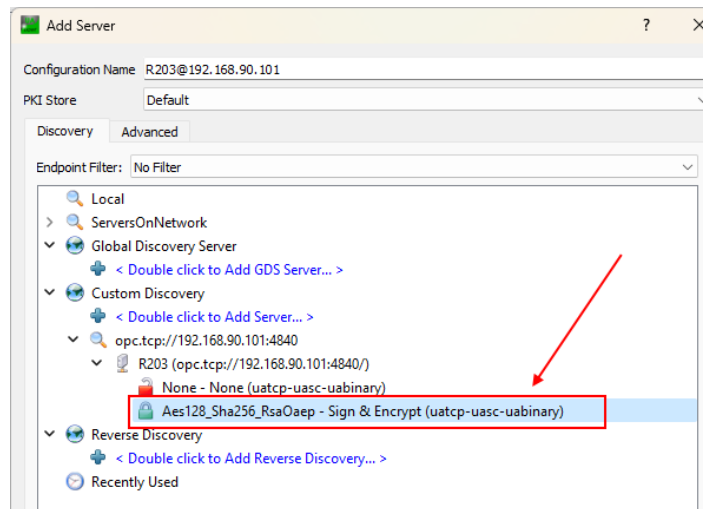

Press OK

Now the server is added.

First select the server and then press the connection icon:

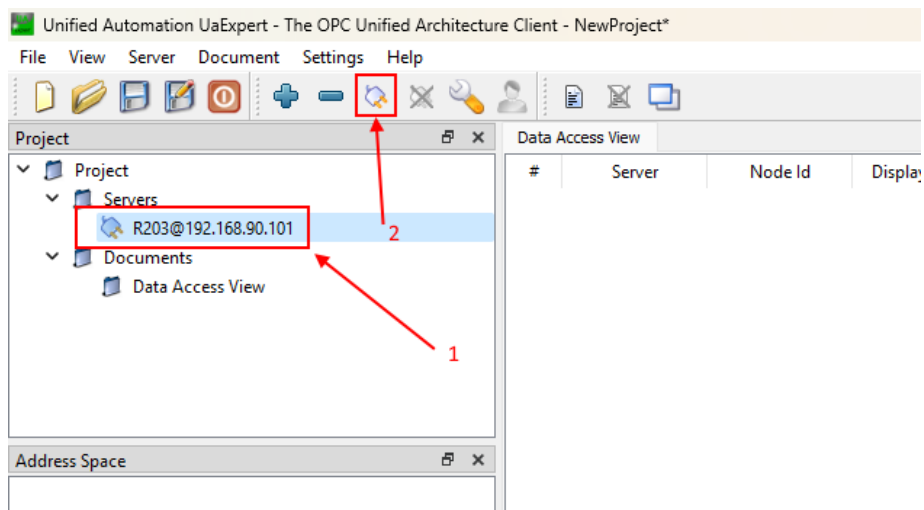

You will be asked for your credentials as configured:

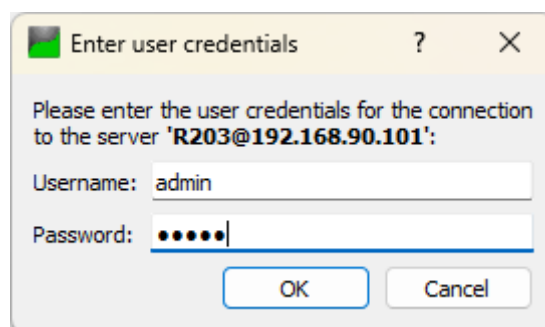

At this point a screen will appear indicating that the certificate is not secure:

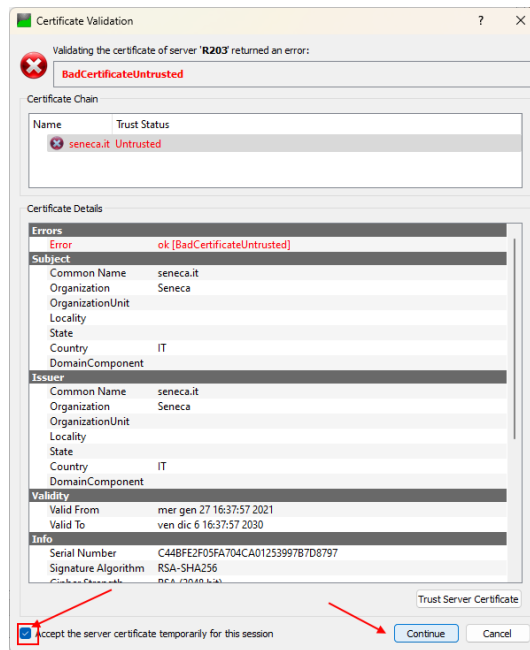

Accept the certificate and press the “Continue” button.

Now ignore the next two certificate-related errors:

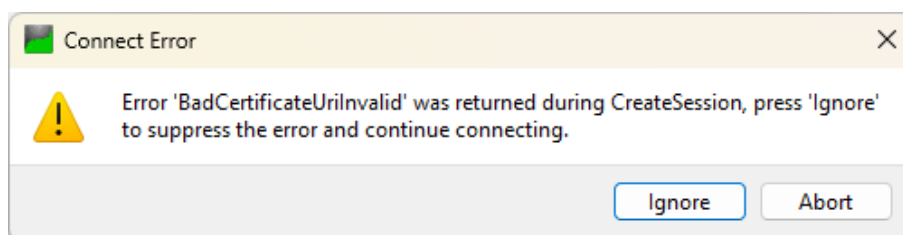
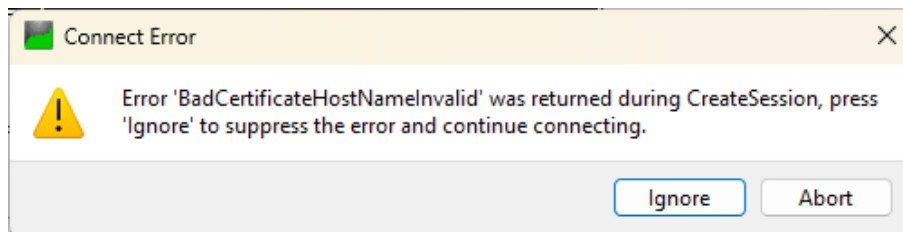

Now the connection is established and the configured list of variables appears:

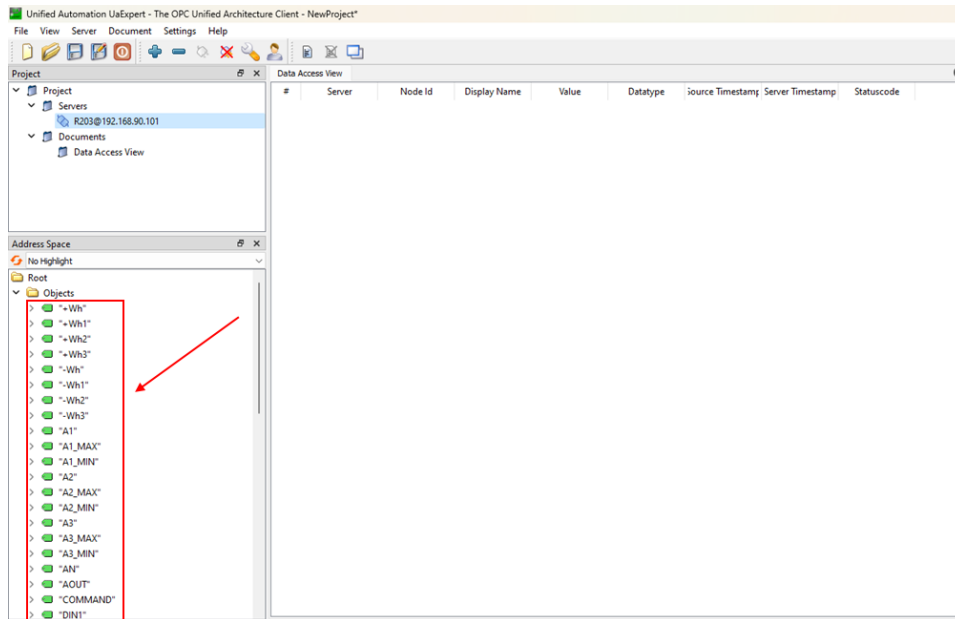

Now you can drag the variables you want to view:

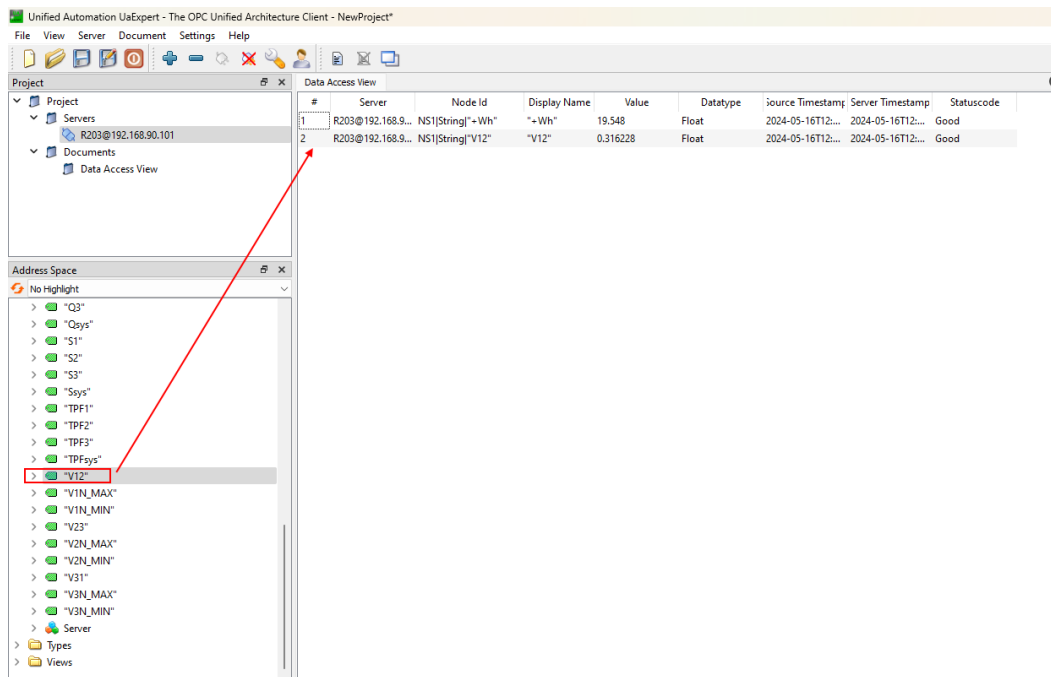

It is also possible to write on the variables in read/write mode, for example it is possible to activate the digital output DOUT2 by writing the value to 1:

Data Access View								
#	Server	Node Id	Display Name	Value	Datatype	Source Timestamp	Server Timestamp	Statuscode
1	R203@192.168.9...	NS1[String]"Wh"	"Wh"	19.548	Float	2024-05-16T12:...	2024-05-16T12:...	Good
2	R203@192.168.9...	NS1[String]"V12"	"V12"	0.316228	Float	2024-05-16T12:...	2024-05-16T12:...	Good
3	R203@192.168.9...	NS1[String]"DOUT1"	"DOUT1"	0	Byte	2024-05-16T12:...	2024-05-16T12:...	Good
4	R203@192.168.9...	NS1[String]"DOUT2"	"DOUT2"	1	Byte	2024-05-16T12:...	2024-05-16T12:...	Good