





INSTALLATION MANUAL

VPN BOX CLOUD BOX

PRELIMINARY WARNINGS

The word **WARNING** preceded by the symbol  indicates conditions or actions that put the user's safety at risk. The word **ATTENTION** preceded by the symbol  indicates conditions or actions that might damage the instrument or the connected equipment. The warranty shall become null and void in the event of improper use or tampering with the module or devices supplied by the manufacturer as necessary for its correct operation, and if the instructions contained in this manual are not followed.

	WARNING: The full content of this manual must be read before any operation. The module must only be used by qualified electricians. Specific documentation is available via QR-CODE shown on page 1.
	The module must be repaired and damaged parts replaced by the Manufacturer. The product is sensitive to electrostatic discharges. Take appropriate measures during any operation.
	Electrical and electronic waste disposal (applicable in the European Union and other countries with recycling). The symbol on the product or its packaging shows the product must be surrendered to a collection centre authorized to recycle electrical and electronic waste.



DOCUMENTATION
Z-KEY



DOCUMENTATION
Z-KEY-P



SENECA s.r.l.; Via Austria, 26 – 35127 – PADOVA – ITALY; Tel. +39.049.8705359 - Fax +39.049.8706287

CONTACT INFORMATION

Technical support	support@seneca.it	Product information	sales@seneca.it
-------------------	-------------------	---------------------	-----------------

This document is the property of SENECA srl. Copies and reproduction are prohibited unless authorised. The content of this document corresponds to the described products and technologies. Stated data may be modified or supplemented for technical and/or sales purposes.

MODULE LAYOUT

FRONT PANEL

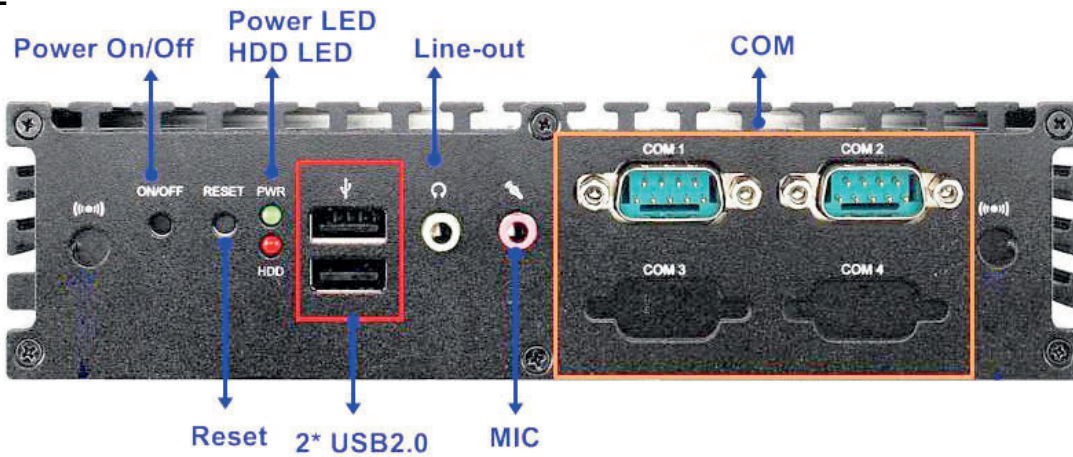

REAR PANEL

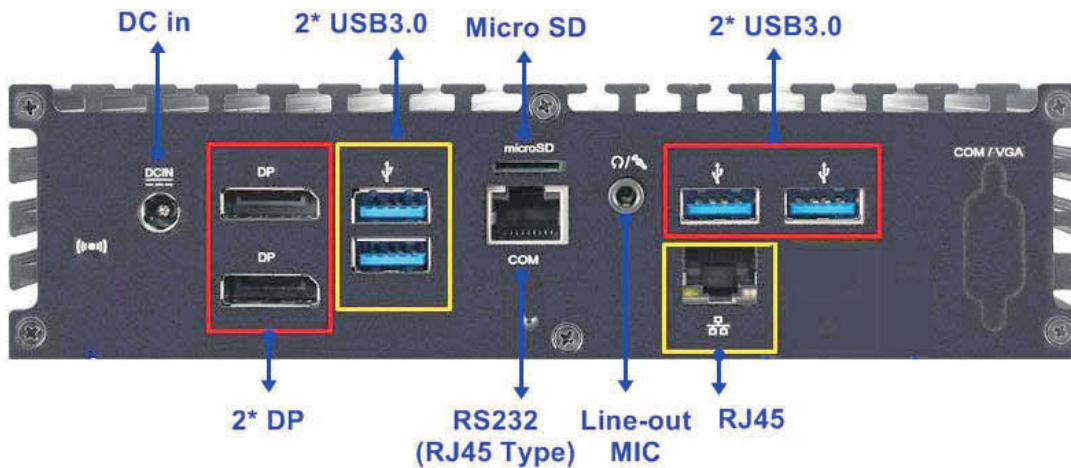



Dimensions: 185 x 142 x 48 mm, Net weight: 1.3kg

GENERAL FEATURES

PROCESSOR	Intel Apollo Lake SoC Processor - INTEL CELERON J3455 @1.5GHz Clock: 1.50GHz;; Turbo Speed: 2.30GHz
CORE NUMBER.	Core: 4
COOLING	Fanless
MEMORY	DDR3 SO-DIMM by 4GB @ 1600MHz
HARD DISK.	SSD M.2 da 128GB
POWER INPUT	Onboard DC jack
CASE	Compact Fanless

TECHNICAL SPECIFICATIONS

CERTIFICATIONS	   https://www.seneca.it/products/vpn-box/doc/CE_declaration https://www.seneca.it/products/cloud-box/doc/CE_declaration
CERTIFICATIONS	5A; 60W max.
ENVIRONMENTAL CONDITIONS	<i>Temperature: 0°C – +50°C; Humidity: 30% – 90% non condensing.</i> <i>Altitude: Up to 2000 m above sea level.</i> <i>Storage temperature: -10 °C – + 70 °C; Protection rating: IP20</i>
IP ADDRESS OF FACTORY	The default IP address is configured in DHCP

Programming tools, app, manuals, templates, examples, etc. for the product can be downloaded free of charged at www.seneca.it in the product section.