

INSTALLATION MANUAL

Z-LOGGER3

Datalogger with built-in I/O, telecontrol functions
and advanced programming language

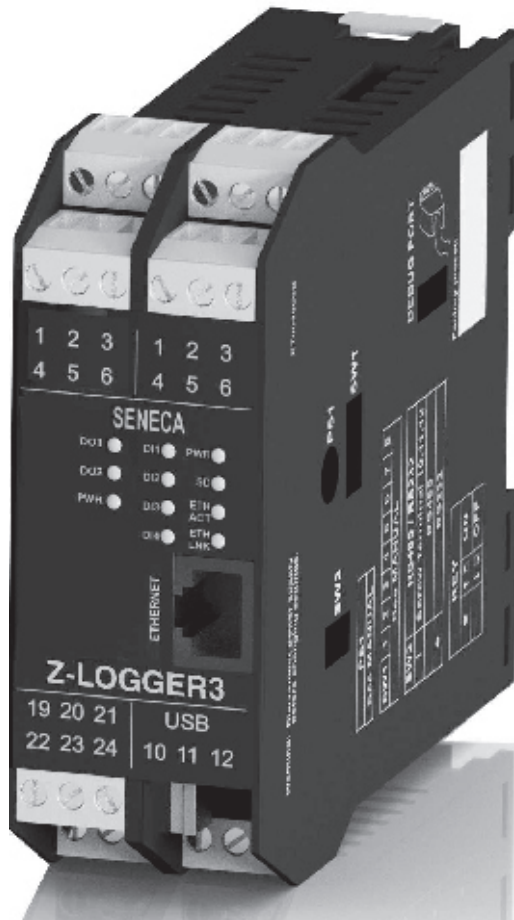

SENECA s.r.l.

Headquarters: Via Austria, 26 – 35127 – PADOVA – ITALY

Phone +39.049.8705355 - 8705359 - Fax +39.049.8706287

Manuals and configuration software are available at website: www.seneca.it/products/z-logger3

This document is property of SENECA Srl. Duplication and reproduction are forbidden, if not authorized. Contents of the present documentation refers to products and technologies described in it. This informations may be modified or integrated for technical and / or commercial requirements.

TECHNICAL SPECIFICATIONS

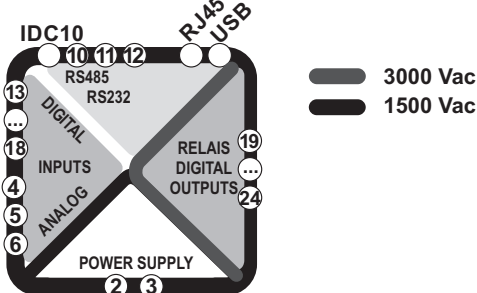
STANDARDS	EN61000-6-4 Electromagnetic emission, industrial environment EN61000-6-2 .Electromagnetic immunity, industrial environment. EN61010-1 Safety.
INSULATION	
ENVIRONMENTAL CONDITIONS <i>Temperature</i> <i>Humidity</i> <i>Storage temperature</i> <i>Protection rating</i>	-10 – + 50°C / (-10 – + 40°C with internal UPS use). 30% – 90% not condensing. -20 – + 65°C / (-20 – + 45°C < 6 months with internal UPS use). IP20.
MOUNTING	35mm IEC EN60715 DIN Rail.
INTERNAL UPS	Backup rechargeable batteries. Duration: up to 1 hour.
CONNECTIONS	Removable three pole screw terminal pitch 5mm, for cable up to 2.5 mm ² , rear IDC10, front RJ45 and Micro USB.
POWERSUPPLY <i>Voltage</i> <i>Power absorbed</i>	11 – 40 Vdc or 19 – 28 Vac 50 – 60 Hz. 4 W.
DIGITAL INPUTS	Number of channels 4. PNP or NPN configurable. Input voltage OFF<4V ON>8V (Max. 24Vd). Input current 20mA. Max. frequency 30Hz. Absorbed Current 3mA at 12Vdc 10mA at 24Vdc.
TOTALIZERS	32 bit totalizers 4x on non-volatile memory.
COUNTERS	32 bit resettable counters 4x on non-volatile memory.
DIGITAL OUTPUTS	Number of channels 2. SPDT Relays with free contacts. Max. Voltage 250Vac. Max. Current 2A.
ANALOG INPUTS	Number of channels 2. mAdc or Vdc configurable. Voltage input 0 – 30V. accuracy 0.1% of the Full Scale, impedance 200 kohm. Current input 0 – 20mA accuracy 0.1% of the Full Scale, impedance < 60 ohm. Inputs protection 40V / 25mA. Resolution 16 bit.
COMMUNICATION PORTS	Rear RS485 COM1 port. RS485 or RS232 M10-M11-M12 COM2 screw terminals port. Ethernet 100 baseT RJ45 frontal port. MicroUSB side port.





TECHNICAL SPECIFICATIONS

SUPPORTED SYSTEM PROTOCOLS	FTP client,SMTP client, http, ModBUS TCP server, ModBUS TCP client, ModBUS RTU master, ModBUS RTU slave. For more information, please refer to the User Manual .
STORAGE UNIT	microSD and microSDHC Max. 32GB.
PROCESSOR	ARM 32bit
OPERATING SYSTEM	Real Time Multitasking
CHARACTERISTICS	Embedded Webserver and microSD Webserver

MODULE SHUT DOWN PROCEDURE

The module has an internal UPS that allows it to remain turned ON even without external power supply. To turn off the module after removing the external power supply you can press the button PS1 on the right side of the module for at least 10 seconds. When you release the button the PWR LED turns OFF in order to signal that the module is switched off.

PRELIMINARY WARNINGS

	Before performing any operation is mandatory to read the full contents of this manual. The module may only be used by qualified and skilled technicians in the field of electric installation. Specific documentation is available for download at website: www.seneca.it/products/z-logger3
	Only the Manufacturer is authorized to repair the module or to replace damaged parts. The product is susceptible to electrostatic discharge, take appropriate countermeasures during any operation.
	No warranty is guaranteed in connection with faults resulting from improper use, from modifications or repairs carried out by Manufacturer-unauthorized personnel on the device, or if the content of this user Manual is not followed.
	It is forbidden to place anything that could obstruct the ventilation slits. It is forbidden to install the module near heat sources.
	Disposal of electrical & electronic equipment (applicable throughout the EU and other countries with separate collection programs). The symbol found on this product or on its packaging, indicates that this product it must be handed over to an applicable collection point for the recycling of electrical and electronic equipments.

INSTALLATION ON AND REMOVAL FROM IEC EN 60715 DIN RAIL

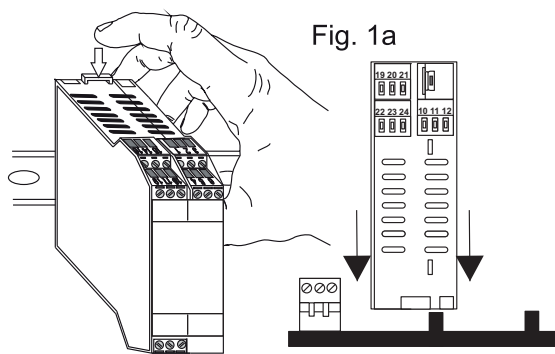

Fig. 1a

Insertion on the IEC EN 60715 DIN rail:

- 1) Move the two hooks on the back of the module outwards as illustrated in fig. 1b.
- 2) Insert the module rear IDC10 connector into a free slot of DIN rail accessory as you can see in fig 1a. (the insertion is one way only because the connectors are polarized).
- 3) To secure the module to the IEC EN 60715 DIN rail, tighten the two hooks on the side of the IDC10 rear connector as shown in fig. 1a.

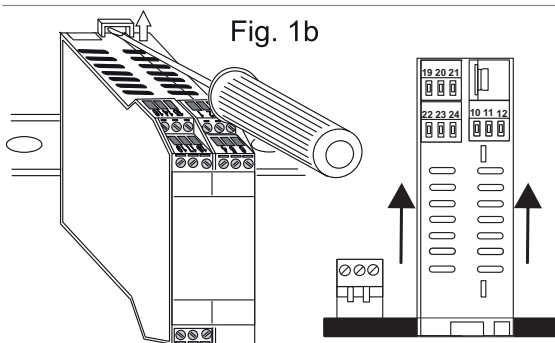

Fig. 1b

Removal from IEC EN 60715 DIN rail:

As shown in fig. 1b:

- 1) Move outwards the two hooks on the side of the module, with the help of a screwdriver.
- 2) Extract the module from the IEC EN 60715 DIN rail.

USE OF Z-PC-DINAL ACCESSORY

Don't turn upside down the module and **don't force the insertion** of the IDC10 connector into the Z-PC-DIN bus. The IDC10 connector located on the rear of the module will be inserted on a free slot of Z-PC-DIN accessory. In the figure you can see the meaning of the various pins of the rear IDC10 connector if you want to provide the signals directly through this connector. The pictures **Fig. 1 c** and **Fig.1 d** show how to connect powersupply and RS485 COM1 port to the rear IDC10 connector.

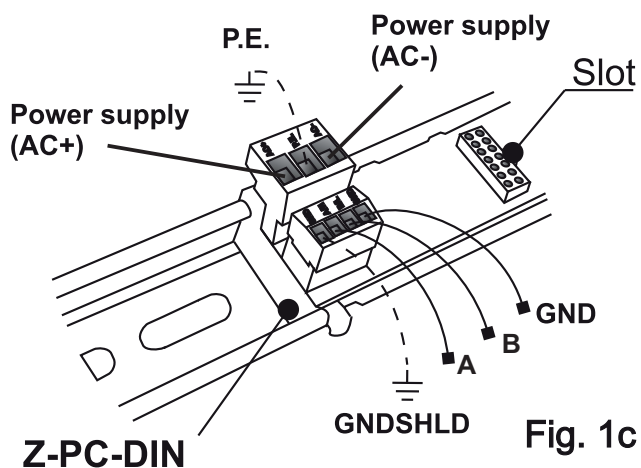

Fig. 1c

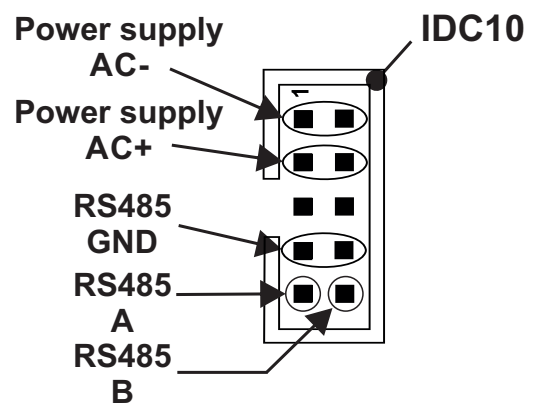

Fig. 1d

ELECTRICAL CONNECTIONS



Warning: When you turn On the module for the first time, the device must be supplied without any interruptions for at least 72 hours in order to charge the internal batteries
Power off the module, with the PS1 button, before connecting the inputs and outputs.

In order to satisfy the electromagnetic compliance requirements:

- Use shielded cables for the signals transmission.
- Connect the shield to a preferential ground for devices.
- Space the shielded cables from other cables used for power installations. (transformers, inverters, motors, induction ovens, etc...).

• POWERSUPPLY

19 – 28Vac 50 – 60 Hz 11 – 40Vdc 4 W	The power supply must be connected to terminals 2 and 3. The supply voltage must be between: 11 and 40 Vdc (any polarity), or between 19 and 28 Vac.
	The upper limits must not be exceeded in order to avoid serious damage to the module. The power supply source must be protected from any malfunctions of the module through appropriately sized safety fuse.

• TWO ANALOG INPUTS

Voltage	Current active sensor (4 wires)	Current passive sensor (2 wires)	The module has two software voltage or current configurable analog inputs. For the configuration software you can read the user manual.
		<p>(*) Not available without external powersupply</p>	

• FOUR DIGITAL INPUTS

Internal power supply NPN	Internal power supply PNP	External power supply PNP

• TWO DIGITAL OUTPUTS

N.A.1=19 CO.1=20 N.C.1=21		N.A.2=22 CO.2=23 N.C.2=24		The module has two digital outputs with free contacts . The figures show the internal relay contacts available.
---------------------------------	--	---------------------------------	--	--

• COM2 SERIAL PORT

	RS485 SERIAL PORT (SW2=OFF↓)		RS232 SERIAL PORT (SW2=ON↑)	The module has a serial port available to terminals 10-11-12. You can configure this port through SW2 switch.
--	--	--	---------------------------------------	---

SD-CARD INSERTING

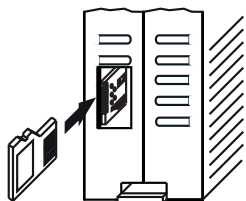

Inserting the MicroSD or the microSDHC, into the side slot. Max 32 GB.
Push-push connector for microSD card insertion and removal.

RJ45 ETHERNET AND USB CONNECTIONS

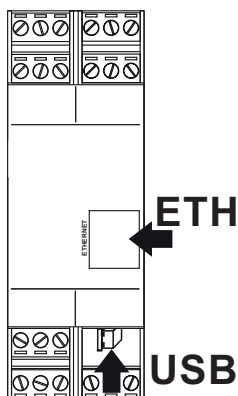

The module has a RJ45 socket on frontal panel.



Note: Inserting the RJ45 10/100 Base T Ethernet plug make sure that the connector is securely latched, or before inserting the cable into the RJ45 connector, move the protective rubber. The picture shows how to Insert the RJ45 connector. For further information, refer to the **USER MANUAL**.

The module has a serial USB micro port on the lower side.

The picture shows how to Insert the micro USB plug into the micro USB side socket. For further information, refer to the **USER MANUAL**.

CONFIGURATIONS

DIP-SWITCHES

SW1	All the DIP-Switches to OFF  ↓ position. For further informations please refer to: USER MANUAL		
SW2	RS232 or RS485 configuration on terminals 10-11-12 (serial port COM 2)		
	RS232	ON	 ↑
	RS485	OFF	 ↓

ORDER CODES

Code	Description
Z-LOGGER3	RTU multiprotocol datalogger.
Z-PC-DINAL1-35	DIN rail support with screw terminals P= 35 mm.
Z-PC-DIN1-35	DIN rail with one slot support for rear connector P= 35 mm.
FD01	Photodetector for pulse counter, MAX frequency 10 Hz.

CONTACTS

Technical support	Support@seneca.it	Product Informations	Sales@seneca.it
-------------------	-------------------	----------------------	-----------------