



K109PT-HPC

TEMPERATURE-INSULATED CONVERTER FOR PT100 PROBES

General Description

The K109PT-HPC instrument converts a temperature signal read by a PT100 probe (EN 60 751) with connection by 2, 3 or 4 wires into a signal normalised in voltage or current. Resolution 14 bit.

The module's main features are its compact size (6.2 mm), attachment to a 35 mm DIN rail, bus-connector power supply option, quick connection by spring terminals, 3-point insulation, and easy configuration in the field by DIP-switch.

Technical Features

Power supply:	19,2..30 Vdc
Consumption:	Max 24 mA at 24 Vdc
Input:	PT100 probe, EN 60751/A2 (ITS90) connection by 2, 3 or 4 wires
Current on sensor:	< 900 uA
Cable resistance:	Max. 15 Ω per wire
Measurement Range:	-200..160 $^{\circ}$ C
Resistance Range:	18..162 Ω
Minimum span :	20 $^{\circ}$ C
Voltage output:	0..5 Vdc, 1..5 Vdc, 0..10 Vdc and 10..0 Vdc Minima load resistance: 2 k Ω
Current output:	0..20 mA, 4..20 mA, 20..0 mA e 20..4 mA Maximum load resistance: 500 Ω
Output in case of over-range:	102.5% of full scale value (see Table on Page 5)
Output in case of malfunction:	105% of full scale value (see Table on Page 5)
Current output protection:	approximately 25 mA
Transmission error:	0.1 % (max. range), or (20 K / Δ temp + 0.05) % (Measurement range)
Temperature Coefficient:	100 ppm
Response time (10..90 %):	< 50 ms (without filter) < 200 ms (with repeat filter 50 Hz)
Insulation Voltage:	1,5 kV (50 Hz for 1 min)
Protection Index:	IP20
Operating Conditions:	Temperature -20..+65 $^{\circ}$ C Humidity 30..90 % at 40 $^{\circ}$ C (non-condensing)
Storage Temperature:	-40..+85 $^{\circ}$ C
LED Signalling:	Setting error, connection malfunction, internal malfunction.
Connections:	Spring terminals
Conductor Section:	0,2..2,5 mm ²

Wire stripping:	8 mm
Box:	PBT (black colour)
Dimensions, Weight:	6,2 x 93,1 x 102,5 mm, 50 g.
Standards:	EN61000-6-4/2002 (electromagnetic emission, industrial surroundings) EN61000-6-2/2005 (electromagnetic immunity, industrial surroundings) EN61010-1/2001 (safety)
	All the circuits must be provided with double insulation from the circuits under dangerous voltage. The power supply transformer must be built to compliance with EN60742: "Insulation transformers and Safety transformers".

Installation rules

This module has been designed for assembly on a DIN 46277 rail. Assembly in vertical position is recommended in order to increase the module's ventilation, and no raceways or other objects that compromise aeration must be positioned in the vicinity. Do not position the module above equipment that generates heat; we recommend positioning the module in the lower part of the control panel or container compartment. We recommend rail-type assembly using the corresponding bus connector (Code K-BUS) that eliminates the need to connect the power supply to each module.

Inserting the module in the rail

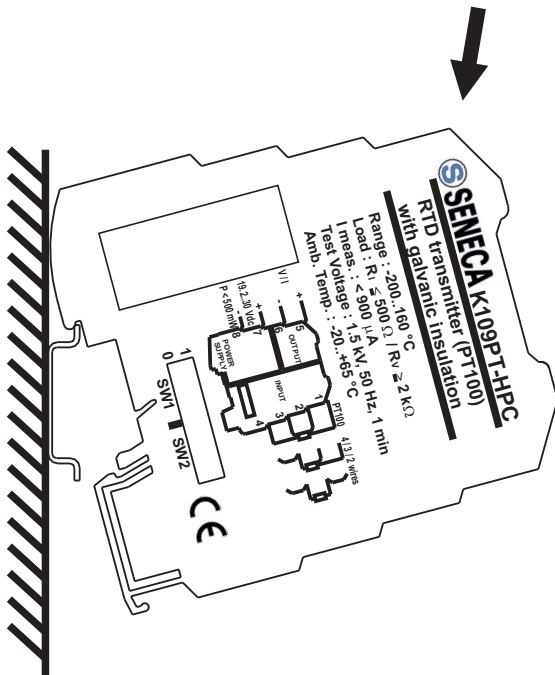

- 1 - Attach the module in the upper part of the rail.
- 2 - Press the module downwards.

Removing the module from the rail

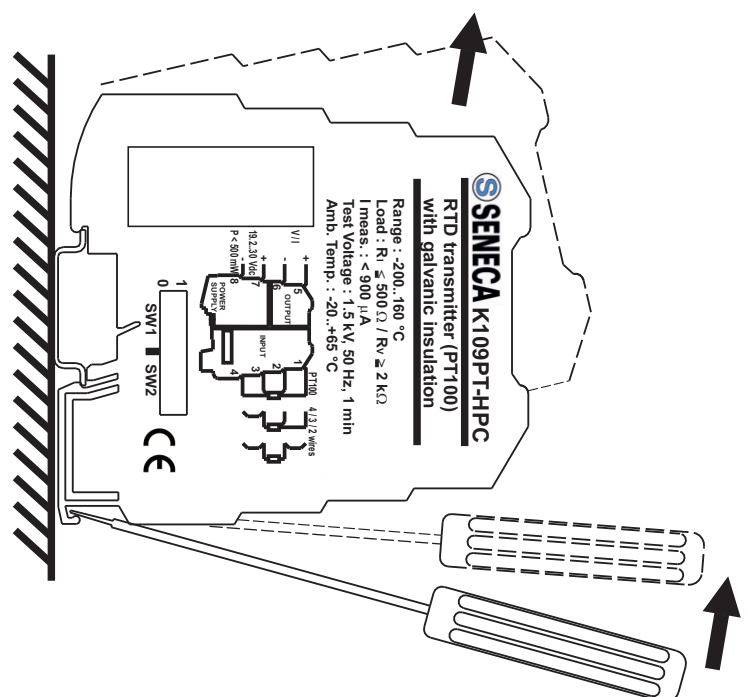

- 1 - Apply leverage using a screwdriver (as shown in the figure).
- 2 - Rotate the module upwards.

Using the K-BUS

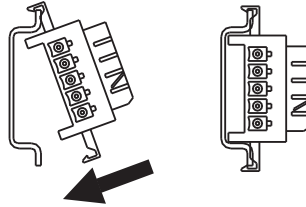
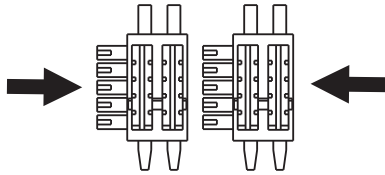

- 1 - Compose the K-BUS connectors as required in order to obtain the number of positions necessary (each K-BUS permits the insertion of no. 2 modules).
- 2 - Insert the K-BUS connectors in the rail by positioning them on the upper side of the rail and then rotating them downwards.

IMPORTANT: Pay particular attention to the position of the protrudent terminals of the K-BUS. The K-bus must be inserted in the guide with the protrudent terminals on the left (as shown in the figure) otherwise the modules are turned upside downs.



- Never connect the power supply directly to the bus connector on the DIN rail.
- Never tap power supply from the bus connector either directly or by using the module's terminals.

SETTING OF THE DIP-SWITCHES

Factory setting

All the module DIP switches are at pos. 0 as default configuration.
This set correspond to the following configuration :

PT100 wiring	→ 3 wires
Input Filter	→ present
Output Signal	→ 4..20 mA
Measurement Range Start	→ -20 °C
Measurement Full-Scale	→ 160 °C
Output signal in case of Malfunction	→ Towards the top of the output range
Over-Range	→ YES: a 2.5% over-range value is acceptable; a 5% over-range value is considered a malfunction.

It is understood that this configuration is valid only with all the DIP switches at position 0.

If also one Dip is moved, it is necessary to set all the other parameter as indicated on the following tables.

Note: for all following tables

The indication ● indicates that the DIP-switch is set in Position 1 (ON).

No indication is provided when the DIP-switch is set in Position 0 (OFF).

PT100 WIRING	
SW1	1
	● 2 / 4 wires
	3 wires

INPUT FILTER (*)	
SW1	2
	● Absent
	Present

(*) The input filter slows down the response time to around 200 ms and guarantees the repeating of the disturbance signal at 50 Hz overlapping the measurement signal.

OUTPUT SIGNAL				
SW1	3	4	5	
				4..20 mA
	●			0..20 mA
		●		20..4 mA
	●	●		20..0 mA
			●	0..10 Vdc
		●	●	10..0 Vdc
	●	●	●	0..5 Vdc
	●		●	1..5 Vdc

MEASUREMENT RANGE START					
	SW1			SW2	
	6	7	8	1	°C
					0
	●				10
		●			20
	●	●			30
			●		40
	●		●		50
		●	●		80
	●	●	●		100
				●	-10
	●			●	-20
		●		●	-30
	●	●		●	-40
			●	●	-50
	●		●	●	-100
		●	●	●	-150
	●	●	●	●	-200

MEASUREMENT FULL SCALE						
SW2						°C
2	3	4	5	6		
						0
					●	80
●					●	85
	●				●	90
●	●				●	95
		●			●	100
●		●			●	105
	●	●			●	110
●	●	●			●	115
			●		●	120
●			●		●	125
	●		●		●	130
●	●		●		●	135
		●	●		●	140
●		●	●		●	145
	●	●	●		●	150
●	●	●	●		●	160

OUTPUT SIGNAL IN CASE OF MALFUNCTION	
SW2	7
	● Towards the bottom of the output range
	Towards the top of the output range

OVER-RANGE (*)	
SW2	8
	● NO: the malfunction alone causes a 2.5% over-range value.
	YES: a 2.5% over-range value is acceptable; a 5% over-range value is considered a malfunction.

(*) See the table below for the corresponding values.

Output signal limit	Over-range / Malfunction $\pm 2,5\%$	Malfunction $\pm 5\%$
20 mA	20,5 mA	21 mA
4 mA	3,5 mA	3 mA
0 mA	0 mA	0 mA
10 Vdc	10,25 Vdc	10,5 Vdc
5 Vdc	5,125 Vdc	5,25 Vdc
1 Vdc	0,875 Vdc	0,25 Vdc
0 Vdc	0 Vdc	0 Vdc

Electrical Connections

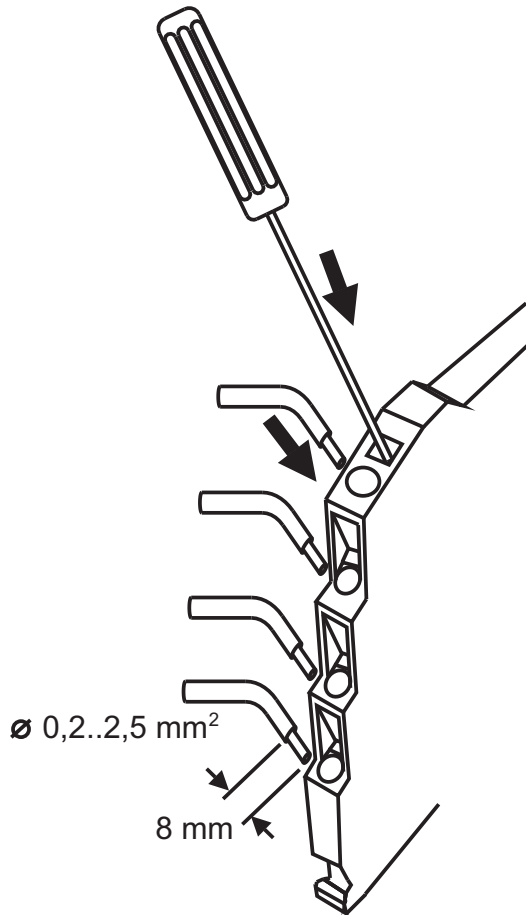

The module has been designed for spring-type terminal electrical connections.

Proceed as follows to make the connections:

- 1 - Strip the cables by 0.8 mm
- 2 - Insert a screwdriver in the square hole and press it until the cable lock spring opens.
- 3 - Insert the cable in the round hole.
- 4 - Remove the screwdriver and make sure that the cable is tightly fastened in the terminal.

Power supply

There are various ways to provide the K Series modules with power.

1 - Direct power supply to the modules by connecting 24 Vdc power supply directly to Terminals 7 (+) and 8 (-) of each module.

2 - Using the K-BUS connector accessory for the distribution of the power supply to the modules via bus connector, in this way eliminating the need to connect power supply to each module.

The bus can be supplied from any of the modules; the total absorption of the bus must be less than 400 mA. Higher absorption values can damage the module. An appropriately sized fuse must be connected in series to the power supply.

3 - Using the K-BUS connector accessory for the distribution of the power supply to the modules via bus connector and the K-SUPPLY accessory for the connection of the power supply.

The K-SUPPLY accessory is a 6.2 mm wide module that contains a set of protections designed to protect the modules connected via bus against over-voltage loads.

The bus connector can be provided with power using the K-SUPPLY module if the total absorption of the bus is less than 1.5 A. Higher absorption values can damage both the module and the bus. An appropriately sized fuse must be connected in series to the power supply.

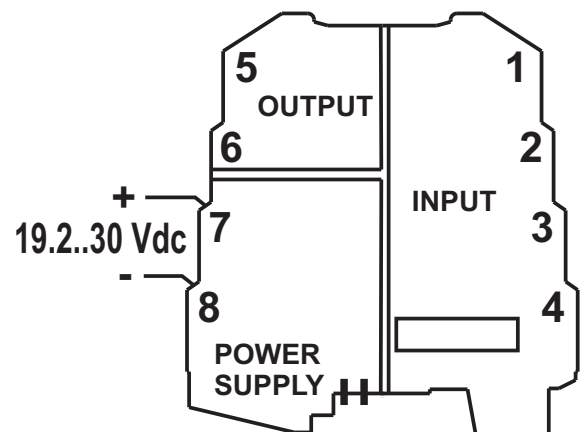

Input

The module accepts input from a PT100 temperature probe (EN 60 751) with connection by 2, 3 or 4 wires.

The use of shield cables is recommended for the electronic connections.

2-wire connection

This is the connection to be used for short distances (< 10 m) between module and probe, bearing in mind that it adds an error equivalent to the resistance contributed by the connection cables to the measurement.

DIP-switch SW1-1 set in Position 1 (ON) (2 / 4 wires).

With bridges between Terminals 1 and 2 and Terminals 3 and 4.

3-wire connection

This is the connection to be used for media-long distances (> 10 m) between module and probe. The instrument performs compensation for the resistance of the connection cables. In order for compensation to be correct, it is necessary that the resistance values of all cables be equal because in order to perform compensation the instrument measures the resistance of only one cable and assumes the resistance of the others cables to be exactly the same.

DIP-switch SW1-1 set in Position 0 (OFF) (3 wires).

With bridge between Terminals 3 and 4.

4-wire connection

This connection to be used for media-long distances (> 10 m) between module and probe. Provides the maximum precision because the instrument measure the resistance of the sensor independently of the resistance of the connection cables.

DIP-switch SW1-1 set in Position 1 (ON) (2 / 4 wires).

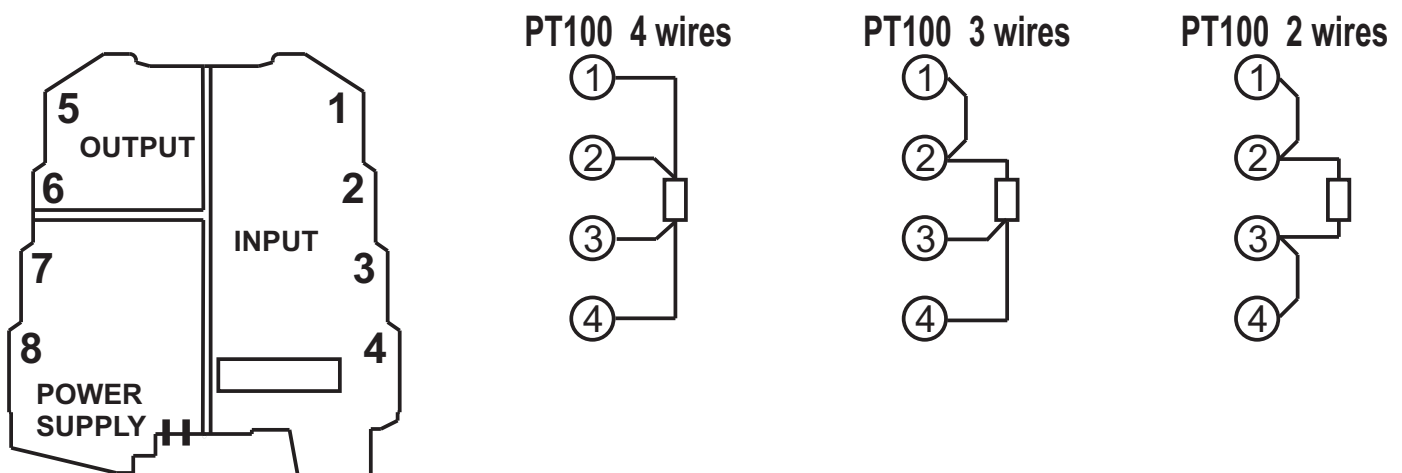

The PT100 measure is effected in impulsive way for a very short time to reduce the module consumption. For this reason, some electronic calibrators could not be able to generate the simulated signal in the right way.

Output

Voltage connection - Current connection (applied current)

The use of shield cables is recommended for the electronic connections.

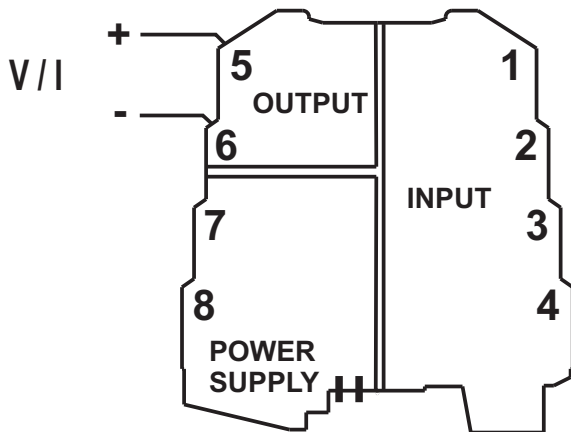

Note: in order to reduce the instrument's dissipation, we recommend either using the output for voltage or guaranteeing a load of $> 250 \Omega$ to the current output.

LED indications on the front

LED	Meaning
Rapid flashing 1 pulse/sec.	Internal malfunction
Slow flashing 3 pulses/sec.	DIP-switch setting error (SPAN $< 20^\circ \text{C}$)
Steady light	PT100 connection wire malfunction. 3 rd wire resistance over-range.



Disposal of Electrical & Electronic Equipment (Applicable throughout the European Union and other European countries with separate collection programs)

This symbol, found on your product or on its packaging, indicates that this product should not be treated as household waste when you wish to dispose of it. Instead, it should be handed over to an applicable collection point for the recycling of electrical and electronic equipment. By ensuring this product is disposed of correctly, you will help prevent potential negative consequences to the environment and human health, which could otherwise be caused by inappropriate disposal of this product. The recycling of materials will help to conserve natural resources. For more detailed information about the recycling of this product, please contact your local city office, waste disposal service or the retail store where you purchased this product.

This document is property of SENECA srl. Duplication and reproduction are forbidden, if not authorized. Contents of the present documentation refers to products and technologies described in it. All technical data contained in the document may be modified without prior notice Content of this documentation is subject to periodical revision.



SENECA s.r.l.

Via Austria, 26 - 35127 - PADOVA - ITALY

Tel. +39.049.8705355 - 8705359 - Fax +39.049.8706287

e-mail: info@seneca.it - www.seneca.it