

# PRODUCT OVERVIEW

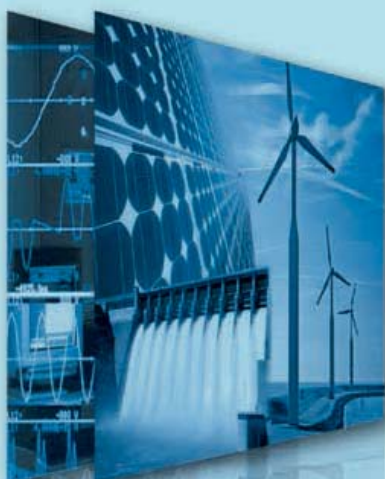

# SENECA

## COMPANY



With over **25 years** manufacturing in the industrial automation field, **SENECA** has grown to be a major force in the signal interfacing.

Our products lines, **designed** and developed in **Italy**, are compatible and open towards the more widespread technological standard.

Our **innovative product** lines, professional approach and worldwide network of trained distributors guarantee the most elegant solutions to all your process interfacing and data acquisition challenges.

## PRODUCTS

### SENECA takes care of your signals

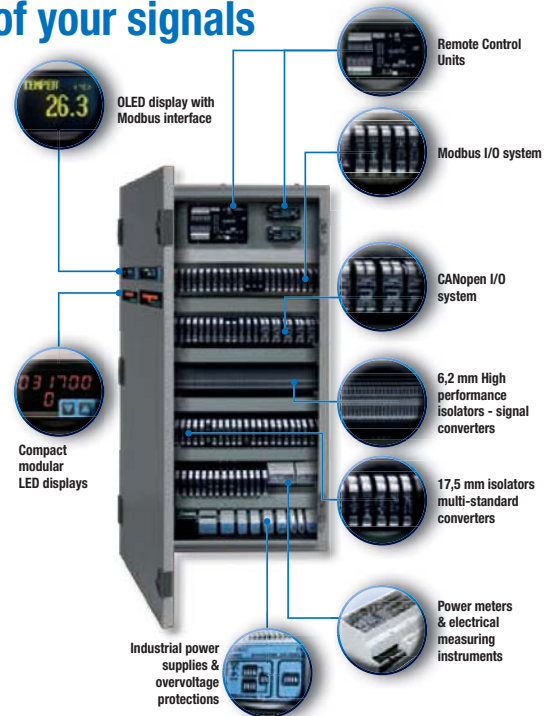

## QUALITY



**SENECA** produces own products according to the total **quality** criterias.

Our company system is **ISO 9001** certified since 1997.

The products are **UL UR CSA** approved for North American market and satisfies **RINA** requirements for naval applications.

The safety standard, electromagnetic compatibility and electric protection complies with **CE, IEC, EN norms**. The communication software interfaces are developed according the international recognized standard (i.e IEC 61131, ModBUS RTU / TCP, IEC 870, CanOPEN, PPP, SMTP, HTML, OPC Server).

## TECHNOLOGIES



The **production** cycles and internal control have processed through the best modern **SMT** (Surface Mounting Technology) & **PTH** (Pin Through Hole) lines. The production capacity is thousands components/hours and this allows to combine high speed, flexibility, reduced **MTBF** and time-to-market.

The productive process is fully complies to the environmental and eco-compatible directives: **RAEE, ROHS** and **REACH**.

At the end of the cycle all products are strictly tested through automatic systems generating finally single testing reports.

# INDEX

Pg 4



**MYALARM2**

Pg 5



**GSM/GPRS  
DEVICES**

Pg 6



**MODBUS I/O  
SYSTEM**

Pg 7



**CANOPEN I/O  
SYSTEM**

Pg 8



**TCP-IP I/O  
SYSTEM**

Pg 9



**COMMUNICATION  
INTERFACES**

Pg 10



**COMPUTING AND  
CONTROLLING  
UNITS**

Pg 11



**PLC AND  
MULTIFUNCTION  
CONTROLLERS**

Pg 12



**COMMUNICATION  
INTERFACES**

Pg 13



**RADIO  
DEVICES**

Pg 14



**SIGNAL  
CONVERTERS**

Pg 15



**DIGITAL  
INDICATORS**

Pg 16



**CURRENT  
TRANSFORMERS**

Pg 17



**POWER & ENERGY  
MANAGEMENT**

Pg 18



**TEMPERATURE  
CONVERTERS**

Pg 19



**SIGNAL SIMULATOR  
& MULTIMETER  
HANDHELD**



# MYALARM2

GSM/GPRS terminal, datalogger, alarms and telecontrol unit



## ORDER CODES

ORDER CODE	OPTION	DESCRIPTION
<b>MY2B</b>		GSM/GPRS Datalogger with Alarm Management
<b>MY2G</b>		GSM/GPRS Datalogger with GPS Position Control
<b>MY2S</b>		GSM/GPRS Datalogger with Vocal Alarms and DTMF Tones
<b>SPST Relay Board</b>	-0	No
	-R	Yes
	-0	Standard Communication
	-M	Clamps connection
<b>Colors</b>	-B	Blue
	-G	Grey



## APPLICATION CASES

### AUTOMATIC GATES CONTROL



### WATER PLANT MONITORING



### BOILER & HVAC REMOTE CONTROL



### PLANTS TELECONTROL

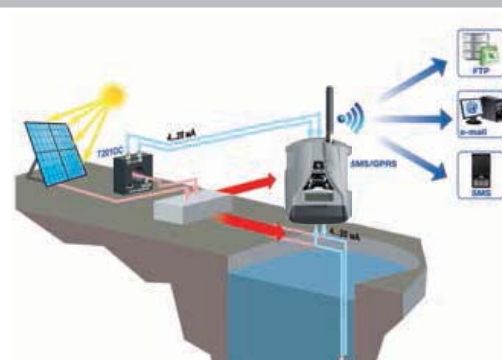

# GSM/ GPRS/3G DEVICES



## Z-GPRS2 - GSM/GPRS datalogger with built-in IOs e telecontrol functions



ORDER CODES	
ORDER CODE	DESCRIPTION
Z-miniRTU	GSM/GPRS telecontrol device, with built-in I/Os, Straton
Z-GPRS2	GSM/GPRS datalogger with built-in IOs e telecontrol functions
Z-MODEM	Industrial GSM - GPRS Quadband Modem
Z-MODEM-3G	Industrial GSM - GPRS/3G Quadband Modem
M-RTU-GP	GSM/GPRS battery powered compact telemetry unit
M-RTU-PC	GSM/GPRS compact telemetry unit for cathodic protection

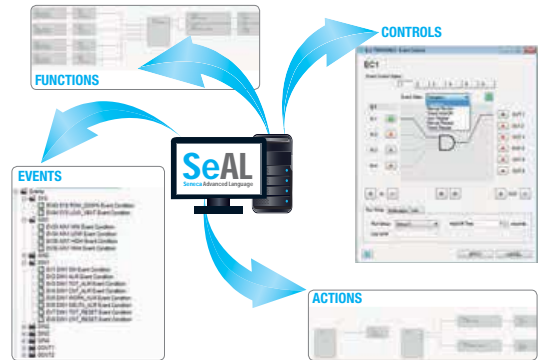

## APPLICATION CASES

GSM/GPRS REMOTE CONTROLLER	POWER CONSUMPTION MONITORING
REMOTE DATA ACQUISITION	CONTROL OF PHOTOVOLTAIC INVERTERS

# MODBUS I/O SYSTEMS



## S401

ModBUS RTU indicator with OLED 2,7" display



## Z-SG

1-CH Load Cell Input ModBUS RTU module



## Z-8AI

8-CH Analog Input ModBUS RTU module



TOP PRODUCTS

## Z-4DI-2AI-2DO

4 -CH Digital Input/ 2 -CH Analogue Input, 2 -CH Digital Output, Modbus RTU module



## ORDER CODES

ORDER CODE	DESCRIPTION
Z-SG	Strain gauge module / Analogue out + ModBUS RTU
Z-4DI-2AI-2DO	Module with 2 AI, 2 DO, 4 DI, ModBUS RTU/ModBUS TCP-IP
Z-D-IN	5 CH DI module / RS485 ModBUS RTU
Z-D-OUT	5 CH DO Relay module / RS485 ModBUS RTU
Z-10-D-IN	10 CH DI module / RS485 ModBUS RTU
ZC-24DI	24 CH DI module / CANopen-RS485 ModBUS RTU
ZC-24DO	24 CH DO module / CANopen-RS485 ModBUS RTU
ZC-16DI-8DO	16 CH DI / 8 CH DO module / CANopen-RS485 ModBUS RTU
Z-10-D-OUT	10 CH DO module / RS485 ModBUS RTU
Z-D-IO	5 CH DI / 2 CH DO module / RS485 ModBUS RTU
Z-DAQ-PID	1 CH AI Universal / RS485 ModBUS RTU with PID regulation
Z-4AI	4 CH AI module / RS485 ModBUS RTU
Z-8AI	8 CH AI module / RS485 ModBUS RTU
Z-3AO	3 CH AO module / RS485 ModBUS RTU
Z-4RTD-2	4 CH RTD input module / RS485 ModBUS RTU
Z-4TC	4 CH TC input module / RS485 ModBUS RTU
Z-8TC	8 CH TC input module / RS485 ModBUS RTU
Z203-1	Single Phase power 500 AC- 5A / Analogue out + ModBUS RTU
Z204-1	AC/DC voltage to DC current/ voltage isolator/converter + ModBUS RTU
DR-2	Acquisition&recording softw. for Z-PC system 2 channels
DR-4	Acquisition&recording softw. for Z-PC system 4 channels
DR-8	Acquisition&recording softw. for Z-PC system 8 channels
DR-16	Acquisition&recording softw. for Z-PC system 16 channels
DR-32	Acquisition&recording softw. for Z-PC system 32 channels
DR-64	Acquisition&recording softw. for Z-PC system 64 channels
S401-L	Modbus RTU indicator with OLED 2,7" display

## APPLICATION CASES

### TANK MONITORING SYSTEM

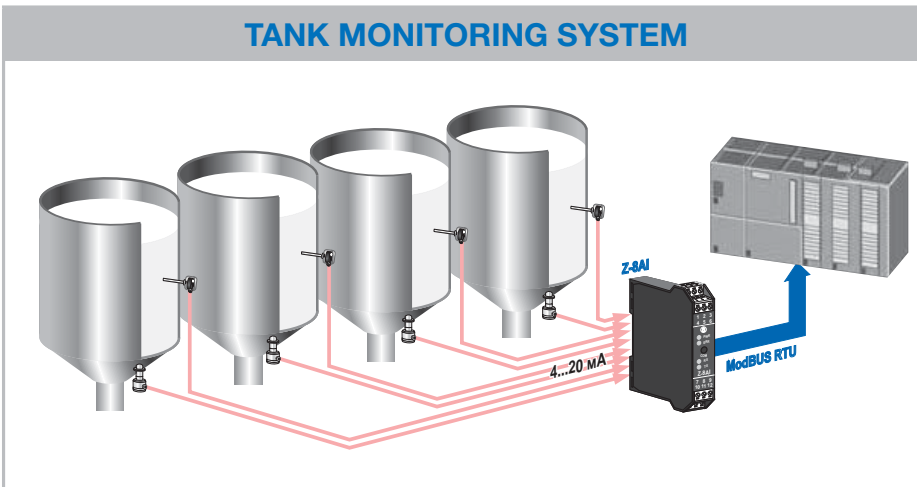



# CANOPEN I/O SYSTEMS



## ZC-24DI

24-CH digital input  
CANopen / ModBUS



## ZC-24DO

24-CH digital output  
CANopen / ModBUS



## ORDER CODES

ORDER CODE	DESCRIPTION
ZC-24DI	24 CH digital input CANopen / ModBUS module
ZC-24DO	24 CH digital output CANopen / ModBUS module
ZC-16DI-8DO	16 CH digital input / 8 CH digital output CANopen / ModBUS module
ZC-8AI	8 CH analog input CANopen module
ZC-3AO	3 CH analog output CANopen module
ZC-4RTD	4 CH RTD (P100, Ni100, Pt500, Pt1000) input CANopen module
ZC-8TC	8 CH Thermocouple (J,K,E,N,S,R,B,T) CANopen module
ZC-SG	1 CH strain gauge CANopen module

TOP PRODUCTS

## ZC-8AI

8-CH analog input (mA, V)  
CANopen module



## ZC-3AO

3-CH analog output (mA, V)  
CANopen module



## APPLICATION CASES

### HANDLING SYSTEM

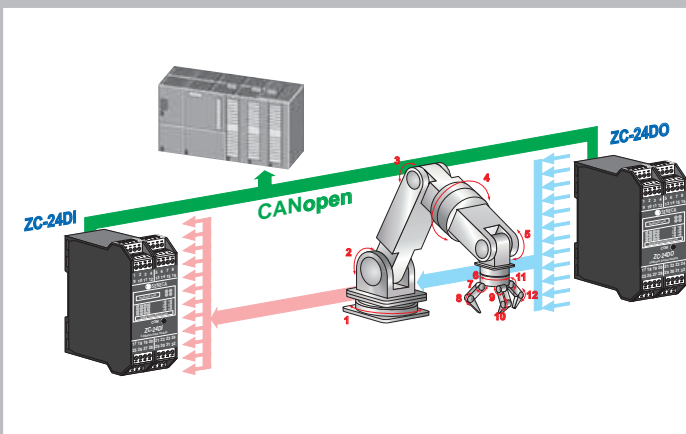

### AUTOMATIC BOTTLING SYSTEM

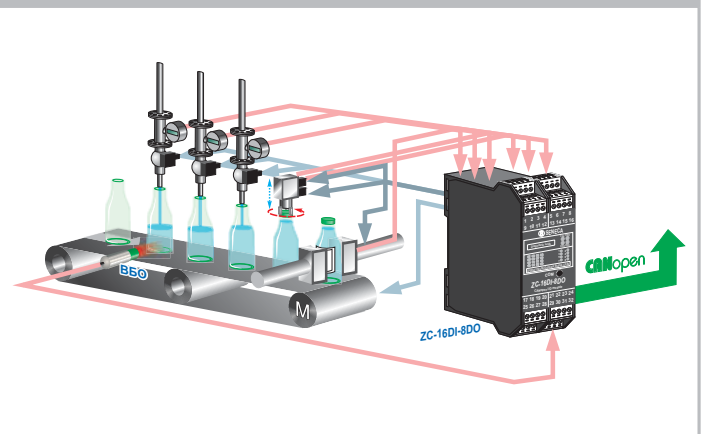

# TCP-IP I/O SYSTEMS

## ZE-2AI

2-CH Analogue input Modbus RTU  
- Modbus TCP-IP module



## ZE-4DI-2AI-2DO

4 CH Digital Input/ 2 CH  
Analogue Input, 2 CH Digital  
Output, Modbus RTU



## ORDER CODES

ORDER CODE	DESCRIPTION
ZE-2AI	Module with 2 analog inputs, ModBUS RTU / ModBUS TCP-IP
ZE-4DI-2AI-2DO	Module with 2 AI, 2 DO, 4 DI, ModBUS RTU / ModBUS TCP-IP
Z-KEY	Ethernet serial gateway
Z-LOGGER	Datalogger, alarm module with built-in I/Os

TOP PRODUCTS

## Z-KEY

Ethernet  
serial gateway



- Bridge
- ModBUS gateway
- Remote virtual-com

### COMPATIBILITY



### WEB SERVER CONFIGURATION



## APPLICATION CASES

### MODBUS TCP-IP RETRANSMISSION

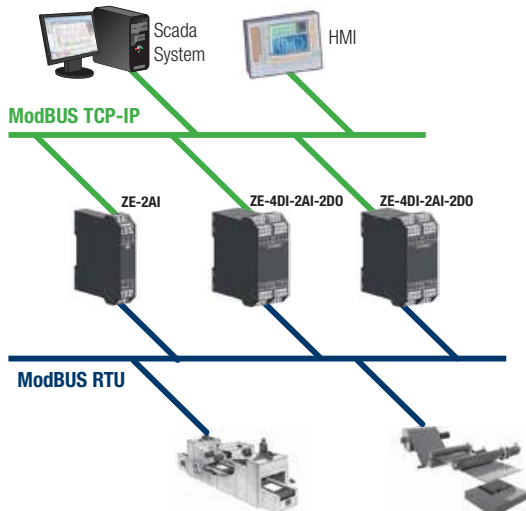

### ALARM MANAGEMENT & DATALOGGING

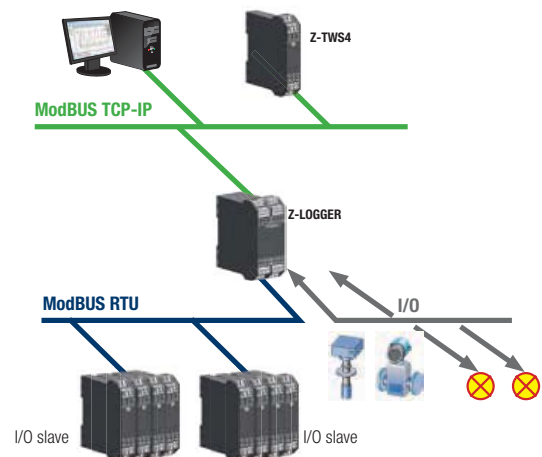



# ETHERNET COMMUNICATION INTERFACES

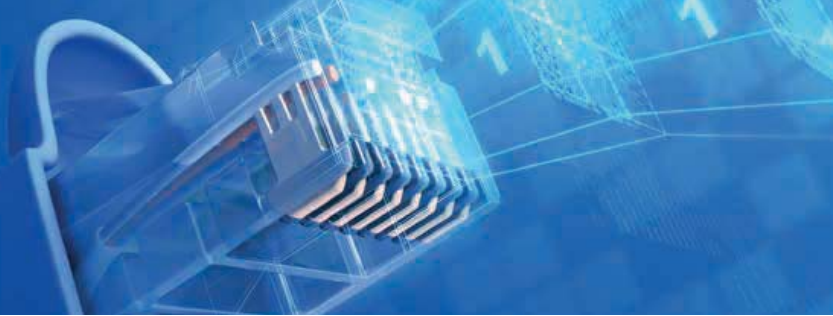

## Z-PASS1

Ethernet to serial gateway



## Z-PASS2

Ethernet/3G to serial gateway



## ORDER CODES

ORDER CODE	DESCRIPTION
Z-PASS1	Ethernet to serial gateway
Z-PASS2	Ethernet/3G to serial gateway
Z-miniRTU	GSM/GPRS telecontrol device, with built-in I/Os, Straton
Z-KEY	Ethernet serial gateway



## Z-miniRTU

GSM/GPRS telecontrol device, with built-in I/Os, Straton



## Z-KEY

Ethernet serial gateway



## APPLICATION CASES

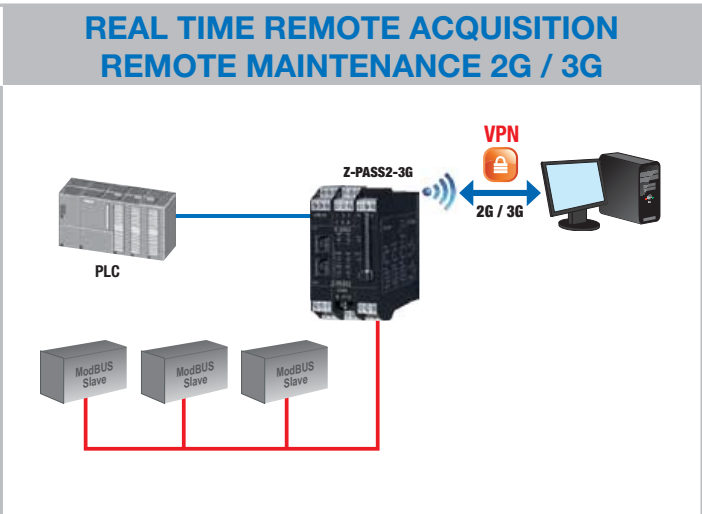
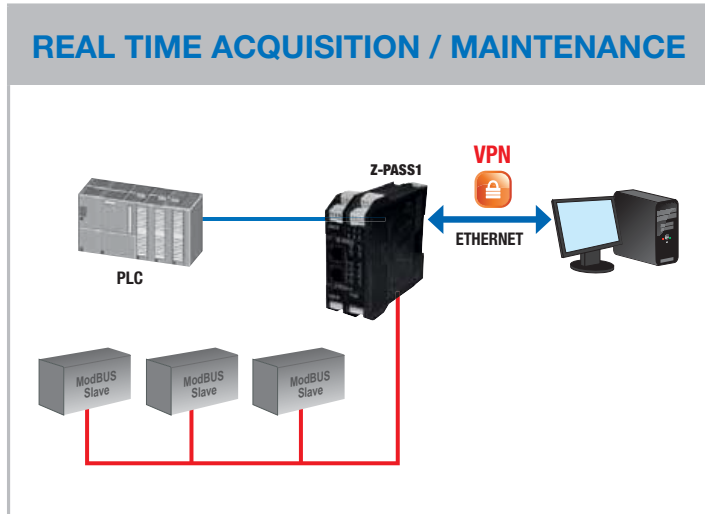

# COMPUTING AND CONTROLLING UNITS

## Z-FLOWCOMPUTER

### VISUAL1

Display plc



## Z-4000

Computing Unit



### ORDER CODES

ORDER CODE	DESCRIPTION
Z-FLOWCOMPUTER	Calculation unit for flow-rate and energy measurement with HMI
Z-4000	Computing Unit
S6001	Advanced pumps controller

TOP PRODUCTS

## S6001

Advanced pumps controller



- 3G remote connection
- All-in-one remote terminal unit
- Pump automation controller

## APPLICATION CASES

### THERMICAL ENERGY MANAGEMENT WITH HMI

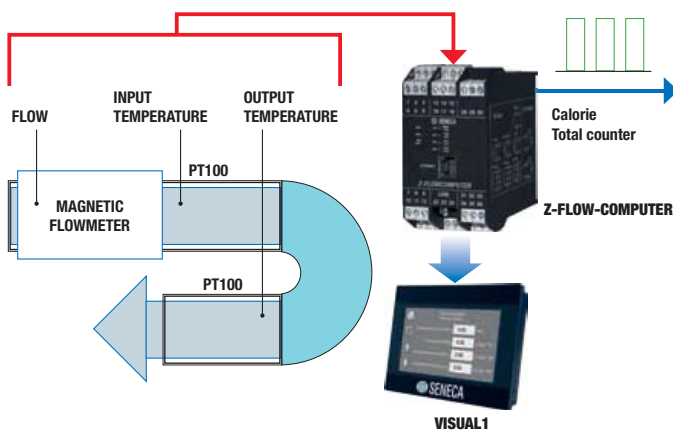

### OXYGENATION AND OXIDATION TANK (SEWAGE TREATMENT WATER PLANT, FISH FARMS, ETC.)

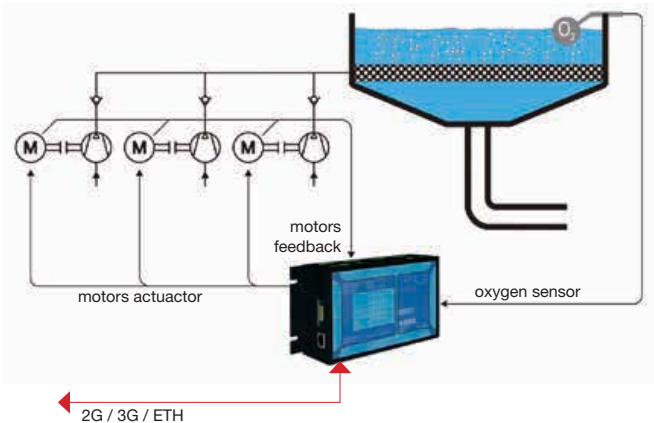

# PLC AND MULTIFUNCTION CONTROLLERS



## Z-TWS5

Multi-function controller  
CoDeSys Embedded



## Z-TWS11

Multi-function controller  
Straton Embedded



## ORDER CODES

ORDER CODE	DESCRIPTION
Z-TWS5	Multi-function controller CoDeSys Embedded
Z-TWS11	Multi-function controller Straton Embedded
Z-TWS4-L-0	Advanced multi-function web controller (PLC, Web Server, Gateway) – Linux based
Z-TWS4-L-K	Advanced multi-function web controller (PLC, Web Server, Gateway) – Linux based + Cable + Configuration SW
Z-TWS4-S-0	Advanced multi-function web controller (PLC, Web Server, Gateway) – Straton Embedded
Z-TWS4-S-K	Advanced multi-function web controller (PLC, Web Server, Gateway) – Straton Embedded + Cable + Configuration SW

**TOP PRODUCTS**

## Z-TWS4

Advanced multi-function web controller



- IEC 61850, IEC 61870 energy protocols
- Straton Embedded PLC
- VPN remote control

## APPLICATION CASES

### POWER PLANT MANAGEMENT WITH IEC 61850, IEC 61870 PROTOCOL INTERFACE

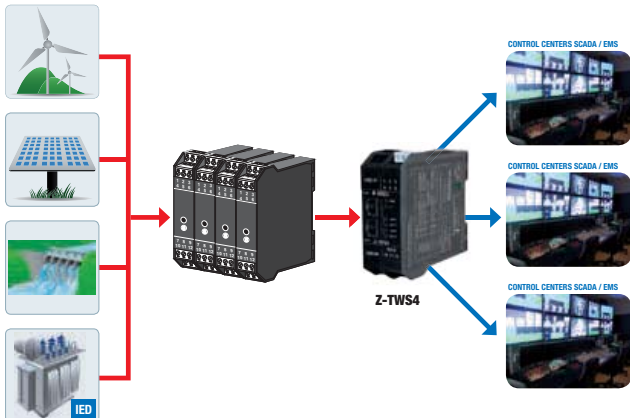

### MULTIFUNCTION CONTROLLER CODESYS EMBEDDED

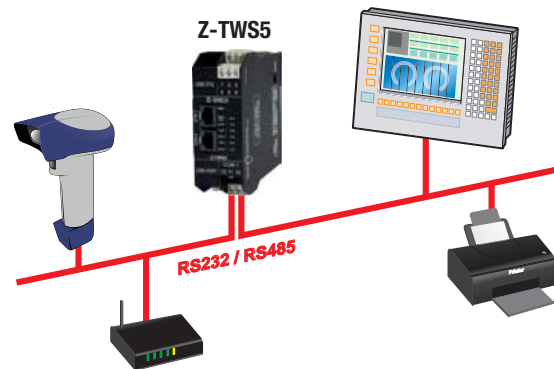



# COMMUNICATION INTERFACES



## K107A

RS485 ↔ RS485 Serial Isolator / Amplifier



**SERIAL**

## S107USB

USB ↔ RS485 serial converter (desk version), drivers and cable included



**USB**

## S117P-1

RS232/TTL/RS485 to USB serial converter



**TOP PRODUCTS**

## Z107FO

Fiber Optic serial (RS232/RS485) converter



**OPTIC**

## ORDER CODES

ORDER CODE	DESCRIPTION
K107A	RS485 ↔ RS485 serial amplifier/Isolator
K107B	RS232 ↔ RS485 serial converter/Isolator
Z107	RS232 ↔ RS485/422 converter / Isolator
S107P	RS232 ↔ RS485/422 converter / Isolator (desk version)
S107USB	USB ↔ RS485 converter / Isolator (desk version)
K107USB	USB ↔ RS485 converter / Isolator
S117P-1	USB ↔ RS232/TTL/RS485/ converter/Isolator+cable PM001601
Z107FO	RS232-RS485 ↔ Fiber Optic interface
ZC-107FO	CANBUS ↔ Fiber Optic interface
S232-SL	Converter RS232 To Fiber Optic - Single Loop
S232-DL	Converter RS232 To Fiber Optic - Double Loop
S485-SL	Converter RS485 To Fiber Optic - Single Loop
S485-DL	Converter RS485 To Fiber Optic - Double Loop

## APPLICATION CASES

### RS485 SERIAL CONNECTION

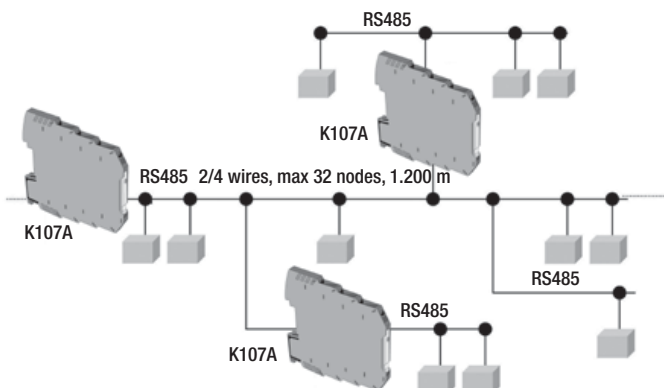

### MODBUS RTU TO TCP-IP CONVERSION

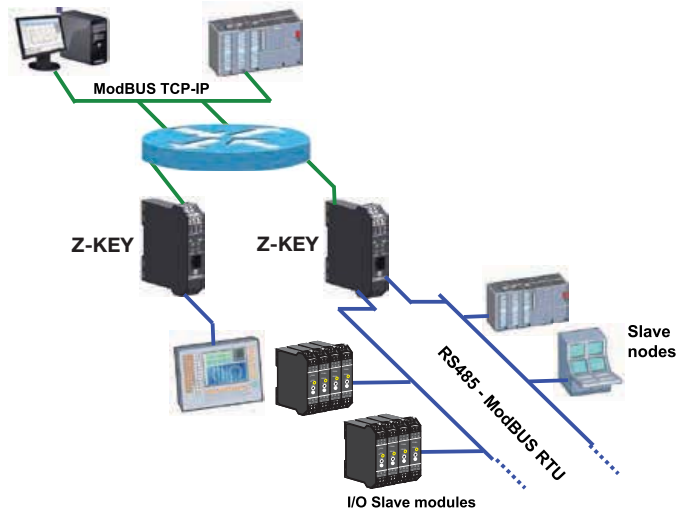

# RADIO DEVICES



## Z-LINK1

**869 Mhz Radiomodem with RS232/RS485 interface and Mesh Network Capability**

Frequency: 869 Mhz  
Distance: ~ 400 m  
Power: <20 mW



**TOP PRODUCTS**



## Z-AIR

**868-870 Mhz UHF Radiomodem**

Frequency: 869 Mhz  
Distance: ~ 7 km  
Power: 25..500 mW

## ORDER CODES

ORDER CODE	DESCRIPTION
Z-LINK1	869 MHz Radiomodem + RS232/RS485 interface and Mesh Network support
Z-AIR	868-870 MHz UHF Radiomodem

## APPLICATION CASES

### SERIAL NETWORK EXTENSION

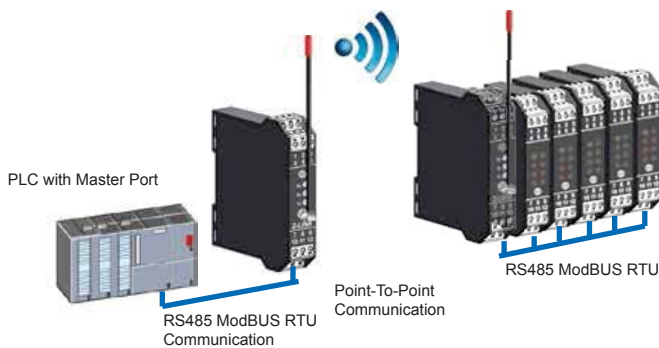

### MESH NETWORK SUPPORT

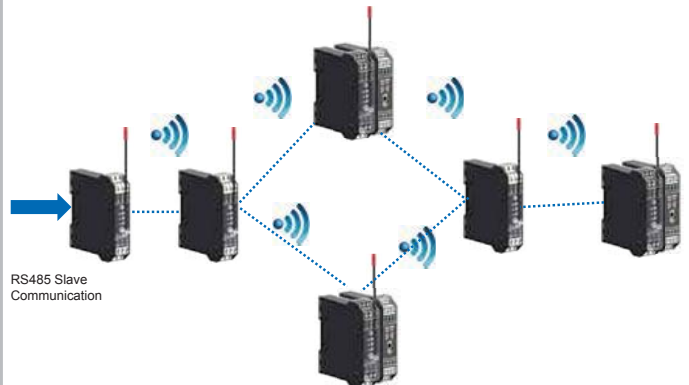

### POINT-TO-POINT TRANSMISSION (I/O REPETITION)

Frequency 868 – 870 MHz | Speed 4,8 – 9,6 Kbps | Power 25 – 500 mW

**A STATION**



**B STATION**



Analog-Digital Input/Output of B STATION

Analog-Digital Input/Output of A STATION

### POINT-TO-MULTIPOINT TRANSMISSION (I/O REPETITION)

Frequency 868 – 870 MHz | Speed 4,8 – 9,6 Kbps | Power 25 – 500 mW

**A STATION**



**B STATION**



**C STATION**



# SIGNAL CONVERTERS



## K109PT

Pt100 to DC Current / Voltage Isolator / Converter



## K109S

DC Current / Voltage to DC Current / Voltage Isolator / Converter



TOP PRODUCTS

## Z170REG

DC Current/Voltage duplicator/ isolator with universal input and 2 output



## Z201

AC Current (5-10 A) to DC Current/Voltage Isolator/Converter



## ORDER CODES

ORDER CODE	DESCRIPTION
Z109REG2	Universal Isolator/Converter with special functions 9..40 Vdc-19..28 Vac
Z109REG-BP	Universal converter with bipolar mA / V output
Z109UI2	DC Current/Voltage to DC Current/Voltage Isolator/Converter
Z110S/D	Current isolator for 4..20mA loops -1/2 channel (Self powered)
Z102	Potentiometer to DC Current/Voltage Isolator/Converter
Z201	AC Current (5-10 A) to DC Current/Voltage Isolator/Converter
Z202	AC Voltage (500 A) to DC Current/Voltage Isolator/Converter
Z202-LP	500 VAC- 540 VDC to 4..20 mA Converter (loop powered)
Z203-1	Single Phase Power 500 VAC- 5A to DC I/V Isolator /Converter
Z-SG	Strain gauge module / Analogue out + ModBUS RTU
Z109PT2	RTD to DC Current/Voltage Isolator/Converter
Z109TC2	TC to DC Current/Voltage Isolator/Converter
Z104	DC Current/Voltage to frequency isolator/converter
Z111	Frequency to DC Current/Voltage Isolator/Converter
Z170REG	DC Current/Voltage duplicator/isolator with universal input and 2 output
Z190	DC Current/Voltage Adder/subtractor
Z112A	Digital contact amplifier 1 channel
Z112D	Digital contact amplifier 2 channels
Z113-1	Trip alarm module with universal analog input
Z113S/D/T	Trip alarm module for mA/V signals - 1/2/3 relay
K109PT	PT100 to DC Current/Voltage Isolator/Converter
K109PT1000	PT1000 to DC Current/Voltage Converter
K120RTD	Pt100 / Ni100 to 4..20 mA (loop powered)-non isolated
K109TC	TC to DC Current/Voltage Isolator/Converter-with alarm
K121	Converter with Univ. input, loop powered
K109UI	DC Current/Voltage to DC Current/Voltage Isolator/Converter
K109S	DC Current/Voltage to DC Current/Voltage Converter
K109LV	mV to DC Current/Voltage Converter
K111	Frequency Trip alarm unit
K112	Universal digital Coupler/Isolator

## APPLICATION CASES

### ANALOG SIGNAL DUPLICATION AND RETRANSMISSION

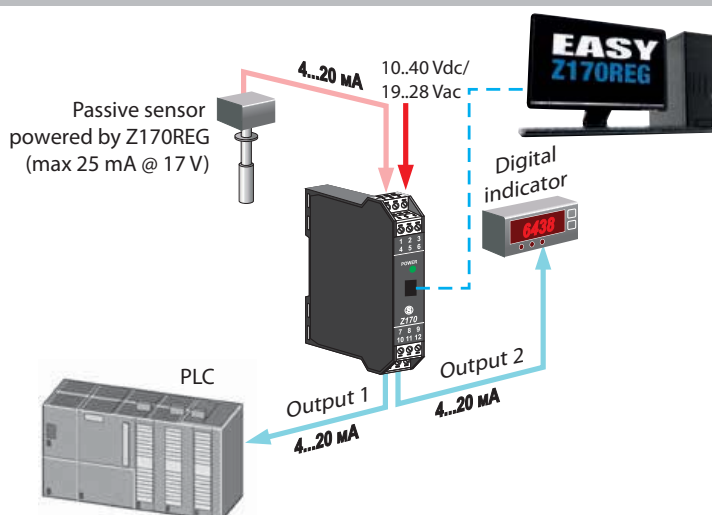



# DIGITAL INDICATORS



**NEW FEATURE!**  
Alarm on total Value

## S311D

Frequency meter/totalizer with universal digital input



## S311AK

High-precision Indicator with analog input, 4 digits



**TOP PRODUCTS**

## S312A

Analog Indicator 4-Digits Display with 4 relay outputs



## S315

Loop powered Indicator 4 digits, 4-20 mA input



## ORDER CODES

ORDER CODE	DESCRIPTION
S401-L	Oled display with Modbus interface, 10-40 Vdc, 19-28 Vac
S311A-4-H	Indicator-Totalizer with universal analogue input, 80-265 Vac, 4 digits
S311A-6-H	Indicator-Totalizer with universal analogue input 80-265 Vac, 6 digits
S311A-8-H	Indicator-Totalizer with universal analogue input 80-265 Vac, 8 digits
S311A-11-H	Indicator-Totalizer with universal analogue input 80-265 Vac, 11 digits
S311A-4-L	Indicator-Totalizer with universal analogue input, 10-40 Vdc / 19-28 Vac, 4 digits
S311A-6-L	Indicator-Totalizer with universal analogue input, 10-40 Vdc / 19-28 Vac, 6 digits
S311A-8-L	Indicator-Totalizer with universal analogue input, 10-40 Vdc / 19-28 Vac, 8 digits
S311A-11-L	Indicator-Totalizer with universal analogue input, 10-40 Vdc / 19-28 Vac, 11 digits
S311D-6-H	Frequency / digital Indicator - Totalizer, 80 -265 Vac, 6 digits
S311D-8-H	Frequency / digital Indicator - Totalizer, 80 -265 Vac, 8 digits
S311D-6-L	Frequency / digital Indicator - Totalizer, 10 -40 Vdc/ 19-28 Vac, 6 digits
S311D-8-L	Frequency / digital Indicator - Totalizer, 10 -40 Vdc/ 19-28 Vac, 8 digits
S311AK-4-L	High-precision Indicator with analog input, 4 digits
S311AK-4-L-IP66	High-precision Indicator with analog input, 4 digits, with IP66 protection
S312A	Analog Indicator 4-Digits Display with 4 relay outputs
S315	Loop powered Indicator 4 digits,4-20 mA input
S315-IP66	Loop powered Indicator 4 digits,4-20 mA input, with IP66 protection
S21-1-ST	Batch controller with clock, 115-230 Vac
S21-23-ST	Batch controller with clock, 24 Vac/dc
S21EX-1-ST	Batch controller with clock, in EEXd explosion proof case 115-230 Vac

## APPLICATION CASES

### ANALOG SIGNAL VISUALIZATION WITH ALARM TRIP

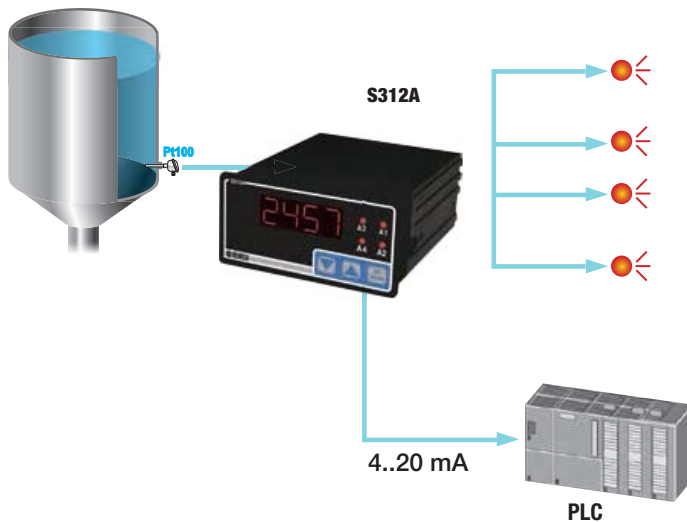

# CURRENT TRANSFORMERS



## T201

AC Current Transducer  
(output 4..20 mA – loop powered)



## T201DC

DC Current Transducer  
(output 4..20 mA – loop powered)



## ORDER CODES

ORDER CODE	DESCRIPTION
T201	AC Current Transducer 5-40 A to 4..20 mA (Loop powered)
T201DC	DC Current Transducer 5-40 A to 4..20 mA (Loop powered )
T201DC100	DC/DC Current Transducer up to 100 A to 4..20 mA (Loop powered)
T201DCH	Current Transducer, up to 50A, Output 0-10V
T201DCH100	AC/DC TRMS Current Transducer, up to 100 A, Output 0-10V
T201DCH300	AC/DC TRMS Current Transducer, up to 300 A, Output 0-10V

**TOP PRODUCTS**

## T201DCH

Current Transducer,  
up to 50A, Output 0-10V



## T201DCH300

AC/DC TRMS  
Current Transducer,  
up to 300 A, Output 0-10V



## APPLICATION CASES

### SOLAR PANEL CURRENT MONITORING

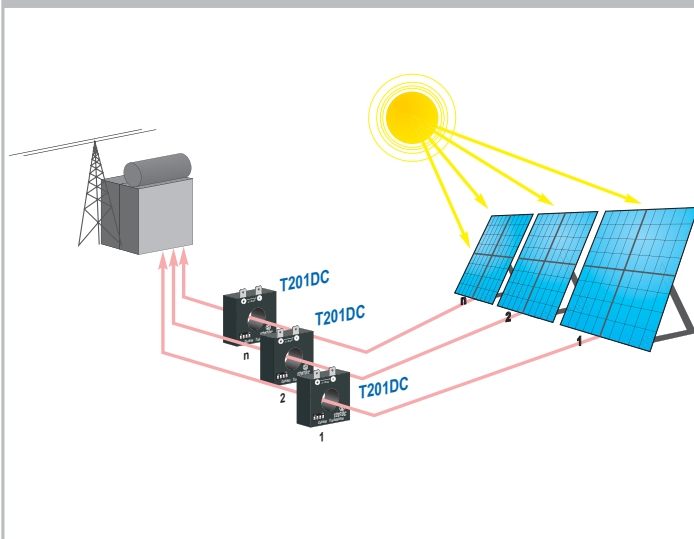

### MOTOR CONTROL MONITORING

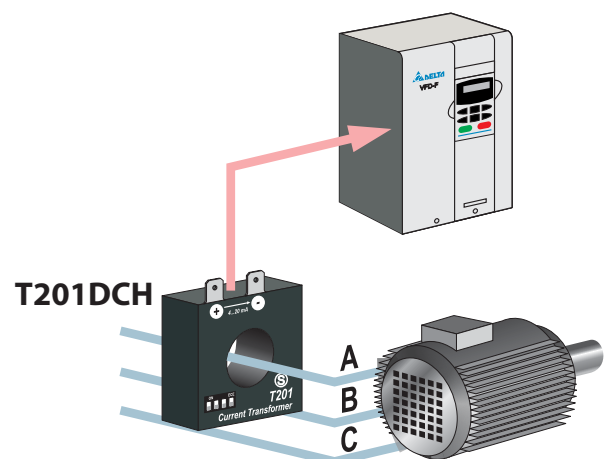

# POWER & ENERGY MANAGEMENT



## S504C

Three-phase energy counter,  
Input 80A, 4-wire  
(with communication interface)



**MID**  
MID CE 2004/22

## S501

Single-phase energy counter,  
Input 32A, 2-wire



**TOP PRODUCTS**

## S203RC-D

Three-phase Network Analyzer for Rogowski's sensor



## ORDER CODES

ORDER CODE	DESCRIPTION
S203RC-D	3-phase Network Analyzer for Rogowski's sensor
RC-V400-100	Rogowski Coil, output 100mV/kA, 50-60 Hz, Ø 115 mm, cable 2,5 m
S203T	3-phase network analyzer, 100 mA input
S203TA	3-phase Network analyzer to used with max 5 A CTs
S203TA-D	3-phase Network analyzer Up to 500 Vac/5A, with display
Z201	AC Current (5-10 A) to DC Current/Voltage
Z202	AC Voltage (500 A) to DC Current/Voltage
Z202-LP	AC / DC voltage to DC isolator / converter, loop powered
Z203-1	AC single phase advanced network analyzer
Z204-1	AC/DC voltage to DC current/voltage isolator/converter
T201	AC Current Transf. 5-40 A to 4..20 mA (Loop powered)
T201DC	DC Current Transf. 5-40 A to 4..20 mA (Loop powered )
T201DC100	DC/DC Current Transducer up to 100 A to 4..20mA (Loop powered)
T201DCH	AC/DC TRMS Current Transducer, up to 50 A, Output 0-10V
T201DCH100	AC/DC TRMS Current Transducer, up to 100A, output 0-10V
T201DCH300	AC/DC TRMS Current Transducer, up to 300A, output 0-10V
S511	Three phase power meter 96x96 DIN
S604	Three phase power meter 4 moduli DIN
RC150	Rogowski sensor with flexible core
S504C	Three-phase energy counter, Input 80A, 4-wire (with communication interface)
S502	Single-phase energy counter, Input 80A, 2-wire
S501	Single-phase energy counter, Input 32A, 2-wire
S500-MOD	ModBUS communication module
S500-MBUS	M-BUS communication module
S500-ETH	Ethernet communication module

## APPLICATION CASES

### 3-PHASE INPUT WITH ROGOWSKI SENSOR

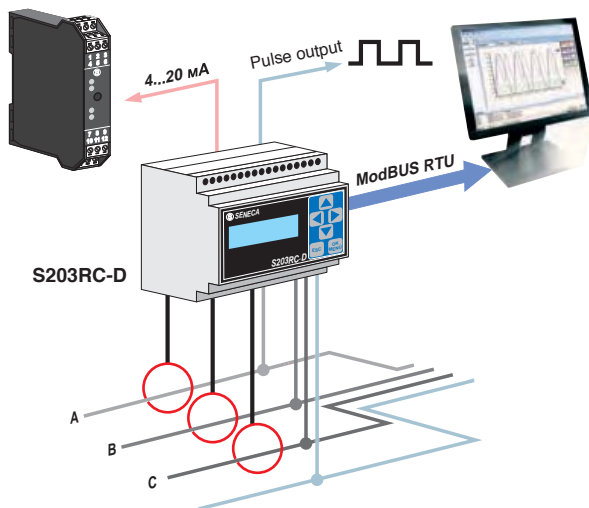



# TEMPERATURE CONVERTERS

## K109TC

Thermocouple converter with settable threshold



## T121

Isolated loop powered temperature transmitter



## ORDER CODES

ORDER CODE	DESCRIPTION
T120	Pt100/Ni100 to 4-20mA out (non-Isolated), B-Head mounting
T121	Universal Input to 4-20mA out (Isolated), B-Head mounting
K109PT	PT100 to DC Current/Voltage Isolator/Converter
K109PT-HPC	PT100 to DC Current/Voltage Isolator/Converter - High precision
K109PT1000	PT1000 to DC Current/Voltage Isolator/Converter
K109TC	TC to DC Current/Voltage Isolator/Converter-with alarm
Z109PT2	RTD (Pt100, Pt1000, Pt500, Ni100) to DC I/V Isolator/Converter
Z109TC2	TC to DC Current/Voltage Isolator/Converter
Z109REG2	Universal Isolator/Converter with alarm/strobe output
Z170REG	Universal converter with 2 analogue Isolated Output
Z-4RTD2	4 CH RTD input module / RS485 ModBUS RTU
Z-4TC	4 CH Thermocouple input module / RS485 ModBUS RTU
Z-8TC	8 CH Thermocouple input module / RS485 ModBUS RTU
ZC-4RTD	4 CH RTD (Pt100, Ni100, Pt500, Pt1000) input CANopen module
ZC-8TC	8 CH Thermocouple (J,K,E,N,S,R,B,T) CANopen module

TOP PRODUCTS

## Z109PT2

RTD to DC Current/Voltage Isolator/Converter



## Z-4RTD2

4-CH RTD input module / ModBUS RTU



## APPLICATION CASES

### THERMOCOUPLE CONVERSION / DISPLAYING AND ALARM MANAGEMENT

TC conversion / displaying through 315 alarm management

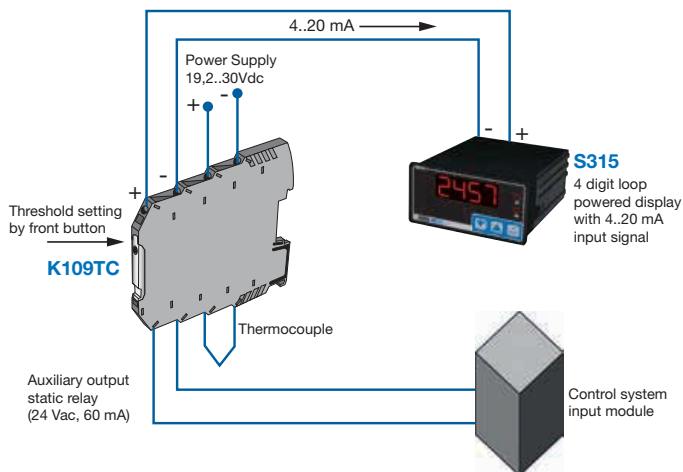

### REMOTE TEMPERATURE MONITORING

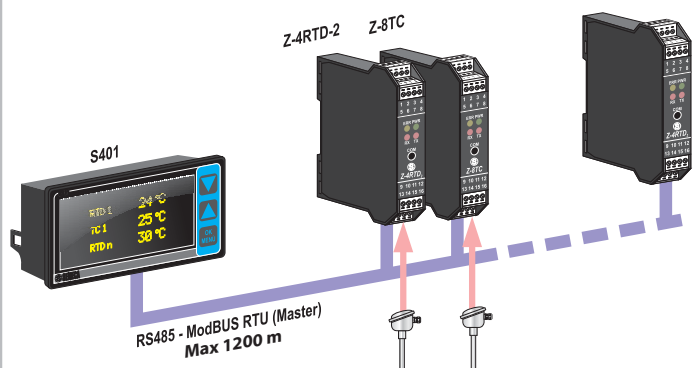

# SIGNAL SIMULATOR & MULTIMETER HANDHELD

## Test 4 - SIGNAL SIMULATOR & MULTIMETER HANDHELD FOR ANALOG SIGNALS



ORDER CODES	
ORDER CODE	DESCRIPTION
TEST-4	mV-V-mA generator & handheld meter
TEST-4/T	Certificated ISO 9001 calibration service
TEST-4-PK	Precision probes set with adapters and crocodile terminals



## APPLICATION CASES

### SIMULATION SIGNALS FROM THE FIELD

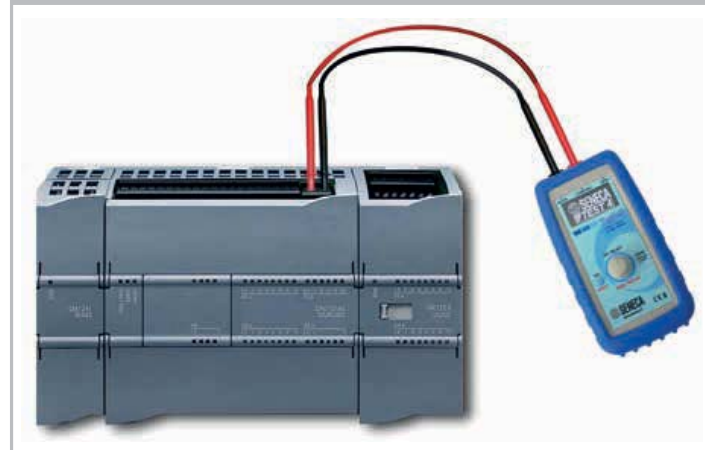

### CALIBRATION PROCESS FOR SENSORS, ACTUATORS, TURNING, PLC, REGULATORS, ETC.





[www.seneca.it](http://www.seneca.it)

## CONTACT AND INFORMATION

### Address

Headquarter: Via Austria 26 - 35127 Padova (I)  
Tel. +39 049 8705 359 (408)  
Fax +39 049 8706287

### Web

Automation Products: [www.seneca.it](http://www.seneca.it)  
Tech Support: [www.seneca.it/supporto](http://www.seneca.it/supporto)

### E-mail

General information: [info@seneca.it](mailto:info@seneca.it)  
Sales Office: [sales@seneca.it](mailto:sales@seneca.it)  
Quality Management: [qualita@seneca.it](mailto:qualita@seneca.it)  
Product technical support: [support@seneca.it](mailto:support@seneca.it)

