



Z-LINE

MULTISTANDARD SIGNAL CONVERTERS



Z-Line

Multistandard Signal Converters & Isolators

Z-Line Series offers a full range of signal conditioners including analog/digital/serial converters, temperature transmitters, galvanic isolators, splitters, trip amplifiers and math modules. They work at 10-40 Vdc/ 19-28 Vac, 85-265 Vac/dc or are supplied by the loop.

Z-Line modules ensure from 1.500 Vrms to 4.000 Vrms isolation voltage for 1 minute at three points. They also supply the transducer and can have active/passive input/output and they are designed to be mounted on DIN 46277 rail.



UNIVERSAL POWER SUPPLY

Vac/dc switching;
loop powered

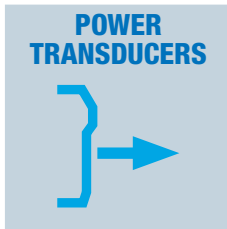

POWER TRANSDUCERS

Min 20 Vdc

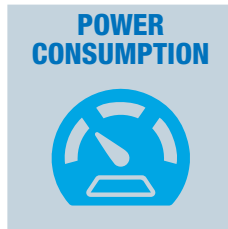

POWER CONSUMPTION

< 2,5 W

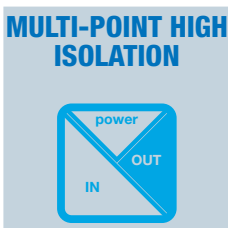

MULTI-POINT HIGH ISOLATION

From 1,5 kVac
up to 4kVac

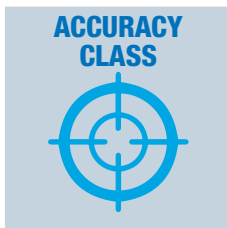

ACCURACY CLASS

up to 0,1%

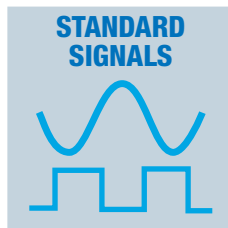

STANDARD SIGNALS

mA, mV, A, V, Ohm, RTD, TC, load cell, Reed, Pnp, Npn, Hall effect sensor, Photoelectric sensor, pulse 24V



STRENGTH

Operating temperature
up to -20..+65%, RH
90%



RELIABILITY

MTBF>500.000 h



APPROVALS

CE UL LISTED CUL US

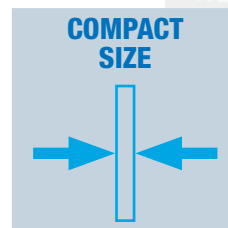

COMPACT SIZE

Width 17.5 mm /35 mm

SENECA Z-Line offers three setting options. Almost all of the existing models allows configuration of standard parameters using the dip switches on board. In addition to the standard configuration some models can be configured for wider functionalities by using the PC software "EASY SETUP". Moreover, certain models are equipped with a frontal Micro USB port for an easier configuration through "EASY SETUP APP", a specific App for Android.

FLEXIBLE CONFIGURATION

DIP Switch







Software EASY SETUP

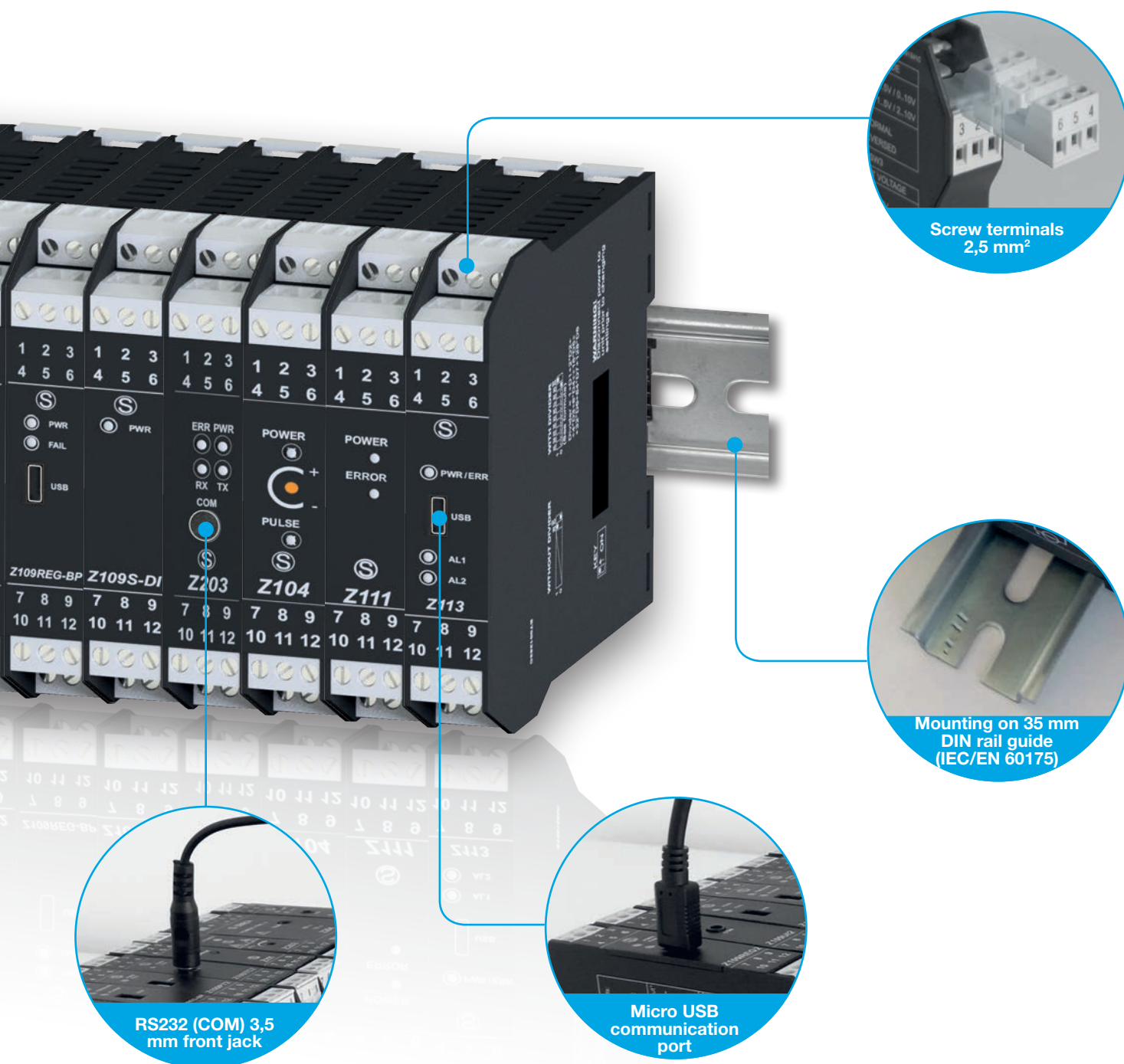





EASY SETUP APP







ANALOG CONVERTERS



	Z109REG	Z109REG2-1	Z109REG2-H
	 <p>Universal isolator/converter</p>	  <p>Universal isolator/converter with advanced functions</p>	 <p>High performance universal converter, 85-265 V</p>
GENERAL DATA			
Power Supply	10..40 Vdc; 19..28 Vac; (50..60 Hz)	9..40 Vdc; 19..28 Vac; (50..60 Hz)	85..265 Vac/dc
Power transducers	Active input 2 wire (min 18 Vdc)	Active input 2 wire (min 20 Vdc)	Active input 2 wire (min 20 Vdc)
Power Consumption	2.5 W	2.5 W (max) 1.6 W (24 Vdc, 20 mA)	2.5 W (max) 1.6 W (24 Vdc, 20 mA)
Isolation	1.500 Vac, 3 way Against surge pulses 400W/ms	1.500 Vac, 3 way 3.750 Vac (power supply / input -output) Against surge pulses 400W/ms	1.500 Vac, 3 way 3.750 Vac (power supply / input -output) Against surge pulses 400W/ms
Status indicators	Power supply Error	Power supply Error Alarm	Power supply Error Alarm
Response time	35 ms	35 ms (11 bit)..140 ms (16 bit)	35 ms (11 bit)..140 ms (16 bit)
Interface	3,5mm front jack RS232 (COM)	Micro USB	3,5 mm front jack RS232 – COM
Accuracy	0,1%	0,1%	0,1%
Thermal drift	0.01%/°K	0.01%/°K	0.01%/°K
Linearity	0,05% (V,I), 0,2% (RTD), 1°C (TC)	0,05% / 0.4%	0,05% / 0.4%
Settings	Dip-switches Software (EASY SETUP)	Dip-switches Software / App (EASY SETUP)	DIP-switches Software (EASY SETUP)
Operating Temperature	-20..+60°C	-20..+60 °C	-20..+60 °C
Dimensions (w x h x d)	17,5 x 100 x 112 mm	17,5 x 100 x 112 mm	17,5 x 100 x 112 mm
Connections	Removable 3-way screw terminals, 5 mm pitch. cable section's 0.25-2.5 mm ²	Removable 3-way screw terminals, 5 mm pitch. cable section's 0.25-2.5 mm ²	Removable 3-way screw terminals, 5 mm pitch. cable section's 0.25-2.5 mm ²
Weight	200 g	200 g	200 g
Approvals	CE	CE- UL-UR CSA	CE
Norms	EN 50081-1, EN 50082-2, EN 61010-1	EN 61000-6-4 / 2002, EN 61000-2-2/2005 / EN 61010-1, EN 60742	EN 61000-6-4 / 2002, EN 61000-2-2/2005 / EN 61010-1, EN 60742
INPUT DATA			
Channels	1	1 analog 1 strobe	1 analog 1 strobe
Type	VOLTAGE Bipolar 0..2, 0..5, 0..10 V CURRENT Bipolar 0..20 mA RTD Pt100 (-200..+600°C) THERMOCOUPLE Tipo J, K, R, S, T, E, B, N POTENTIOMETER 0,5..15 kΩ	VOLTAGE Bipolar from 75 mV to 20 V Resolution 15 bit + sign CURRENT Bipolar up to 20 mA Resolution 1 μA RTD Pt100, Pt500, Pt1000, Ni100, KTY81, KTY84, NTC Measure 2, 3, 4 wires Range: -200..600 °C Resolution 0,1°C THERMOCOUPLE Type J, K, R, S, T, E, B, N Resolution 2,5 μV POTENTIOMETER: 500 Ω ..100 kΩ RHEOSTAT: 500 Ω ..25 kΩ STROBE: alternative to the relay output	VOLTAGE Bipolar from 75 mV to 20 V Resolution 15 bit + sign CURRENT Bipolar up to 20 mA Resolution 1 μA RTD Pt100, Pt500, Pt1000, Ni100, KTY81, KTY84, NTC Measure 2, 3, 4 wires Range: -200..600 °C Resolution 0,1°C THERMOCOUPLE Type J, K, R, S, T, E, B, N Resolution 2,5 μV POTENTIOMETER: 500 Ω ..100 kΩ RHEOSTAT: 500 Ω ..25 kΩ STROBE: alternative to the relay output
OUTPUT DATA			
Channels	1	1 analog, 1 relay	1 analog, 1 relay
Type	VOLTAGE 4 scales: 0..1, 0..5, 0..10, 2..10 V CURRENT 2 scales: 0/4..20 mA	VOLTAGE 4 scales: 0..1, 0..5, 0..10, 2..10 V Min load resistance: 2.000 Ω CURRENT 2 scales: 0/4..20 mA (active/passive) Max load resistance: 600 Ω RELAY Alternative to the strobe NC / NA in case of alarm	VOLTAGE 4 scales: 0..1, 0..5, 0..10, 2..10 V Min load resistance: 2.000 Ω CURRENT 2 scales: 0/4..20 mA (active/passive) Max load resistance: 600 Ω RELAY Alternative to the strobe NC / NA in case of alarm
ORDER CODES	Z109REG	Z109REG2-1	Z109REG2-H

Z109UI2-1	Z109REG-BP	Z109S-DI	Z109S
    <p>DC Current/Voltage to DC Current/ Voltage isolator/converter</p>	   <p>Universal converter with isolated bipolar output</p>	 <p>Wide range Current Loop Isolator</p>	  <p>DC Current isolator</p>
10..40 Vdc 19..28 Vac (50..60 Hz)	10..40 Vdc 19..28 Vac (50..60 Hz)	10..40 Vdc 19..28 Vac (50..60 Hz)	9..40 Vdc 19..28 Vac; (50..60 Hz)
Active input 2 wire (min 20 Vdc)	Active input 2 wire (17 Vdc)	Active input 2 wire (17 Vdc)	Active input 2 wire (min 20 Vdc)
2.5 W	2.5 W	2.5 W	2,5W
1.500 Vac, 3 way Against surge pulses 400W/ms	1.500 Vac, 3 way	3.500 Vac, 3 way	1.500 Vac, 3 way
Power supply	Power supply Error Alarm	Power supply	Power supply
35 ms (11 bit)..140 ms (16 bit) 3,5mm front jack RS232 (COM) Micro USB	35 ms (11 bit)..140 ms (16 bit) Micro USB	< 200 us -	< 60 ms
0,1%	0,1%	0,2% or 10 uA	0,20%
0.01%/°K	0.01%/°K	0.02%/°K	0,02 % f.s. / °C
0,05 % (V _I), 0,01% (V _{out})			0,05%
Dip-switches Jumper Software / App (EASY SETUP)	Dip-switches Software / App (EASY SETUP) Jumper		
-10..+60 °C	-20..+65°C	-20..+60°C	-20..+60°C
17,5 x 100 x 112 mm	17,5 x 100 x 112 mm	17,5 x 100 x 112 mm	17,5 x 100 x 112 mm
Removable 3-way screw terminals, 5 mm pitch. cable section's 0.25-2.5 mm ²	Removable 3-way screw terminals, 5 mm pitch. cable section's 0.25-2.5 mm ²	Removable 3-way screw terminals, 5 mm pitch. cable section's 0.25-2.5 mm ²	Removable 3-way screw terminals, 5 mm pitch. cable section's 0.25-2.5 mm ²
200 g	200 g	200 g	200 g
CE- UL-UR CSA EN 55011, EN 61000-4-2, EN 61000-4-4, EN 50140 / 141	CE EN 61000-6-2; EN 61000-6-4; EN 61010-1	CE EN 61000-6-2; EN 61000-6-4; EN 61010-1	CE - UL EN 55011, EN 61000-4-2, EN 61000-4-4, EN 50140 / 141
1	1	1	1
VOLTAGE Bipolar da 75 mV a 20 V Resolution 15 bit + sign CURRENT Bipolar up to 20 mA Resolution 1 µA	VOLTAGE Bipolar from 75 mV to 20 V CURRENT Bipolar up to 20 mA RTD Pt100, Pt500, Pt1000, Ni100, KTY81,KTY84, NTC Measure 2,3, 4 wires THERMOCOUPLE Type J, K, R, S, T, E, B, N POTENTIOMETER: 500 Ω ..100 kΩ RHEOSTAT: 500 Ω..25 kΩ	CURRENT 0 - 20 mA or 4 - 20 mA	CURRENT 2 scales: 0/4..20 mA
1	1	1	1
VOLTAGE 4 scales: 0..1, 0..5, 0..10, 2..10 V Min load resistance: 2.000 Ω CURRENT 2 scales: 0/4..20 mA (active/passive) Max load resistance: 600 Ω	CURRENT -20 – +20 mA Maximum load resistance 500Ω VOLTAGE -10 – +10 V Minimum load resistance 1 k Ω	CURRENT 0 - 20 mA or 4 - 20 mA Max load 600 Ω	CURRENT 2 scales: 0/4..20 mA Max resistance load: 600 Ω
Z109UI2-1	Z109REG-BP	Z109S-DI	Z109S

ANALOG CONVERTERS







	Z102	Z110S	Z110D	Z170REG-1
				 EASY SETUP UL Android
	Potentiometer to DC current / voltage isolator / convertor	DC current insulator (self-powered) single channel	DC current insulator (self-powered) double channel	DC duplicator isolator with universal input, 2-CH output, micro USB
GENERAL DATA				
Power Supply	9..30 (option) - 19..40 Vdc; 19..28 Vac	Self-powered by input loop	Self-powered by input loop	10..40 Vdc; 19..28 Vac
Power transducers				Yes, max 25 mA, 17 Vdc
Power consumption (max)	2,5 W			0,5..2 W
Isolation	1.500 Vac (3 ways)	1.500 Vac	1.500 Vac	1.500 Vac (4 vie)
Protection degree	IP20	IP20	IP20	IP20
LED status indicators	Power Supply			Power Supply Alarm
Response time	< 40 ms	< 100 ms	< 100 ms	< 25 ms
Interface				Micro USB
PLC communication				
Accuracy class	0,2%	0,1%	0,1%	0,1%
Thermal Drift	0,02 % f.s. / °C	0,02 % f.s. / °C	0,02 % f.s. / °C	0,01% /K
Linearity	0,05%	0,1 % f.s.	0,1 % f.s.	<1% (input), 0,01% (output)
Settings	DIP switch			DIP switch Software (EASY SETUP) App (EASY SETUP)
Operating temperature	0..+50°C	0..+50°C	0..+50°C	-10..+65°C
Dimension	17,5 x 100 x 112 mm	17,5 x 100 x 112 mm	17,5 x 100 x 112 mm	17,5 x 100 x 112 mm
Connection	Removable 3-way screw terminals, 5 mm pitch, cable section 0,25-2,5 mm ²	Removable 3-way screw terminals, 5 mm pitch, cable section 0,25-2,5 mm ²	Removable 3-way screw terminals, 5 mm pitch, cable section 0,25-2,5 mm ²	Removable 3-way screw terminals, 5 mm pitch, cable section 0,25-2,5 mm ²
Case	Nylon 6 30% glass fiber	Nylon 6 30% glass fiber	Nylon 6 30% glass fiber	Nylon 6 30% glass fiber
Mounting	35 mm DIN rail (IEC/EN 60715)	35 mm DIN rail (IEC/EN 60715)	35 mm DIN rail (IEC/EN 60715)	35 mm DIN rail (IEC/EN 60715)
Weight	200 g	200 g	200 g	200 g
Approvals	CE	CE	CE	CE, UL
Norms	EN 61000-6-4, EN 61000-6-2, EN 61010-1	EN 61000-6-4, EN 61000-6-2, EN 61010-1	EN 61000-6-4, EN 61000-6-2, EN 61010-1	EN 61000-6-4, EN 61000-6-2, EN 61010-1
INPUT DATA				
Channels	1	1	2	1
Type	<ul style="list-style-type: none"> • RHEOSTAT 2 wires: 0..300 Ω (I=6mA); 0..500 Ω (I=3,6 mA); 0..1 K Ω (I=1,8 mA) • POTENTIOMETER 3 wires: Vref=1,8 Vcc, from 200 Ω to 1 M Ω 	<ul style="list-style-type: none"> • CURRENT (mA) 4..20 mA 	<ul style="list-style-type: none"> • CURRENT (mA) 4..20 mA 	<ul style="list-style-type: none"> • VOLTAGE (V) settable scale: 0..10 V • CORRENT (mA): settable scale: 0..20 mA (active/passive module) • POTENTIOMETER settable scale: 1 kΩ ..100 kΩ • THERMOCOUPLE: J,K,R,S,T,B,E,N • THERMORESISTANCE: Pt100, Pt500, Pt1000, Ni100 Resolution 14 bit Settable sampling time from 5 to 20 ms
OUTPUT DATA				
Channels	1	1	2	2
Type	<ul style="list-style-type: none"> • VOLTAGE (V) 4 scale: 0..5, 1..5, 0..10, 0..10 V Load impedance > 2,5 K Ω • CURRENT (mA) 2 scales: 0..20, 4..20 mA Loop impedance < 600 Ω 	<ul style="list-style-type: none"> • CURRENT (mA) 4..20 mA 	<ul style="list-style-type: none"> • CURRENT (mA) 4..20 mA 	<ul style="list-style-type: none"> • VOLTAGE (V) settable scale: 0..10 V • CURRENT (mA) settable scale: 0..20 mA (active/passive) Resoluion 14 bit
ORDER CODES	Z102	Z110S	Z110D	Z170REG-1

ELECTRIC METER CONVERTERS

	Z201	Z201-H	Z202
			
	AC Current isolator converter, 10..40 Vdc;19..28Vac	AC Current isolator converter, 85..265 V	AC Voltage isolator converter, 10..40 Vdc;19..28Vac
GENERAL DATA			
Power Supply	10..40 Vdc; 19..28 Vac	85..265 Vac/dc	10..40 Vdc; 19..28 Vac
Power Consumption	< 2,5 W	< 2,5 W	< 1,5 W
Isolation	3750 Vac input/output and input/power supply; 1500 Vac output/power supply.	4000 Vac input/power supply; 4000 Vac output/power supply.	3750 Vac input/output and input/power supply; 1500 Vac output/power supply.
Status indicators	Power supply	Power supply	Power supply
Interface			
Response time	<200ms	<100ms.	30ms.
Accuracy	0,3%	0,3%	0,25%
Thermal drift	+200 ppm/K	+200 ppm/K	+150 ppm/K
Operating Temperature	0..+55°C	-10..+65°C	0..+60°C
Dimensions (w x h x d)	17,5 x 100 x 112 mm	17,5 x 100 x 112 mm	17,5 x 100 x 112 mm
Connections	Removable 3-way screw terminals, 5 mm pitch. cable section's 0.25-2.5 mm ²	Removable 3-way screw terminals, 5 mm pitch. cable section's 0.25-2.5 mm ²	Removable 3-way screw terminals, 5 mm pitch. cable section's 0.25-2.5 mm ²
Weight	200 g	200 g	200 g
Settings	Dip-switch Jumper (Output range)	Dip-switch Jumper (Output range)	Dip-switch Jumper (Output range)
Approvals	CE	CE	CE
Norms	EN 61000-6-4, EN 61000-6-2, EN 61010-1, EN 60742, IEC 61131	EN 61000-6-4, EN 61000-6-2, EN 61010-1, EN 60742, IEC 61131	EN 60688+A1+A2, EN 61000-6-4, EN 61000-6-2, EN 61010-1, EN 60742, IEC 61131
INPUT DATA			
Nr	1	1	1
Type	AC CURRENT 0..5 / 0..10 A ac	AC CURRENT 0..5 / 0..10 A ac	AC VOLTAGE 0..500 Vac Input impedance: 2000 Ω /V Frequency: 10 Hz..1 kHz
OUTPUT DATA			
Channels	1	1	1
Type	CURRENT Active or passive: 0..20 mA or 4..20 mA * Maximum load resistance 600 Ohm VOLTAGE 0..5 V, 1..5 V, 0..10 V, 2..10 V Minimum load resistance: 2500 Ohm	CURRENT Active or passive: 0..20 mA or 4..20 mA * Maximum load resistance 600 Ohm VOLTAGE 0..5 V, 1..5 V, 0..10 V, 2..10 V Minimum load resistance: 2500 Ohm	CURRENT Active or passive: 0..20 mA or 4..20 mA Maximum load resistance 600 Ohm VOLTAGE 0..5 V, 1..5 V, 0..10 V, 2..10 V Minimum load resistance: 2500 Ohm
ORDER CODES	201	Z201-H	Z202











Z202-H	Z202-LP	Z203-1	Z204-1
		  	 
AC Voltage isolator converter, 85..265 V	AC/DC Voltage isolator converter, loop powered	Single phase power meter	AC/DC voltage isolator converter TMRS
85..265 Vac/dc	Self-powered from the input loop	10..40 Vdc 19..28 Vac (50..60 Hz) < 2,5 W	10..40 Vdc 19..28 Vac (50..60 Hz) 1 W
< 1,5 W	< 1mA		
4.000 Vac input/power supply 4.000 Vac output/power supply Power supply	4000 Vac input/output Power supply	3750 Vac input/output/power supply Power Supply, Error, RS485 communication	4000 Vac input/power supply and input/output 1500 Vac output/power supply Power Supply, Error, RS485 communication
		RS485 (backplane), 1200..115200 Baud bps, ModBUS RTU protocol RS232 (jack stereo 3.5 mm front connector for configuration): baud rate, address, parity, data/stop bit	RS485 (backplane), 1200..115200 Baud bps, ModBUS RTU protocol RS232 (jack stereo 3.5 mm front connector for configuration): baud rate, address, parity, data/stop bit
<100ms.	< 100 ms	< 10 ms	For a step variation: 1s from 10 to 90 %.
0,3%	0,3%	0,5%	0,5% input; 0,1% outputs.
+150 ppm/K	+150 ppm/K	+150 ppm/K	+100 ppm/K
-10..+65°C	-20..+65°C	-10..+65°C	-20..+65°C
17,5 x 100 x 112 mm	17,5 x 100 x 112 mm	17,5 x 100 x 112 mm	35 x 100 x 112 mm
Removable 3-way screw terminals, 5 mm pitch. cable section's 0.25-2.5 mm ²	Removable 3-way screw terminals, 5 mm pitch. cable section's 0.25-2.5 mm ²	Removable 3-way screw terminals, 5 mm pitch. cable section's 0.25-2.5 mm ² RS485 bus connection	Removable 3-way screw terminals, 5 mm pitch. Standard 4 mm banana sockets RS485 bus connection Frontal jack 3.5 mm for module configuration
200 g	140 g	140 g	140 g
Dip-switch Jumper (Output range)	Dip-switch (Input range)	Dip-switch (address, baud rate, line terminator, input range) EASY-SETUP (Plug&Play software)	Dip-switch (address, baud rate, line terminator, input range) EASY-SETUP (Plug&Play software)
CE	CE	CE - UL	CE
EN 60688+A1+A2, EN 61000-6-4, EN 61000-6-2, EN 61010-1, EN 60742, IEC 61131	EN 61000-6-4, EN 61000-6-2, EN 61010-1, EN 60742, IEC 61131	EN 61000-6-4, EN 61000-6-2, EN 61010-1, EN 60742, IEC 61131	EN 61000-6-4, EN61000-6-2, EN61010-1
1	1	1 (single phase load)	1
AC VOLTAGE 0..500 Vac Input impedance: 2000 Ω /V Frequency: 10 Hz..1 kHz	AC VOLTAGE 0..500 Vac DC VOLTAGE 0..540 Vdc Maximum Voltage 710 Vpk Frequency DC / 20 Hz..400 Hz	AC VOLTAGE Up to 500 Vac, frequency 35 to 75 Hz. AC CURRENT Input range: 5 Arms, Max peak factor 3, Max Current 15 A, Frequency 35 to 75 Hz.	DC VOLTAGE 0..1200 Vdc Input impedance 4 MΩ AC VOLTAGE 0..850 Vac Input impedance 4 MΩ Frequency 30Hz – 60Hz
1	1	1 analog, 1 digital	1
CURRENT Active or passive: 0..20 mA or 4..20 mA Maximum load resistance 600 Ohm VOLTAGE 0..5 V, 1..5 V, 0..10 V, 2..10 V Minimum load resistance: 2500 Ohm	CURRENT Passive, 4..20 mA	CURRENT 0..20 mA, 4..20 mA, maximum load resistance 500 Ohm VOLTAGE 0..10 Vdc, 0..5 Vdc, minimum load resistance 2000 Ohm DIGITAL Passive digital Output for pulses (energy counter)	CURRENT 0..20 mA, 4..20 mA, maximum load resistance 500 Ohm VOLTAGE 0..10 Vdc, 0..5 Vdc, minimum load resistance 2000 Ohm DIGITAL Passive digital Output for pulses (energy counter)
Z202-H	Z202-LP	Z203-1	Z204-1

RELAYS CONDITIONERS

	Z112A	Z112D	Z113S	Z113D	Z113T	Z113-1
						
	On/Off sensors digital amplifier, single channel	On/Off sensors digital amplifier, double channel	DC Current / Voltage alarm trip module, 1 relay output	DC Current / Voltage alarm trip module, 2 relay output	DC Current / Voltage alarm trip module, 3 relay output	Double threshold with universal analog input
GENERAL DATA						
Power Supply	19..40 (9..30 opt.) Vdc; 19..28 Vac; (50..60 Hz)	19..40 (9..30 opt.) Vdc; 19..28 Vac; (50..60 Hz)	19..40 (9..30 opt.) Vdc; 19..28 Vac; (50..60 Hz)	19..40 (9..30 opt.) Vdc; 19..28 Vac; (50..60 Hz)	19..40 (9..30 opt.) Vdc; 19..28 Vac; (50..60 Hz)	10-40 Vdc, 19-28 Vac (50 - 60 Hz)
Power transducers	Yes, active input 2 wire (min 20 Vdc)	Yes, active input 2 wire (min 20 Vdc)	Yes, active input 2 wire (min 20 Vdc)	Yes, active input 2 wire (min 20 Vdc)	Yes, active input 2 wire (min 20 Vdc)	Yes, active input 2 wire
Power Consumption	2.5 W	2.5 W	2.5 W	2.5 W	2.5 W	2.5 W
Isolation	1.500 Vac (power supply/input) 4.000 Vac (input/power supply/output)	1.500 Vac	1.500 Vac (power supply/input) 4.000 Vac (input/power supply/output)	1.500 Vac	1.500 Vac	1.500 Vac, 3 way
Status indicators	Power Supply Relay	Power Supply Relay	Power Supply Overtaking limit	Power Supply Overtaking limit	Power Supply Overtaking limit	Power supply Alarm
Interface						Micro USB frontal plug
Response time						
Accuracy	±0,01% /°C	±0,01% /°C	±0,01% /°C	±0,01% /°C	±0,01% /°C	0.01%/°K
Thermal drift						
Linearity			0,05%	0,05%	0,05%	
Settings	Dip-switches: input type, output retransmission, divider circuit settable from 1 to 256 Trimmer: pulse duration (100..500ms)	Dip-switches: input type, output retransmission, divider circuit settable from 1 to 256 Trimmer: pulse duration (100..500ms)	DIP switches: input type, functions (relays activation, min/max value alarm) Trimmer: Setpoint alarms (1..100% signal control) Delay (0,3..30 s) Hysteresis (2..15% of full-scale)	DIP switches: input type, functions (relays activation, min/max value alarm) Trimmer: Setpoint alarms (1..100% signal control) Delay (0,3..30 s) Hysteresis (2..15% of full-scale)	DIP switches: input type, functions (relays activation, min/max value alarm) Trimmer: Setpoint alarms (1..100% signal control) Delay (0,3..30 s) Hysteresis (2..15% of full-scale)	Dip-switches: input type, output, start scale, end scale. EASY SETUP software (all parameters)
Operating Temperature	0..+50 °C	0..+50 °C	0..+50 °C	0..+50 °C	0..+50 °C	-10...+65°C
Dimensions (w x h x d)	17,5 x 100 x 112 mm	17,5 x 100 x 112 mm	17,5 x 100 x 112 mm	17,5 x 100 x 112 mm	17,5 x 100 x 112 mm	17,5 x 100 x 112 mm
Connections	Removable 3-way screw terminals, 5 mm pitch. cable section's 0.25-2.5 mm ²	Removable 3-way screw terminals, 5 mm pitch. cable section's 0.25-2.5 mm ²	Removable 3-way screw terminals, 5 mm pitch. cable section's 0.25-2.5 mm ²	Removable 3-way screw terminals, 5 mm pitch. cable section's 0.25-2.5 mm ²	Removable 3-way screw terminals, 5 mm pitch. cable section's 0.25-2.5 mm ²	Removable 3-way screw terminals, 5 mm pitch. cable section's 0.25-2.5 mm ²
Weight	200 g	200 g	200 g	200 g	200 g	200 g
Approvals	CE	CE	CE	CE	CE	CE
Norms	EN 50081-1, EN 50082-2, EN 61010-1	EN 50081-1, EN 50082-2, EN 61010-1	EN 50081-1, EN 50082-2, EN 61010-1	EN 50081-1, EN 50082-2, EN 61010-1	EN 50081-1, EN 50082-2, EN 61010-1	EN61000-6-4; EN61000-6-2, EN 61010-1
INPUT DATA						
Channels	1	2	1	1	1	1
Type	PULSES Contact optoisolated Reed npn 2/3 wires- 12..24 Vdc, pnp 3 wires, power supply 24 Vdc Namur Pulses 24 Vdc Photoelectric sensor Hall effect sensor Max frequency 400 Hz	PULSES Contact optoisolated Reed npn 2/3 wires- 12..24 Vdc, pnp 3 wires, power supply 24 Vdc Namur Pulses 24 Vdc Photoelectric sensor Hall effect sensor Max frequency 10 Hz	CURRENT: 0..20, 4..20 mA active/passive Input impedance 100 Ω VOLTAGE: 0.5, 1..5, 0..10, 2..10 Vdc Input impedance : 500 KΩ	CURRENT: 0..20, 4..20 mA active/passive Input impedance 100 Ω VOLTAGE: 0.5, 1..5, 0..10, 2..10 Vdc Input impedance : 500 KΩ	CURRENT: 0..20, 4..20 mA active/passive Input impedance 100 Ω VOLTAGE: 0.5, 1..5, 0..10, 2..10 Vdc Input impedance : 500 KΩ	VOLTAGE up to 10 V Bipolar current up to 20 mA THERMORESISTANCE: Pt100, Pt500, Pt1000, Ni100 THERMOCOUPLE type: J,K,R,S,T,B,E,N POTENTIOMETER up to 100 kΩ
OUTPUT DATA						
Channels	1	2	1	2	3	2
Type	RELAY SPDT 1A - 30Vdc; 5A - 250Vac (resistive load)	RELAY SPST max load 5A - 250V (resistive load)	Relay SPDT, 1A - 30Vdc; 5A - 250Vac (resistive load)	Relay SPST, max load 0,1A - 30Vac/dc (10VA resistive load)	Relay SPST, max load 0,1A - 30Vac/dc (10VA resistive load)	RELAYS SPST N.O. position with common Max RELAY current 3 A@ 250V; 3 A@ 30V Max RELAY voltage 250 V CAT. II
ORDER CODES	Z112A	Z112D	Z113S	Z113D	Z113T	Z113-1

TEMPERATURE CONVERTERS

FREQUENCY CONVERTERS

	Z109PT2-1	Z109TC2-1	Z104	Z111
	    <p>RTD to DC Current/Voltage isolator/converter</p>	    <p>TC to DC Current/Voltage isolator/converter</p>	 <p>DC current / voltage to frequency isolator / converter</p>	  <p>Frequency to DC current / voltage isolator / converter</p>
GENERAL DATA				
Power Supply	9..40 Vdc 19..28 Vac; (50..60 Hz)	9..40 Vdc 19..28 Vac; (50..60 Hz)	19 - 40 Vdc, 19 - 28 Vac (50 - 60 Hz)	19 - 40 Vdc, 19 - 28 Vac (50 - 60 Hz)
Power transducers			supply of the sensor with 2-wire method: 20VDC stabilized	
Power Consumption	2.5 W	2 W	2.5 W	2.5 W
Isolation	1.500 Vac, 3 way	1.500 Vac, 3 way	1.500 Vac, 3 way	1.500 Vac, 3 way
Status indicators	Power supply, Out of range, Setting error	Power supply, Out of range, Setting error	Power supply Output (relay)	Power Supply Error
Interface	Micro USB	Micro USB	-	-
Response time	140 ms Sampling frequency: 15 bits + sign resolution.	35 ms with 11 bit resolution, 140 ms with 16 bit resolution.	350 ms	250 ms
Accuracy	0,1% (RTD) – 0.3% (voltage output)	0,1% (TC) – 0.3% (voltage output)	0,20%	0,30%
Thermal drift	0.01%/°K	0.01%/°K	0,02 % f.s. / °C	0,01 % f.s. / °C
Settings	Dip-switches: range and input type; output selecting Software / App (EASY SETUP)	Dip-switches: range and input type; output selecting Software / App (EASY SETUP)	Dip-switches: input type, output, end scale Trimmer: end scale settings, integration constant	Dip-switches: input type, filter, pulses average, output Trimmer: end scale settings (1 Hz..10KHz)
Operating Temperature	-10..+60°C	-10..+60°C	0..+50 °C	0..+50 °C
Dimensions (w x h x d)	17,5 x 100 x 112 mm	17,5 x 100 x 112 mm	17,5 x 100 x 112 mm	17,5 x 100 x 112 mm
Connections	Removable 3-way screw terminals, 5 mm pitch, cable section's 0.25-2.5 mm ²	Removable 3-way screw terminals, 5 mm pitch, cable section's 0.25-2.5 mm ²	Removable 3-way screw terminals, 5 mm pitch, cable section's 0.25-2.5 mm ²	Removable 3-way screw terminals, 5 mm pitch, cable section's 0.25-2.5 mm ²
Weight	200 g	200 g	200 g	200 g
Approvals	CE- UL-UR CSA	CE- UL-UR CSA	CE	CE- UL-UR CSA
Norms	EN 55011, EN 61000-4-2, EN 61000-4-4, EN 50140 / 141	EN61000-6-4, EN61000-6-2, EN61010-1	EN50081-2, EN50082-2, EN61010-1	EN50081-2, EN50082-2 EN61010-1
INPUT DATA				
Nr	1	1	1	1
Type	RTD PT100, PT500, PT1000, NI100 2, 3 or 4 wires measurement, energising current 1 mA, resolution 0.1 °C	TC Type J, K, R, S, T, B, E, N; resolution 2.5 µV, automatic TC burn out detection, input impedance > 5MΩ	VOLTAGE: 0 - 5 Vdc, 1 - 5 Vdc, 0 - 10 Vdc and 2 - 10 Vdc Input impedance 1 MΩ CURRENT: 0 - 20 mA or 4 - 20 mA, both active and passive connection. Active connection : loop supply voltage approx. 15 Vdc Passive connection : input impedance 100 Ω	PULSES Mechanical contact, reed, npn with 2 and 3 wires , pnp with 3 wires and 24V DC power supply, Namur, photoelectric, "HALL" sensor, and variable reluctance. Maximum frequency 10 KHz
OUTPUT DATA				
Channels	1	1	1	1
Type	VOLTAGE: 0..5 V / 0..10 V / 1..5 V / 2..10 V, min load resistance 2 kΩ Resolution: 2.5 µA/ 1.25mV. CURRENT: 0..20 / 4..20 mA, max load resistance 600 Ω Resolution: 2.5 µA/ 1.25mV.	VOLTAGE: 0..5 V / 0..10 V / 1..5 V / 2..10 V, min load resistance 2 kΩ Resolution: 2.5 µA/ 1.25mV. CURRENT : 0..20 / 4..20 mA, max load resistance 600 Ω	PULSE Npn open-collector transistor 30 Vdc 300 mA Max frequency: 10 kHz Reed-relay 30 Vdc-ac 100 mA. Frequency below 40 Hz	VOLTAGE: 0..5 V / 0..10 V / 1..5 V / 2..10 V , Min. load resistance: 25 kΩ CURRENT: 0/4..20 mA (active/passive) Max load resistance: 600 Ω
ORDER CODES	Z109PT2-1	Z109TC2-1	Z104	Z111

SOFTWARE & ACCESSORIES

EASY SETUP

Plug&Play Software



Programmable modules:
Z109REG, Z109REG2-1, Z109UI-2, Z109REG-BP,
Z170REG-1, Z-SG, Z203-1, Z204-1, Z113-1,
Z109PT2-1, Z109TC2-1

Minimum hardware requirements:
CPU 1GHz, 256 MB available, graphic video
resolution 1024x769pixel

Free download: www.seneca.it

- Automatic connection to the module
- Operating and communication parameters setting
- Parameters monitoring
- Modules automatic configuration
- Configuration test and duplication

EASY SETUP APP

Configuration App for Android terminals



Programmable modules:
Z109REG2-1, Z109UI2-1,
Z109REG-BP, Z170REG-1, Z109PT2-1, Z109TC2-1

Android version: 4.0 or later

Supported terminals: Android Smartphone/with
OTG functions

Download: Google Play Store

- Automatic connection to the module
- Operating and communication parameters setting
- Parameters monitoring
- Modules automatic configuration
- Configuration test and duplication

S117P1

RS232/USB, TTL/USB and RS485/USB Asynchronous Serial Converter



- USB standard 1.0, 1.1 e 2.0 compatible.
- 12 Vdc @ 100 mA available from screw terminals to supply a Seneca module.
- Power supply through USB.
- Serial RS485 Communication, max 32 nodes.
- More S117P1 can be connected on the the same PC.
- Accessories: CD with drivers, USB cable, TTL cable + EASYLP (programming Software for loop powered device)

ORDER CODES

Code	Description
S117P1	RS232/USB, TTL/USB, RS485/USB asynchronous serial converter

LOAD CELL CONNECTION AND EQUALIZATION SYSTEM

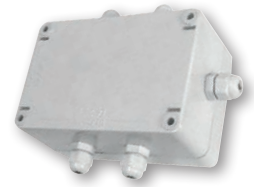

ORDER CODES

Code	Description
SG-EQ4	Equalization and connection circuit up to 4 load cell in parallel
SG-EQ4-BOXPG7	Equalization and connection circuit up to 4 load cell in parallel + IP66 box including mm diameter cable glands 7 and 2 hole covers

Z-POWER

DIN RAIL 19 VAC TRANSFORMERS



Primary Voltage: 230 (115) Vac \pm 10%

Case: Self-extinguish thermoplastic material (V-0 class)

Protection method: With thermofuse

Dimension: 3 DIN modules (15 VA version), 5 DIN modules (25 VA)

Protection degree: IP 40

ORDER CODES

Code	Description
Z-POWER 230-15VA	DIN rail 19 Vac transformers, 230-15 VA
Z-POWER 230-25VA	DIN rail 19 Vac transformers, 230-25 VA
Z-POWER 115-15VA	DIN rail 19 Vac transformers, 115-15 VA

Z-SUPPLY

Single-Phase Switching Power Supply 24V @ 1.5A



- **Input voltage range:** 110..230 Vac @ 47-63 Hz 0,7 A; 110..315 Vdc, 0,7 A
- **Output voltage:** 24 Vdc \pm 2%
- **Redundancy:** Parallel connection of 2 Z-SUPPLY by IDC10 connector
- **Output current:** 1,5 A
- **Control output:** "Power Good" relay output
- **Internal fuse:** 1,25 A type T
- **Mounting:** On DIN 46277 rail
- **Isolation:** Up to 3 KV input

ORDER CODES

Code	Description
Z-SUPPLY	Single-phase switching power supply 24V @ 1.5A

CABLES

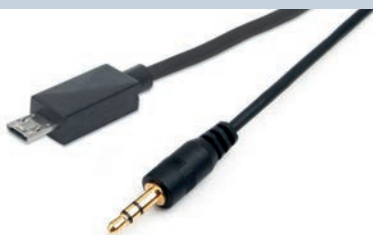

ORDER CODES

Code	Description
CS-JACK-DB9F	Programming serial cable (Jack / DB9F)
CU-A-MICROB	USB A – Micro USB-B 5P plug cable
CU-A-MICRO-OTG	Micro USB OTG – USB Type A F adapter cable

APPLICATION NOTE

Z109REG2-1

Analog signal conversion and retransmission with relay output

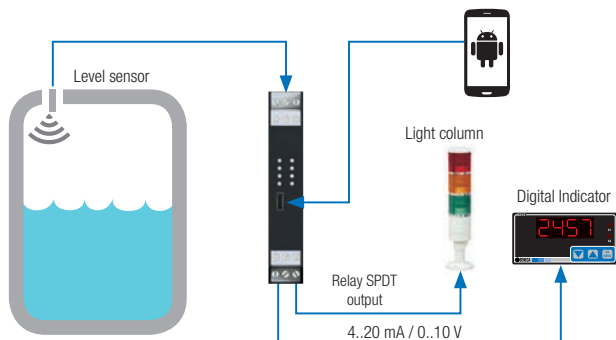

Z109REG2-1

Multiplexing and PLC signal retransmission

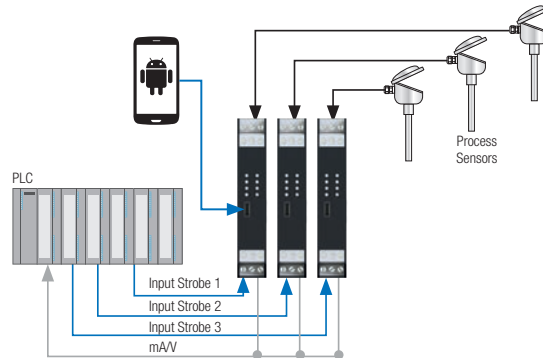

Z170REG-1

Analog signal Duplication and retransmission

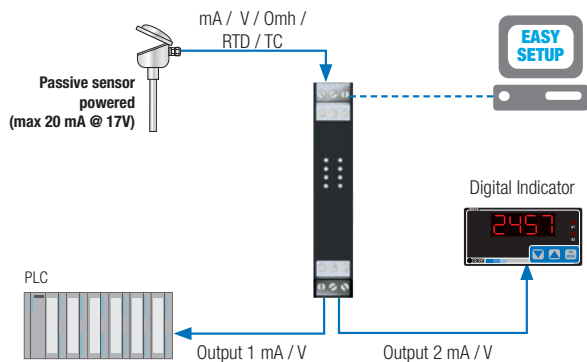

Z202

AC voltage conversion into a normalized signal mA / V

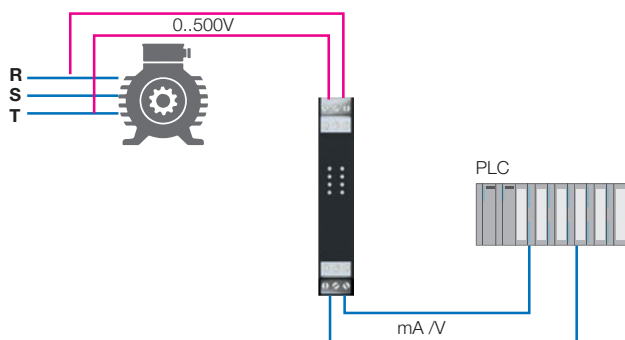

Z203-1

One phase power meter with signal output retransmission

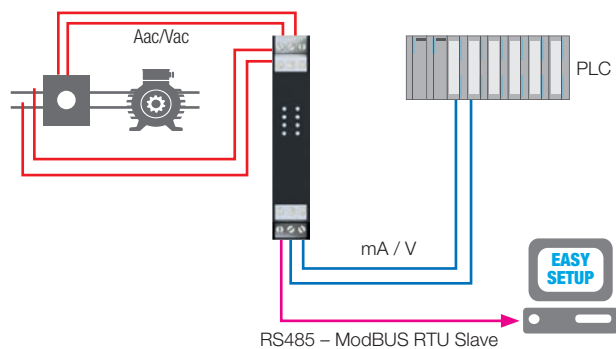

Z109PT2-1

RTD to mA/V standard output Signal temperature converter

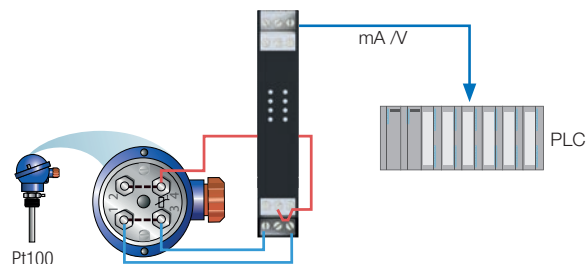

Z104

Flow meter pulse counter

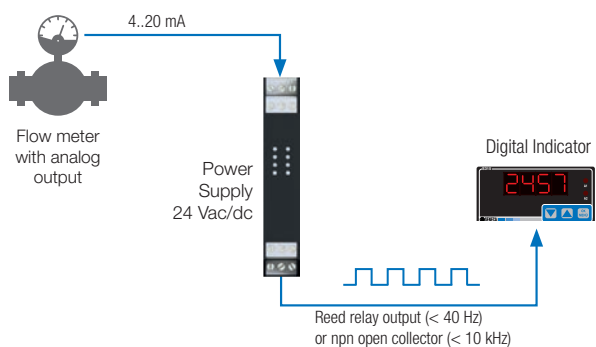

Z111

Acquisition of instantaneous flow (frequency signal)

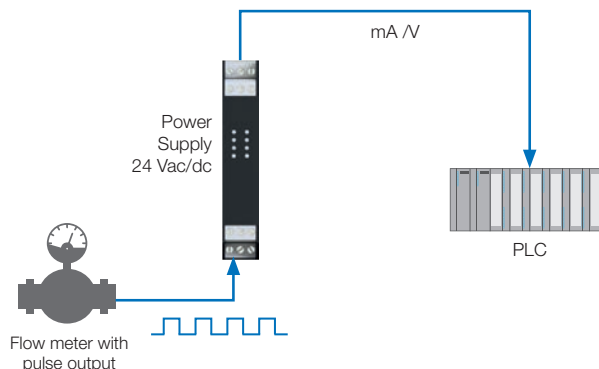

SELECTION GUIDE

INSTRUMENT CODE	CONVERSION				POWER SUPPLY					OTHER FEATURES	
	IN	OUT	NR. INPUT	NR. OUTPUT	19..40 Vdc (9..30 Vdc opz.); 19..28 Vac	10..40 Vdc; 19..28 Vac	85..265 Vac/dc	EXTERNAL / BY MEASURE LOOP	POWER TRANSDUCER (ACTIVE INPUT)	MAX ISOLATION	ACCURACY CLASS
ANALOG CONVERTERS											
Z102	Ohm	mA, V	1	1	x					1,5 kVac	0,2%
Z109REG	mA, mV, V, Ohm, TC (J,K,R,S,T,B,E,N), Pt100	mA, V	1	1	x				18 Vdc	1,5 kVac	0,2%
Z109REG2-1	mA, mV, V, Ohm, TC (J,K,R,S,T,B,E,N), Pt100, Pt500, Pt1000, Ni100, KTY81, KTY84, NTC, (Strobe)	mA, V, (Relay SPST)	2	2		x			20 Vdc	1,5 kVac	0,1%
Z109REG2-H	mA, mV, V, Ohm, TC (J,K,R,S,T,B,E,N), Pt100, Pt500, Pt1000, Ni100, KTY81, KTY84, NTC, (Strobe)	mA, V, (Relay SPST)	2	2			x		20 Vdc	1,5 kVac	0,1%
Z109REG-BP	mA, mV, V, Ohm, TC (J,K,R,S,T,B,E,N), Pt100, Pt500, Pt1000, Ni100, KTY81, KTY84, NTC	mA, V	1	1		x			17 Vdc	1,5 kVac	0,1%
Z109S	mA	mA	1	1	x				20 Vdc	1,5 kVac	0,2%
Z109S-DI	mA	mA	1	1		x			17 Vdc	3,5 kVac	0,2%
Z109UI2-1	mA, V, mV	mA, V	1	1		x				1,5 kVac	0,1%
Z110D	mA	mA	2	2				x		1,5 kVac	0,1%
Z110S	mA	mA	1	1				x		1,5 kVac	0,1%
Z170REG-1	mA, mV, V, Ohm, TC (J,K,R,S,T,B,E,N), Pt100, Ni100, Pt500, Pt1000, (Strobe)	mA, V, (Relay SPST)	1	2		x				1,5 kVac	0,1%
Z190	mA, V	mA, V	2	1	x				20 Vdc	1,5 kVac	0,2%
Z-SG	mV, Load cell	mA, V, RS485 ModBUS	1	1		x				1,5 kVac	0,01%
A/D CONVERTERS											
Z-4AI-D	mA, V	Serial / Signals 24V PNP (Clock, Data, Strobe)	4	3	x					1,5 kVac	0,1%
Z-4TC-D	TC, mV	Serial / Signals 24V PNP (Clock, Data, Strobe)	4	3	x					1,5 kVac	0,1%
ELECTRIC METER CONVERTERS											
Z201	Aac	mA, V	1	1	x					1,5 kVac	0,3%
Z201-H	Aac	mA, V	1	1			x			4 kVac	0,3%
Z202	Vac	mA, V	1	1		x				3,75 kVac	0,25%
Z202-H	Vac	mA, V	1	1			x			4 kVac	0,25%
Z202LP	Vac/dc	mA, V	1	1				x		4 kVac	0,25%
Z203-1	A, V	mA, V, RS485 ModBUS	1	1		x				3,75 kVac	0,5%
Z204-1	Vac/dc	mA, V, RS485 ModBUS	1	1		x				4 kVac	0,5%
RELAYS CONDITIONERS											
Z112A	Free contact, Reed, NPN, PNP, Namur, Photoelectric, Hall, Variable reluctance, 24V pulse, TTL, Volumetric meter	Relay SPDT	1	1	x				20 Vdc	1,5 kVac	
Z112D	Free contact, Reed, NPN, PNP, Namur, Photoelectric, Hall, Variable reluctance, 24V pulse, TTL, Volumetric meter	Relay SPST	2	2	x				20 Vdc	1,5 kVac	
Z113D	mA, V	Relay SPST	1	2	x				20 Vdc	1,5 kVac	
Z113S	mA, V	Relay SPDT	1	1	x				20 Vdc	1,5 kVac	
Z113T	mA, V	Relay SPST	1	3	x				20 Vdc	1,5 kVac	
Z113-1	mA, V, Ohm, RTD, TC	Relay SPST	1	2		x				1,5 kVac	
TEMPERATURE CONVERTERS											
Z109PT2-1	Pt100, Ni100, Pt500, Pt1000	mA, V	1	1		x				1,5 kVac	0,1%
Z109TC2-1	TC (J,K,R,S,T,B,E,N)	mA, V	1	1		x				1,5 kVac	0,2%
PULSE CONVERTERS											
Z104	mA, V	NPN Open Collector, Reed Relay	1	1	x				20 Vdc	1,5 kVac	0,2%
Z111	Free contact, Reed, NPN, Namur, Photoelectric, Hall, Variable reluctance, 24V pulse, TTL, Volumetric meter	mA, V	1	1	x				20 Vdc	1,5 kVac	0,2%

INSTANT SETTING THROUGH MOBILE APP FOR ANDROID



EASY Setup APP provides the same functionality of EASY Setup available for Windows PC with an intuitive and user friendly interface for: operating parameters and communication setting and changing, individual modules automatic configuration, real-time test configuration and fast replication of the settings for multiple installations.

Easy to download and provided with simple and intuitive interface, EASY Setup app allows direct connection to SENECA programmable device for immediate monitoring, programming and testing operations of single devices.

Supported modules: Z109REG2-1, Z109UI2-1, Z109REG-BP, Z170REG-1, Z109PT2-1, Z109TC2-1

Language: Italian, English

Android versions: 4.0 and later

Mobile terminals: Android Smartphone/Tablet with OTG function

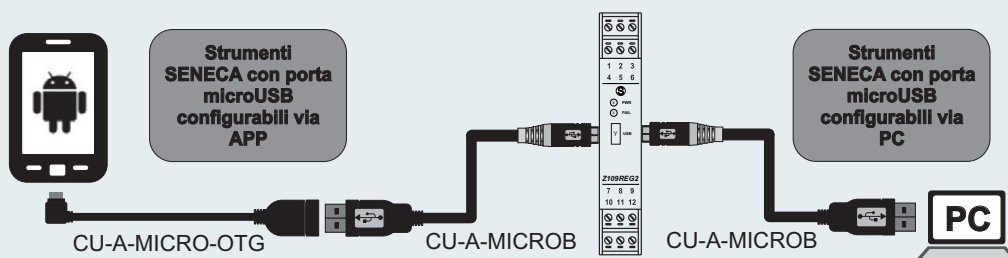
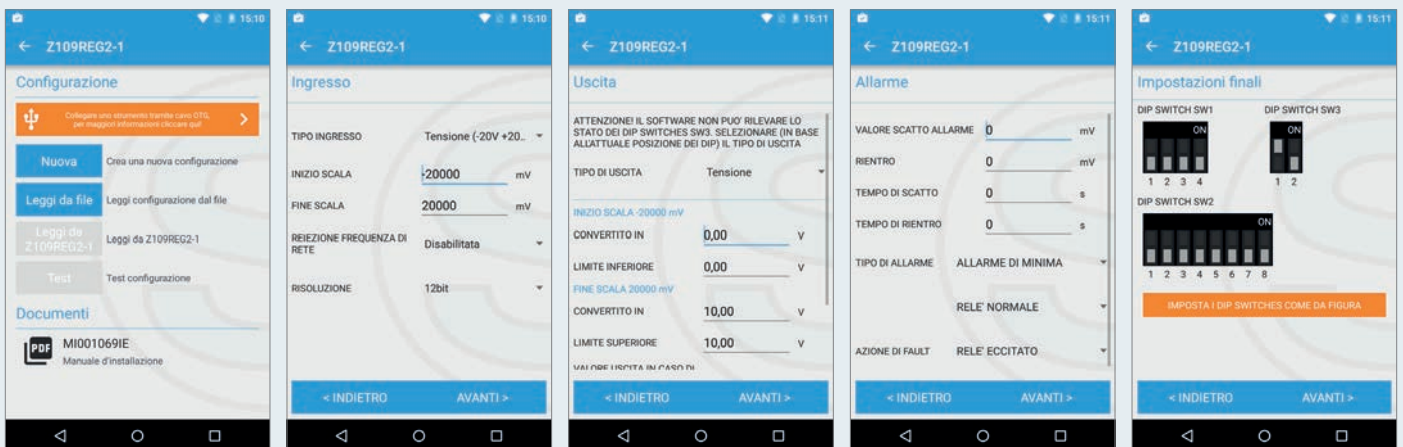

CONTACT AND INFORMATION

Address

Headquarter: Via Austria 26 - 35127 Padova (I)
Tel. +39 049 8705 359 (408)
Fax +39 049 8706287

Web

Automation Products: www.seneca.it
Tech Support: www.seneca.it/supporto

E-mail

General information: info@seneca.it
Sales Office: sales@seneca.it
Quality Management: qualita@seneca.it
Product technical support: support@seneca.it

Follow us on Social Media

