





INSTALLATION MANUAL

R-8AI-8DIDO R-8AI-8DIDO-P

PRELIMINARY WARNINGS

The word **WARNING** preceded by the symbol  indicates conditions or actions that put the user's safety at risk. The word **ATTENTION** preceded by the symbol  indicates conditions or actions that could damage the instrument or connected equipment.

The warranty shall become null and void in the event of improper use or tampering with the module or devices supplied by the manufacturer as necessary for its correct operation, and if the instructions contained in this manual are not followed.

	WARNING: The full content of this manual must be read before any operation. The module must only be used by qualified electricians. Specific documentation is available using the QR-CODE shown on page 1.
	The module must be repaired and damaged parts replaced by the Manufacturer. The product is sensitive to electrostatic discharges. Take appropriate measures during any operation.
	Electrical and electronic waste disposal (applicable in the European Union and other countries with recycling). The symbol on the product or its packaging shows the product must be surrendered to a collection centre authorized to recycle electrical and electronic waste.



R-8AI-8DIDO
DOCUMENTATION



SENECA s.r.l.; Via Austria, 26 – 35127 – PADOVA – ITALY; Tel. +39.049.8705359 - Fax +39.049.8706287

CONTACT INFORMATION

Technical support	supporto@seneca.it	Product information	commerciale@seneca.it
-------------------	--------------------	---------------------	-----------------------

This document is the property of SENECA srl. Copies and reproduction are prohibited unless authorised.

The content of this document corresponds to the described products and technologies.

Stated data may be modified or supplemented for technical and/or sales purposes.

MODULE LAYOUT

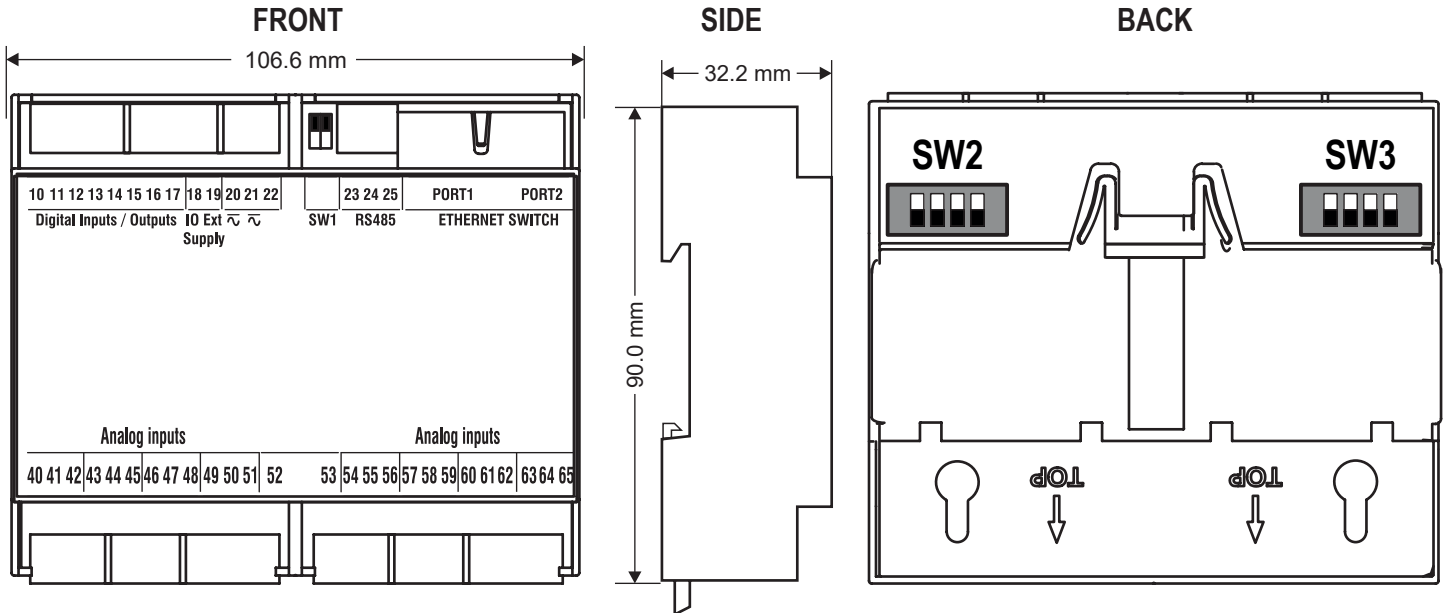



Weight: 170 g; **Enclosure:** UL94-V0 self-extinguishing PC/ABS material, black.

SIGNALS VIA LED ON FRONT PANEL

LED	STATUS	LED meaning
IO1/IO8	On	Digital input/output active
	Off	Digital input/output not active
OUT SUP	On	Digital inputs/outputs powered
	Off	Digital inputs/outputs not powered
STS (Status only version R-8AI-8DIDO)	On	IP address set
	Flashing	Waiting for the IP address from the DHCP
STS (Status only version R-8AI-8DIDO-P)	On	IP address set
	Flashing	No configured IP address
COM (only version R-8AI-8DIDO-P)	Off	No Profinet communication
	Flashing	Profinet communication present
FAIL	On	Digital output in FAIL / TC in Burn or out of range
RX (only version R-8AI-8DIDO)	On	RS485 port wiring error
	Flashing	Reception of data packet completed on RS485
TX (only version R-8AI-8DIDO)	Flashing	Reception of data packet completed on RS485
ETH TRF (Yellow)	Flashing	Packet transit on Ethernet port
ETH LNK (Green)	Flashing	Ethernet port connected

TECHNICAL SPECIFICATIONS

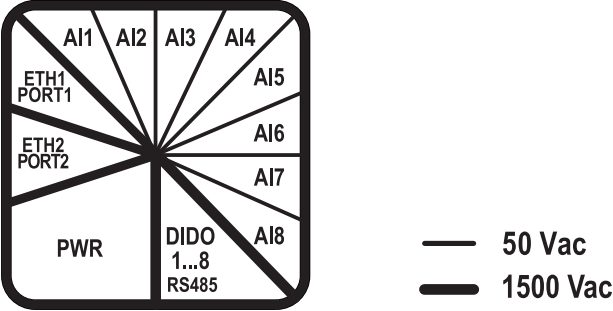
CERTIFICATIONS	  
INSULATION	
POWER SUPPLY	Voltage: 10 ÷ 40 Vdc; 19 ÷ 28 Vac; 50 ÷ 65 Hz; Absorption: 3 W
ENVIRONMENTAL CONDITIONS	Operating temperature: from -25°C to +65°C Humidity: 10% ÷ 90% non condensing. Storage temperature: from -30°C to +85°C Protection rating: IP20
ASSEMBLY	35mm DIN rail IEC EN60715
CONFIGURATION	With built-in WEB server (only version R-8AI-8DIDO)
CONNECTIONS / COMMUNICATION PORTS	3.5 mm pitch terminal block, 1.5 mm ² max cable section 2 Ethernet (with LAN fault-bypass function) 100 base T on RJ45 1 RS485 port on terminals (only version R8AI--8DIDO)
DIGITAL INPUTS	Number of channels: 8; Voltage: Threshold ON: > 11 V; Threshold OFF:< 4 V; Vmax: 28 V; Impedance 9 kΩ Compliant with IEC61131-2 type 3.
DIGITAL OUTPUTS	Number of channels: 8, MOSFET, PNP; Max voltage/current: 0.2A; 9÷ 28 V
ANALOG INPUT	Number of channels: 8; Type: voltage, current, thermocouple, Max. 1 PT100 resistance thermometer. Measuring range: Voltage: -30 V ÷ +30 V; -150 mV ÷ +150 mV Current: -24 mA ÷ +24 mA (maximum loop power: 24 Vdc) Thermocouple: J, K, T, E, N, R, S, B, L Resistance thermometer: PT100: -200 °C ÷ +650 °C (only for cold junction or measurement compensation)

ELECTRICAL CONNECTIONS

⚠ CAUTION

The upper power supply limits must not be exceeded, as this could cause serious damage to the module.

Switch the module off before connecting inputs and outputs.

To meet the electromagnetic immunity requirements:

- use shielded signal cables;
- connect the shield to a preferential instrumentation earth system;
- separate shielded cables from other cables used for power installations (transformers, inverters, motors, etc...).

POWER SUPPLY

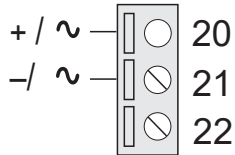

RS485 SERIAL PORT

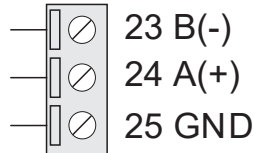

Connection to the RS485 port.
Polarity is not standardised and in some devices may be inverted.

CURRENT (mA)

Passive transmitter, with external power supply (SINK)

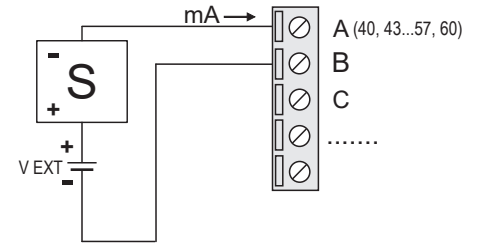

The relative dip-switch goes to the ON position

ANALOG INPUTS: The device has 8 analog inputs that can be configured via DIP-SWITCH:

CURRENT (mA)

Active transmitter (SOURCE)

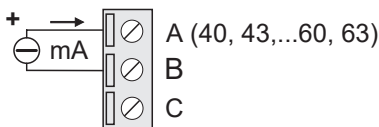

The relative dip-switch goes to the ON position

VOLTAGE (V)

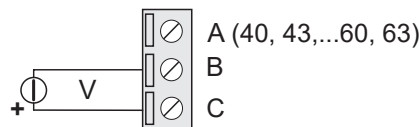

The relative dip-switch goes to the OFF position

THERMOCOUPLE (Tc / mV)

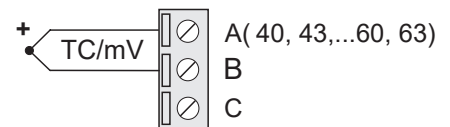

The relative dip-switch goes to the OFF position

DIGITAL INPUTS (PNP)

With external power

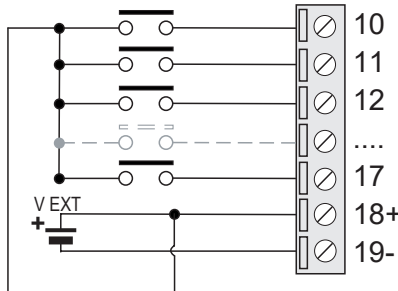

Digital inputs must be externally powered to function properly.

DIGITAL OUTPUTS (PNP)

With external power

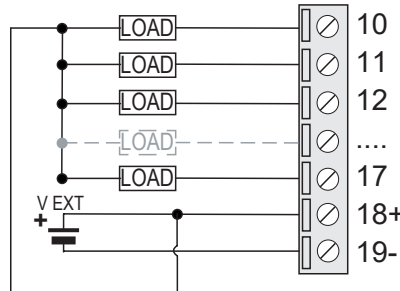

The digital outputs must be powered externally to function properly.

SETTING THE DIP-SWITCHES

⚠ WARNING

The DIP-switch settings are read only at boot time. At each change, perform a restart.

For use and settings via DIP-SWITCH, see the user manual available on the website on the web page dedicated to the product.

DIP-SWITCH SW2 AND SW3: ANALOG INPUT CONFIGURATION

SW2				SW3			
1	2	3	4	1	2	3	4
AI1	AI2	AI3	AI4	AI5	AI6	AI7	AI8

DIP-SWITCHES SW2 and SW3 are located on the back of the device.

SW1 DIP-SWITCH: DEFAULT SETTINGS

SW1		
DIP1	OFF	DEFAULT SETTINGS
DIP2	OFF	

DIP-SWITCH SW1 is located on the front of the device.

⚠ CAUTION

The input for the RTD thermoresistance is available only for the first channel. For channels 2 to 8 it is not available.

⚠ WARNING

The product is not suitable for connection to a dangerous voltage conductor.
The maximum allowable voltage is 50 Vac / 75 Vdc with respect to earth.

THERMORESISTANCE

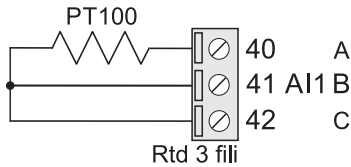

The SW1 Dip-Switch selector 1 goes to the OFF position.
Function valid only for analog input 1.

INSTRUCTIONS FOR ANALOG INPUTS:

The analog inputs of this device are designed to measure voltages/currents on floating circuits that is not electrically connected to each other.

In the case of measurement with thermocouples it is possible to obtain correct measurements even if they are applied to common metal parts.

The temperature measurement using thermocouples can be affected by measurement errors due to the determination of the cold junction temperature carried out near the terminal. To eliminate any measurement errors it is necessary to wire the thermocouples on an isothermal terminal board separate from the device as shown in the diagram on the side.

Input No.1 set as Pt100 (see the DIP- SWITCH table) will then be used to measure the cold junction temperature of said terminal block.

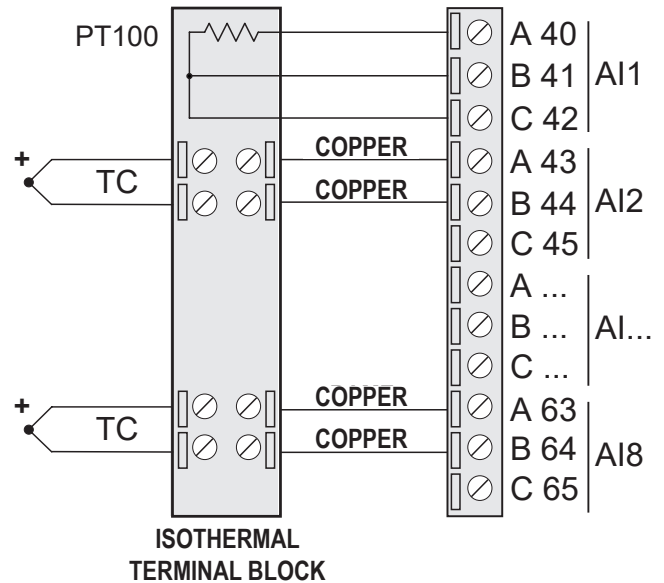

FEATURE SUMMARY

ANALOG INPUTS

	Range	Effective resolution (at 400 ms)	Impedance	Precision	Temperature drift	Ext. current
Voltage (V)	-30 ÷ +30 Vdc	0.05 mV	> 200 kΩ	0.1% f.s.	50 ppm	
Current (mA)	0 ÷ +24 mA	0.07 μA	60 Ω	0.1% f.s.	50 ppm	
Voltage (mV)	-150 ÷ +150 mV	0.5μV	> 10 MΩ	0.1% f.s.	50 ppm	
Thermocouple	-150 ÷ +150mV	0.5μV	> 10 MΩ	0.1% f.s.	50 ppm	
PT100	-200 ÷ 650 °C	6 mΩ (0.015°C at 0°C)		0.1°C	50 ppm	250 μA

THERMOCOUPLE TYPE

	Range [°C]	Standard	Internal cold junction error [°C]
J	-210..1200	EN 60584	2
K	-200..1372	EN 60584	2
T	-200..400	EN 60584	2
E	-200..1000	EN 60584	2
N	-200..1300	EN 60584	2
R	-50..1768	EN 60584	2
S	-50..1768	EN 60584	2
B	250..1820	EN 60584	2
L	-200..800	GOST:8.585	2

DAISY-CHAIN ETHERNET CONNECTION

⚠ WARNING

FUNCTION VALID ONLY FOR THE R-8AI/8DIDO-2 AND R-8AI-8DIDO-2-P MODELS

⚠ CAUTION

IT IS NOT ALLOWED TO CREATE LOOPS WITH ETHERNET CABLES

Using the daisy-chain connection it is not necessary to use switches to connect the devices.

The following examples show the correct connections.

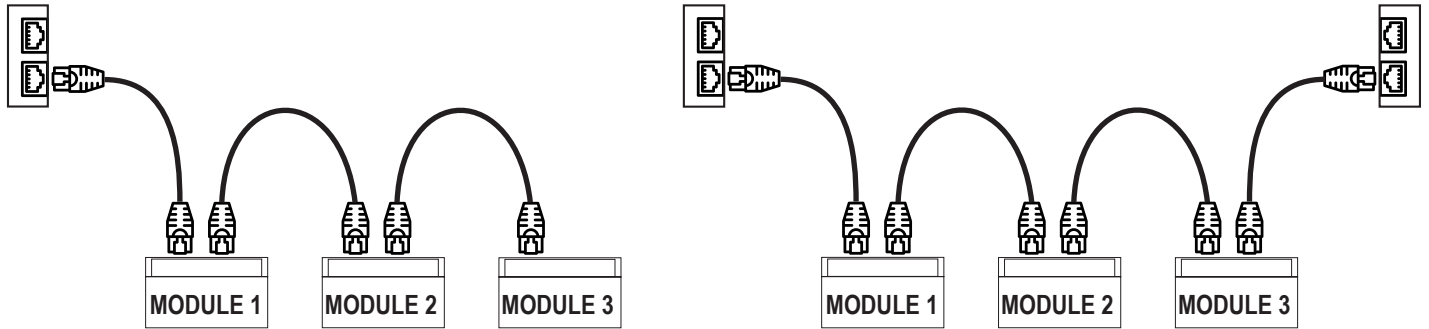

There must be no loops in the Ethernet cabling, otherwise the communication will not work. The modules and switches must be connected eliminating any loops. The following examples show the incorrect connections.

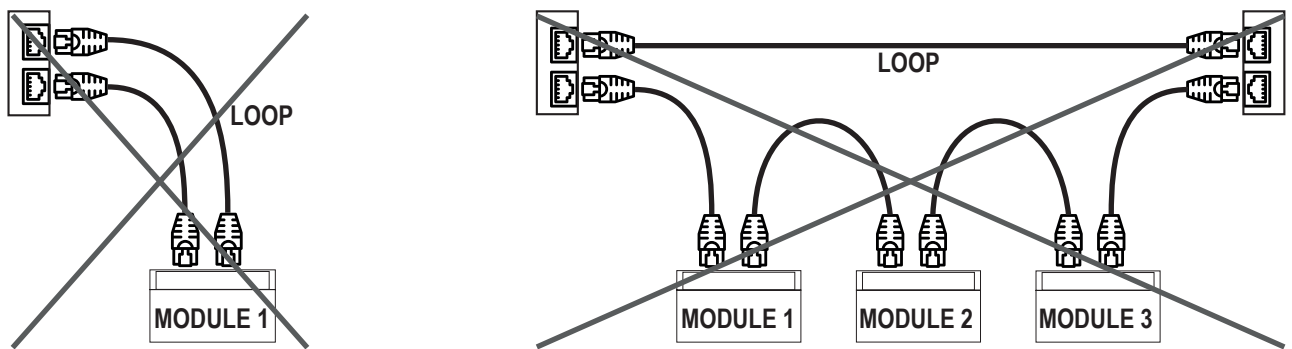

The LAN fault-bypass function allows you to keep the connection between the two Ethernet ports of the device ON, in the event of a power failure. If a device turns off, the chain is not interrupted and the devices downstream of the switched-off one will still be accessible. This function has a limited duration: the connection remains active for a few days, typically 4. The fault-bypass function requires that the sum of the lengths of the two cables connected to the switched off module is less than 100m.

ETHERNET CONNECTION RULES

For the Ethernet cabling between the devices, the use of the unshielded CAT5 or CAT5e cable is required.

FACTORY IP ADDRESS (ONLY R-8AI-8DIDO)

The default module IP address is static: 192. 168. 90. 101

WEB SERVER

To access the maintenance Web Server, use the following credentials:

Default user: admin

Default password: admin

⚠ CAUTION

DO NOT USE DEVICES WITH THE SAME IP ADDRESS IN THE SAME ETHERNET NETWORK.