

MANUALE UTENTE

Serie R203 / R203-P / R203-E



SENECA S.r.l.

Via Austria 26 – 35127 – Z.I. - PADOVA (PD) - ITALY
Tel. +39.049.8705355 – 8705355 Fax +39 049.8706287

www.seneca.it



ORIGINAL INSTRUCTIONS

Il contenuto della presente documentazione si riferisce a prodotti e tecnologie descritti in esso.

Tutti i dati tecnici contenuti nel documento possono essere modificati senza preavviso.

Il contenuto di questa documentazione è soggetto a revisione periodica.

Per utilizzare il prodotto in modo sicuro ed efficace, leggere attentamente le seguenti istruzioni prima dell'uso.

Il prodotto deve essere utilizzato solo per l'uso per cui è stato progettato e realizzato: qualsiasi altro uso è sotto piena responsabilità dell'utente.

L'installazione, la programmazione e il set-up sono consentiti solo agli operatori autorizzati, fisicamente e intellettualmente adatti.

Il set-up deve essere eseguito solo dopo una corretta installazione e l'utente deve seguire tutte le operazioni descritte nel manuale di installazione con attenzione.

Seneca non è responsabile per guasti, rotture e incidenti causati dall'ignoranza o dalla mancata applicazione dei requisiti indicati.

Seneca non è considerata responsabile per eventuali modifiche non autorizzate.

Seneca si riserva il diritto di modificare il dispositivo, per qualsiasi esigenza commerciale o di costruzione, senza l'obbligo di aggiornare tempestivamente i manuali di riferimento.

Nessuna responsabilità per il contenuto di questo documento può essere accettata.

Utilizzare i concetti, gli esempi e altri contenuti a proprio rischio.

Potrebbero esserci errori e imprecisioni in questo documento che potrebbero danneggiare il tuo sistema, procedere quindi con cautela, l'autore(i) non se ne assumono la responsabilità.

Le caratteristiche tecniche sono soggette a modifiche senza preavviso.

CONTACT US

Technical support	supporto@seneca.it
Product information	commerciale@seneca.it

Questo documento è di proprietà di SENECA srl.
La duplicazione e la riproduzione sono vietate, se non autorizzate

Document revisions

DATE	REVISION	NOTES	AUTHOR
23/06/2023	0	First revision	MM
26/06/2023	1	Changed power supply value for R203-L version	AZ
02/10/2023	2	Added table of Rogowski sensor input full scale	AZ
03/11/2023	3	Added -P model Deleted models -1	MM
21/11/2023	4	Supported new firmwares: R203 rev 1030 R203-P rev 1024 For Aron insertion support	MM
01/12/2023	5	Added Dip Switch chapter	MM
05/12/2023	6	Fix Dip Switch name	AZ
07/12/2023	7	Added info on Datalogger and Smart Functions	MM
09/01/2023	8	Added new placeholders for Smart Functions from firmware 1035 %tms and %i	MM
19/02/2024	9	Fix Dip switch table in "Dip Switch" chapter	MM
22/03/2024	10	Added Modbus registers refresh time (Chapter 6.5)	MM
04/04/2023	11	Added new R203-E product	MM

INDICE

1. AVVERTENZE	8
2. INTRODUZIONE	9
3. MODELLI SERIE R203	9
4. DIP SWITCH	10
5. MISURE DISPONIBILI DA ETHERNET/SERIALE	11
5.1. CONVENZIONI	11
5.2. VALORI ISTANTANEI	12
5.3. VALORI MEDI (NEL DEMAND TIME CONFIGURATO)	12
5.4. VALORI MASSIMI / MINIMI ASSOLUTI	13
5.5. CONTATORI	13
5.6. ANALISI ARMONICA FINO ALLA 55 ESIMA (SOLO MODELLO R203)	14
6. TEMPI DI MISURA E CALCOLO	15
6.1. TEMPI DI CAMPIONAMENTO	15
6.2. TEMPI DI ASSESTAMENTO PER I VALORI RMS	15
6.3. TEMPI DI RISPOSTA DELL'USCITA ANALOGICA	15
6.4. TEMPI DI AGGIORNAMENTO DEI REGISTRI RELATIVI ALL'ANALISI ARMONICA (SOLO MODELLI R203)	15
6.5. TEMPI DI AGGIORNAMENTO DEI REGISTRI MODBUS (SOLO MODELLI R203)	15
7. PRECISIONI DELLE MISURE A 23°C	16

8. FONDO SCALA DEGLI INGRESSI PER SENSORI ROGOWSKI	16
9. DATALOGGER (SOLO MODELLI R203).....	17
9.1. DATALOGGER DATI A TEMPO	17
9.2. DATALOGGER DEGLI EVENTI.....	17
10. FUNZIONI SMART PER L'INVIO DEI DATI E DEGLI EVENTI AI CLOUD (SOLO MODELLI R203).....	18
10.1. PROTOCOLLO MQTT(S) CLIENT.....	18
10.2. PROTOCOLLO HTTP(S) POST.....	18
10.3. PROTOCOLLO FTP CLIENT.....	18
10.4. INVIO DEI DATI ED EVENTI CON O SENZA RECUPERO.....	19
11. CONNESSIONE DEI DISPOSITIVI AD UNA RETE	20
11.1. MODELLI R203 / R203-E.....	20
11.2. MODELLI R203-P	21
12. COPIA I/O TRAMITE LA FUNZIONE PEER TO PEER SENZA CABLAGGI (SOLO MODELLI R203).....	21
13. WEBSERVER	23
13.1. ACCESSO AL WEBSERVER	23
14. DIAGNOSTICA DI CONNESSIONE	24
15. CONFIGURAZIONE DEL DISPOSITIVO TRAMITE WEBSERVER (SOLO MODELLI R203 / R203-E).....	25
15.1. SEZIONE COMMUNICATION SETUP	25
15.2. SEZIONE MEASURES SETUP	27

15.3.	SEZIONE SETUP ANALOG AND DIGITAL OUTPUT	28
15.4.	SEZIONE SETUP DIGITAL INPUT	29
15.5.	SEZIONE SETUP DATALOGGER (SOLO MODELLI R203).....	29
15.6.	SEZIONE SETUP FTP (SOLO MODELLI R203)	30
15.7.	SEZIONE CONNECTIONS DIAGNOSTIC	31
15.8.	SEZIONE MQTT CONFIGURATION (SOLO MODELLI R203).....	31
15.8.1.	ESEMPI:.....	41
15.9.	SEZIONE HTTP CONFIGURATION (SOLO MODELLI R203)	45
16.	DOWNLOAD DEI FILE DEL DATALOGGER (SOLO MODELLI R203)	53
17.	MODBUS PASSTHROUGH (SOLO MODELLI R203)	53
18.	AGGIORNAMENTO DEL FIRMWARE.....	54
19.	PROTOCOLLO DI COMUNICAZIONE MODBUS (SOLO MODELLI R203).....	54
19.1.	CODICI FUNZIONE MODBUS SUPPORTATI.....	54
19.2.	TAVOLA DEI REGISTRI MODBUS	55
19.3.	NUMERAZIONE DEGLI INDIRIZZI MODBUS “0 BASED” O “1 BASED”	55
19.4.	NUMERAZIONE DEGLI INDIRIZZI MODBUS CON CONVENZIONE “0 BASED” 56	
19.5.	NUMERAZIONE DEGLI INDIRIZZI MODBUS CON CONVENZIONE “1 BASED” (STANDARD)	56
19.6.	CONVENZIONE DEI BIT ALL’INTERNO DI UN REGISTRO MODBUS HOLDING REGISTER	57

19.7. CONVENZIONE DEI BYTE MSB E LSB ALL'INTERNO DI UN REGISTRO MODBUS HOLDING REGISTER	57
19.8. RAPPRESENTAZIONE DI UN VALORE A 32 BIT IN DUE REGISTRI MODBUS HOLDING REGISTER CONSECUTIVI.....	58
19.9. TIPI DI DATO FLOATING POINT A 32 BIT (IEEE 754)	58
19.10. TAVOLA DEI REGISTRI MODBUS 4X HOLDING REGISTERS (FUNCTION CODE 3) 60	
20. PROTOCOLLO DI COMUNICAZIONE PROFINET IO (SOLO MODELLI R203-P) .	148
20.1. CREAZIONE DI UN PROGETTO CON PLC SIEMENS (TIA PORTAL 16) (SOLO MODELLI R203-P)	148
20.1.1. INSTALLAZIONE DEL FILE GSDML	149
20.1.2. INSERIMENTO DEL PLC SIEMENS NEL PROGETTO	150
20.1.3. INSERIMENTO DELL'IO PROFINET SENECA.....	153
20.1.4. CONFIGURAZIONE DEI PARAMETRI DEL DISPOSITIVO SENECA	157
20.1.5. PARAMETRI DI CONFIGURAZIONE DEL FILE GSDML	158
20.1.6. DATI I/O R203-P	159
21. PROTOCOLLO DI COMUNICAZIONE ETHERNET/IP (SOLO MODELLI R203-E).	171
21.1. CREAZIONE DI UN PROGETTO CON PLC ALLEN BRADLEY/ROCKWELL (RS-LOGIX5000 / STUDIO 5000 LOGIX DESIGNER 35.00.00)	171

1. AVVERTENZE

 **ATTENZIONE!**

Questo manuale utente estende le informazioni dal manuale di installazione sulla configurazione del dispositivo. Utilizzare il manuale di installazione per maggiori informazioni.

 **ATTENZIONE!**

In ogni caso, SENECA s.r.l. o i suoi fornitori non saranno responsabili per la perdita di dati / incassi o per danni consequenziali o incidentali dovuti a negligenza o cattiva/impropria gestione del dispositivo, anche se SENECA è ben consapevole di questi possibili danni.

SENECA, le sue consociate, affiliate, società del gruppo, i suoi fornitori e rivenditori non garantiscono che le funzioni soddisfino pienamente le aspettative del cliente o che il dispositivo, il firmware e il software non debbano avere errori o funzionare continuativamente.

2. INTRODUZIONE

Gli smart energy meter trifase della serie R203 permettono la misura e il calcolo di grandezze elettriche quali tensione, corrente, potenza, energia, armoniche etc...

I dispositivi sono dotati di un ingresso in corrente universale (TA con uscita in corrente, TA con uscita in tensione, sensori Rogowski) e supportano i tipi di inserzione monofase e trifase a 3 o 4 fili.

Le misure e i calcoli sono resi disponibili tramite protocolli di comunicazione disponibili in base al modello.

In alcuni modelli è anche possibile attivare il datalogger ed inviare i dati ai cloud tramite i protocolli MQTT(s), HTTP(s) o FTP.

3. MODELLI SERIE R203

I modelli della serie R203 sono rappresentati in tabella:

MODELLO	NUMERO DI PORTE ETHERNET	ALIMENTAZIONE	PROTOCOLLI DI COMUNICAZIONE	DATALOGGER	INVIO DATI SU CLOUD (FUNZIONI SMART)
R203-2-L	2	10 ÷ 30Vdc	MODBUS TCP-IP MODBUS RTU MQTT(s) HTTP(s) FTP	SI'	SI'
R203-2-H	2	90 ÷ 264Vac	MODBUS TCP-IP MODBUS RTU MQTT(s) HTTP(s) FTP	SI'	SI'
R203-2-L-P	2	10 ÷ 30Vdc	PROFINET IO	NO	NO
R203-2-H-P	2	90 ÷ 264Vac	PROFINET IO	NO	NO
R203-2-L-E	2	10 ÷ 30Vdc	ETHERNET/IP	NO	NO
R203-2-H-E	2	90 ÷ 264Vac	ETHERNET/IP	NO	NO

4. DIP SWITCH

I Dispositivi sono dotati di 2 dip switch.

La posizione dei dip switch è rappresentata in figura:



Qui sotto è riportato il significato dei dip switch SW1:

DIP1	DIP2	SIGNIFICATO
OFF	OFF	Funzionamento Normale: Il dispositivo carica la configurazione dalla flash.
ON	ON	Porta il dispositivo alla configurazione di fabbrica
OFF	ON	Disabilita l'accesso al Web server
ON	OFF	Forza l'indirizzo IP a 192.168.90.101

5. MISURE DISPONIBILI DA ETHERNET/SERIALE

5.1. CONVENZIONI

Il dispositivo fornisce i valori di misura su tutti e 4 i quadranti, le convenzioni per i segni delle misure utilizzate nel prodotto sono riassunte nella seguente immagine:

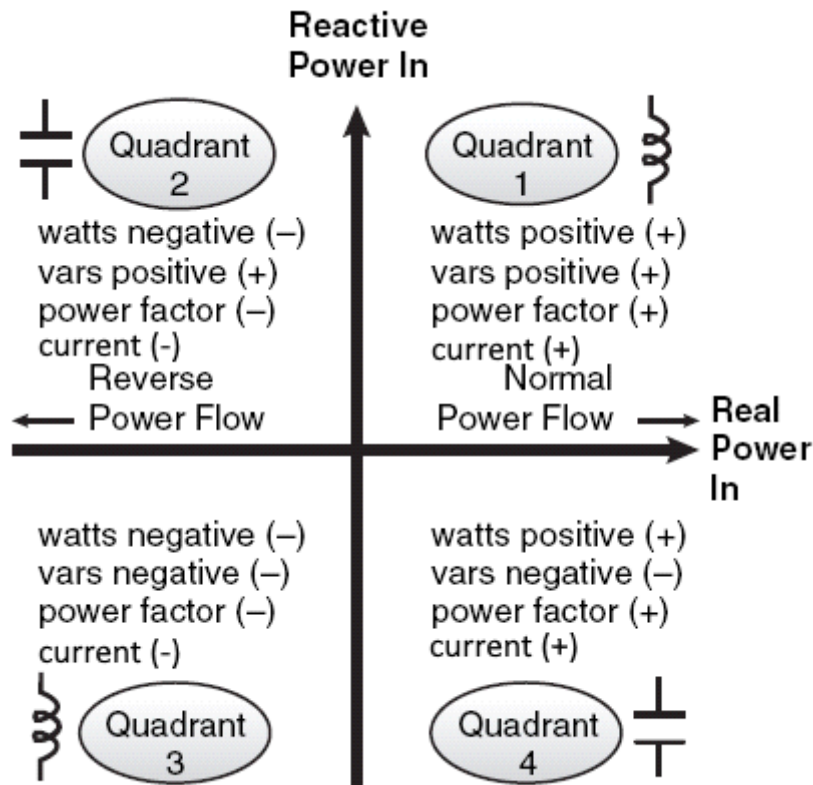

Dove:

il quadrante Q1 è relativo ad un carico induttivo con energia attiva importata (assorbita) caso classico di utilizzo.

il quadrante Q2 è relativo ad un carico capacitivo con energia attiva esportata (generata).

il quadrante Q3 è relativo ad un carico induttivo con energia attiva esportata (generata).

il quadrante Q4 è relativo ad un carico capacitivo con energia attiva importata (assorbita).

5.2. VALORI ISTANTANEI

Tensione	VL1-L2, VL2-L3, VL3-L1, VL1-N, VL2-N, VL3-N
Corrente (+/-)	IL1, IL2, IL3, IN
Potenza Attiva (+/-)	P1, P2, P3, Ptot
Potenza Reattiva (+/-)	Q1, Q2, Q3 e Qtot
Potenza Apparente	S1, S2, S3 e Stot
Fattore di Potenza (induttivo e capacitivo)	PF1, PF2, PF3 e PFtot
Frequenza	F1, F2, F3
Periodo	PER1, PER2, PER3
Sfasamento Tensione-Corrente [°]	Delta VIL1, VIL2, VIL3
Sfasamento Tensione di Linea [°]	Delta VL1-L2, VL2-L3, VL3-L1
Distorsione Armonica Totale di Tensione (THD)	THD % VL1-N, VL2-N, VL3-N
Distorsione Armonica Totale di Corrente (THD)	THD % IL1, IL2, IL3
Tensione di sistema	$V_{sys} = (VL1+VL2+VL3)/3$
Corrente di sistema	$I_{sys} = (IL1+IL2+IL3)/3$
Stato degli ingressi/uscite digitali	-
Contatore ingressi 1 e 2	Count1, Count2

5.3. VALORI MEDI (NEL DEMAND TIME CONFIGURATO)

Tensione Media	VL1-N, VL2-N, VL3-N, VL1-N MINIMO, VL1-N MASSIMO, VL2-N MINIMO, VL2-N MASSIMO, VL3-N MINIMO, VL3-N MASSIMO
Corrente Media (+/-)	IL1, IL2, IL3, IL1 MINIMO, IL1 MASSIMO, IL2 MINIMO, IL2 MASSIMO, IL3 MINIMO, IL3 MASSIMO
Potenza Attiva Media (+/-)	P1, P2, P3, P1 MINIMO, P1 MASSIMO, P2 MINIMO, P2 MASSIMO, P3 MINIMO, P3 MASSIMO, Ptot
Potenza Reattiva Media (+/-)	Q1, Q2, Q3, Q1 MINIMO, Q1 MASSIMO, Q2 MINIMO, Q2 MASSIMO, Q3 MINIMO, Q3 MASSIMO, Qtot
Potenza Apparente Media	S1, S2, S3, S1 MINIMO, S1 MASSIMO, S2 MINIMO, S2 MASSIMO, S3 MINIMO, S3 MASSIMO, Stot
Fattore di Potenza Medio (induttivo e capacitivo)	PF1, PF2, PF3, PF1 MINIMO, PF1 MASSIMO, PF2 MINIMO, PF2 MASSIMO, PF3 MINIMO, PF3 MASSIMO, PFtot
Tensione di sistema Media	VSYS, VSYS MINIMO, VSYS MASSIMO
Corrente di sistema Media	ISYS, ISYS MINIMA, ISYS MASSIMA

5.4. VALORI MASSIMI / MINIMI ASSOLUTI

Tensione	VL1-N MINIMO, VL1-N MASSIMO, VL2-N MINIMO, VL2-N MASSIMO, VL3-N MINIMO, VL3-N MASSIMO
Corrente (+/-)	IL1 MINIMO, IL1 MASSIMO, IL2 MINIMO, IL2 MASSIMO, IL3 MINIMO, IL3 MASSIMO
Potenza Attiva (+/-)	P1 MINIMO, P1 MASSIMO, P2 MINIMO, P2 MASSIMO, P3 MINIMO, P3 MASSIMO, Ptot
Potenza Reattiva (+/-)	Q1 MINIMO, Q1 MASSIMO, Q2 MINIMO, Q2 MASSIMO, Q3 MINIMO, Q3 MASSIMO, Qtot
Potenza Apparente	S1 MINIMO, S1 MASSIMO, S2 MINIMO, S2 MASSIMO, S3 MINIMO, S3 MASSIMO, Stot
Fattore di Potenza (induttivo e capacitivo)	PF1 MINIMO, PF1 MASSIMO, PF2 MINIMO, PF2 MASSIMO, PF3 MINIMO, PF3 MASSIMO, PFtot
Tensione di sistema Media	VSYS, VSYS MINIMO, VSYS MASSIMO
Corrente di sistema Media	ISYS, ISYS MINIMA, ISYS MASSIMA

5.5. CONTATORI

Tutti i contatori sono salvati in memoria non volatile.

ACTIVE ENERGY [Wh]	ACTIVE ENERGY L1 (+) Q1/Q4 ACTIVE ENERGY L2 (+) Q1/Q4 ACTIVE ENERGY L3 (+) Q1/Q4 ACTIVE ENERGY L1 (-) Q2/Q3 ACTIVE ENERGY L2 (-) Q2/Q3 ACTIVE ENERGY L3 (-) Q2/Q3 TOT ACTIVE ENERGY (+) Q1/Q4 TOT ACTIVE ENERGY (-) Q2/Q3 TOTAL ACTIVE ENERGY BALANCE (+/-)
REACTIVE ENERGY [VARh]	REACTIVE ENERGY L1 (+) Q1/Q2 REACTIVE ENERGY L2 (+) Q1/Q2 REACTIVE ENERGY L3 (+) Q1/Q2 REACTIVE ENERGY L1 (-) Q3/Q4 REACTIVE ENERGY L2 (-) Q3/Q4 REACTIVE ENERGY L3 (-) Q3/Q4 REACTIVE ENERGY L1 (+) Q1 REACTIVE ENERGY L2 (+) Q1 REACTIVE ENERGY L3 (+) Q1

	REACTIVE ENERGY L1 (+) Q2 REACTIVE ENERGY L2 (+) Q2 REACTIVE ENERGY L3 (+) Q2 REACTIVE ENERGY L1 (-) Q3 REACTIVE ENERGY L2 (-) Q3 REACTIVE ENERGY L3 (-) Q3 REACTIVE ENERGY L1 (-) Q4 REACTIVE ENERGY L2 (-) Q4 REACTIVE ENERGY L3 (-) Q4 TOT REACTIVE ENERGY (+) Q1/Q2 TOT REACTIVE ENERGY (-) Q3/Q4 TOTAL REACTIVE ENERGY BALANCE (+-)
APPARENT ENERGY [VAh]	APPARENT ENERGY L1 APPARENT ENERGY L2 APPARENT ENERGY L3 TOTAL APPARENT ENERGY
DIGITAL COUNTER INPUT 1 AND INPUT 2	32 BIT COUNTERS MAXIMUM FREQUENCY 500 Hz

5.6. ANALISI ARMONICA FINO ALLA 55 ESIMA (SOLO MODELLO R203)

ARMONICHE DI TENSIONE DALLA FONDAMENTALE ALLA 55° [V]	VL1-N, VL2-N, VL3-N
ARMONICHE DI CORRENTE DALLA FONDAMENTALE ALLA 55° [A]	IL1, IL2, IL3
ARMONICHE DI TENSIONE DALLA 2° ALLA 55° [% RISPETTO ALLA FONDAMENTALE]	VL1-N, VL2-N, VL3-N
ARMONICHE DI CORRENTE DALLA 2° ALLA 55° [% RISPETTO ALLA FONDAMENTALE]	IL1, IL2, IL3

6. TEMPI DI MISURA E CALCOLO

6.1. TEMPI DI CAMPIONAMENTO

Il tempo di campionamento dei canali di corrente è di 8000 campioni per secondo.

Il tempo di campionamento dei canali di tensione è di 8000 campioni per secondo

6.2. TEMPI DI ASSESTAMENTO PER I VALORI RMS

Definiamo il tempo di assestamento (settling time) il tempo necessario al valore RMS per raggiungere il 99.5% del fondo scala in risposta ad un ingresso da 0% al 100% del fondo scala.

Per le correnti RMS il settling time è di 580 ms per ingresso TA con uscita corrente o tensione

Per le correnti RMS il settling time è di 700 ms per ingresso Rogowski

Per le tensioni RMS il settling time è di 580 ms.

6.3. TEMPI DI RISPOSTA DELL'USCITA ANALOGICA

Analog Output Response Time: Typical 10 ms (10-90%)

6.4. TEMPI DI AGGIORNAMENTO DEI REGISTRI RELATIVI ALL'ANALISI ARMONICA (SOLO MODELLI R203)

I singoli registri relativi alle singole armoniche sono aggiornati ogni 30 secondi.

6.5. TEMPI DI AGGIORNAMENTO DEI REGISTRI MODBUS (SOLO MODELLI R203)

Il tempo di aggiornamento delle misure nei registry Modbus è riportato nella seguente tabella:

Modbus Registers	Typical Refresh time for Phase L1, L2 and L3 [ms]
Voltage phase to phase L1, L2, L3	200
Current L1, L2, L3, N	25
Active Power L1, L2, L3	25

7. PRECISIONI DELLE MISURE A 23°C

Tipo di misura	Precisione a 23°C
Corrente (TA uscita corrente)	0.2% della misura con range dinamico 1000:1
Corrente (TA uscita tensione)	0.2% della misura con range dinamico 1000:1
Corrente (Rogowski)	0.5% della misura con range dinamico 1000:1
Tensione	0.2% della misura con range dinamico 1000:1
Potenza Attiva (misura di corrente con TA in corrente o tensione)	0.5% della misura con PF=1 e range dinamico 2000:1
Potenza Reattiva (misura di corrente con TA)	0.5% della misura con PF=0 e range dinamico 2000:1
Potenza Attiva (misura di corrente con Rogowski)	0.5% della misura con PF=1 e range dinamico 500:1
Potenza Reattiva (misura di corrente con Rogowski)	0.5% della misura con PF=0 e range dinamico 500:1

8. FONDO SCALA DEGLI INGRESSI PER SENSORI ROGOWSKI

INGRESSO	F.S. 50 Hz (FATTORE DI FORMA 2) [A]	F.S. 60 Hz (FATTORE DI FORMA 2) [A]
ROGOWSKI 1000A/333mV (750A@50Hz)	750	600
ROGOWSKI 1000A/100mV (1250A@50Hz)	1250	1000
ROGOWSKI 1000A/83mV (750A@50Hz)	750	600
ROGOWSKI 1000A/25mV (1250A@50Hz)	1250	1000
ROGOWSKI 1000A/100 mV (2500A@50Hz)	2500	2000
ROGOWSKI 1000A/100 mV (625A@50Hz)	625	500
ROGOWSKI 1000A/100 mV (312A@50Hz)	312	250

9. DATALOGGER (SOLO MODELLI R203)

Il dispositivo dispone di due differenti datalogger (abilitabili anche contemporaneamente):

- un datalogger dati a tempo di campionamento, configurabile con velocità massima di 1 campione al secondo;
 - un datalogger degli eventi, ovvero registra l'evento configurato (un solo evento) e la data/ora in cui è avvenuto;
- È possibile scaricare in un dispositivo i dati di entrambi i datalogger tramite webserver, il formato è testo separato da virgole (standard csv).

9.1. DATALOGGER DATI A TEMPO

Il datalogger dati a tempo permette di archiviare nella flash interna del dispositivo un massimo di 30 variabili (tag) per un numero massimo di 65504 campioni ciascuno da massimo 30 variabili.

Il tempo di campionamento può variare tra 1 secondo (minimo) a 24 h (massimo).

È anche possibile fra partire (start) e fermare (stop) il datalogger tramite lo stato di un ingresso digitale.

Esempio del contenuto del file csv del datalogger a tempo:

```
DATE/TIME;V31_MIN;V2N_AVG_MIN;V2N_AVG_MAX;V3N;V23_AVG_MAX;V3N_MIN;V3N_MAX;V31_AVG_MAX;Vsys;Vsys_AVG;Vsys_MIN;Vsys_MAX;Vsys_AVG_MIN;
2023-12-07-14-52-06;0.000;0.002;0.119;0.085;0.058;0.081;0.089;0.058;0.316;0.058;0.000;0.316;0.000;
2023-12-07-14-52-36;0.000;0.002;0.119;0.084;0.069;0.081;0.090;0.069;0.316;0.069;0.000;0.316;0.000;
2023-12-07-14-53-19;0.000;0.002;0.117;0.086;0.005;0.081;0.089;0.005;0.316;0.005;0.000;0.316;0.000;
2023-12-07-14-53-49;0.000;0.002;0.117;0.085;0.016;0.081;0.089;0.016;0.316;0.016;0.000;0.316;0.000;
2023-12-07-14-54-19;0.000;0.002;0.117;0.085;0.026;0.081;0.089;0.026;0.316;0.026;0.000;0.316;0.000;
2023-12-07-14-54-49;0.000;0.002;0.117;0.087;0.037;0.081;0.090;0.037;0.316;0.037;0.000;0.316;0.000;
2023-12-07-14-55-19;0.000;0.002;0.117;0.085;0.047;0.081;0.090;0.047;0.316;0.047;0.000;0.316;0.000;
2023-12-07-14-55-49;0.000;0.002;0.117;0.086;0.058;0.081;0.090;0.058;0.316;0.058;0.000;0.316;0.000;
2023-12-07-14-56-20;0.000;0.002;0.117;0.085;0.069;0.081;0.090;0.069;0.316;0.069;0.000;0.316;0.000;
2023-12-07-14-56-50;0.000;0.002;0.117;0.086;0.079;0.081;0.090;0.079;0.316;0.079;0.000;0.316;0.000;
2023-12-07-14-57-20;0.000;0.002;0.117;0.086;0.090;0.081;0.090;0.090;0.316;0.090;0.000;0.316;0.000;
2023-12-07-14-57-50;0.000;0.002;0.117;0.085;0.100;0.080;0.090;0.100;0.316;0.100;0.000;0.316;0.000;
2023-12-07-14-58-20;0.000;0.002;0.117;0.085;0.111;0.080;0.090;0.111;0.316;0.111;0.000;0.316;0.000;
2023-12-07-14-58-50;0.000;0.002;0.117;0.082;0.121;0.080;0.090;0.121;0.316;0.121;0.000;0.316;0.000;
2023-12-07-14-59-20;0.000;0.002;0.117;0.083;0.132;0.080;0.090;0.132;0.316;0.132;0.000;0.316;0.000;
2023-12-07-14-59-50;0.000;0.002;0.117;0.083;0.142;0.080;0.090;0.142;0.316;0.142;0.000;0.316;0.000;
```

9.2. DATALOGGER DEGLI EVENTI

Nel caso si debba registrare la data/ora di un particolare evento è possibile usare il datalogger degli eventi.

Questo può registrare un massimo di 4096 campioni di un singolo evento con relativo tag temporale.

È possibile definire un unico evento indicando la variabile da monitorare e la relativa soglia (o finestra di allarme).

Esempio del contenuto del file csv del datalogger degli eventi:

```
DATE/TIME;EVENT TYPE;
2023-12-07-15-24-42;ALARM;
2023-12-07-15-24-45;ALARM RETURN;
2023-12-07-15-24-47;ALARM;
2023-12-07-15-24-49;ALARM RETURN;
```

10. **FUNZIONI SMART PER L'INVIO DEI DATI E DEGLI EVENTI AI CLOUD (SOLO MODELLI R203)**

I valori acquisiti dai datalogger possono essere inviati direttamente ai cloud scegliendo tra i protocolli MQTT(s), Http(s) o FTP.

È possibile scegliere l'invio con un solo protocollo tra Mqtt(s), http(s) o FTP.

10.1. **PROTOCOLLO MQTT(s) CLIENT**

L'MQTT è il protocollo più utilizzato per le applicazioni IOT.

"MQTT" sta per MQ Telemetry Transport. Si tratta di un protocollo di messaggistica di pubblicazione/sottoscrizione, estremamente semplice e leggero, progettato per dispositivi con reti a bassa larghezza di banda, ad alta latenza o inaffidabili. I principi di progettazione sono quelli di ridurre al minimo i requisiti di larghezza di banda di rete e di risorse dei dispositivi, cercando al contempo di garantire l'affidabilità e un certo grado di garanzia della consegna. Questi principi si rivelano ideali per l'emergente mondo "machine-to-machine" (M2M) o "Internet delle cose."

Per maggiori informazioni sul protocollo MQTT vedi



La versione MQTT supportata è la 3.1.1

L'invio tramite MQTT è parametrizzabile attraverso l'utilizzo di una semplice sintassi, è possibile aggiungere anche il timestamp (in formato data/ora minuti secondi o in secondi dal 1/1/1970 "epoch").

Tramite Mqtt è anche possibile inserire una soglia oltre la quale inviare o meno i dati.

10.2. **PROTOCOLLO HTTP(s) POST**

La comunicazione con i Cloud può avvenire tramite protocollo HTTP con una chiamata di tipo POST.

I dati inviati al server sono contenuti nel body della richiesta HTTP.

L'invio tramite http è parametrizzabile attraverso l'utilizzo di una semplice sintassi, è possibile aggiungere anche il timestamp (in formato data/ora minuti secondi o in secondi dal 1/1/1970 "epoch").

10.3. **PROTOCOLLO FTP CLIENT**

L'invio dei dati può avvenire anche verso un server FTP.

In questo caso i log sono inviati direttamente nel formato csv prodotto dal datalogger.

10.4. *INVIO DEI DATI ED EVENTI CON O SENZA RECUPERO*

Se si imposta un tempo di invio dei log verso i cloud maggiore o uguale a 30 secondi è possibile attivare la funzione di recupero.

In questa modalità i dati e gli eventi sono inviati con il tempo di invio configurato ma, in caso vi fosse una mancanza di comunicazione, tutto ciò che non è stato spedito sarà inviato alla successiva connessione.

11. CONNESSIONE DEI DISPOSITIVI AD UNA RETE

11.1. MODELLI R203 / R203-E

La configurazione di fabbrica dell'indirizzo IP è:

Indirizzo statico: 192.168.90.101

Non devono, quindi, essere inseriti più dispositivi sulla stessa rete con lo stesso ip statico.

Se si vogliono connettere più dispositivi sulla stessa rete è necessario cambiare la configurazione dell'indirizzo IP tramite il software Easy Setup 2.



ATTENZIONE!

**NON CONNETTERE 2 O PIU' DISPOSITIVI CON LA CONFIGURAZIONE DI FABBRICA SULLA STESSA RETE PENA IL NON FUNZIONAMENTO DELL'INTERFACCIA ETHERNET
(CONFLITTO DI INDIRIZZI IP 192.168.90.101)**

Qualora venga attivata la modalità di indirizzamento con DHCP e non riceva un indirizzo IP entro 1 minuto il dispositivo imposterà un indirizzo IP di errore fisso:

169.254.x.y

Dove x.y sono gli ultimi due valori del MAC ADDRESS.

In questo modo è possibile installare più I/O della serie R e configurare in un secondo momento l'indirizzo IP anche su reti prive di un server DHCP.

11.2. MODELLI R203-P

I dispositivi Profinet IO vengono forniti senza un indirizzo IP.

ATTENZIONE!

I DISPOSITIVI R203 CON PROTOCOLLO PROFINET IO VENGONO FORNITI SENZA UN INDIRIZZO IP (0.0.0.0).

POSSONO QUINDI ESSERE INSERITI PIU' DISPOSITIVI NELLA STESSA RETE PROFINET ED INDIVIDUATI TRAMITE SCAN DELLA RETE PROFINET STESSA

PER IMPOSTARE UN INDIRIZZO IP (AD ESEMPIO PER ACCEDERE AL WEBSERVER O PER CONNETTERSI AL TOOL SENECA DISCOVERY DEVICE) UTILIZZARE L'AMBIENTE PROFINET DI CONFIGURAZIONE OPPURE FORZARE L'INDIRIZZO 192.168.90.101 CON L'APPOSITO DIP SWITCH

12. COPIA I/O TRAMITE LA FUNZIONE PEER TO PEER SENZA CABLAGGI (SOLO MODELLI R203)

I dispositivi della serie "R" possono essere utilizzati per copiare e aggiornare in tempo reale un canale di ingresso su un canale di uscita remoto senza l'ausilio di un controller master.

Ad esempio, un ingresso digitale può essere copiato su un dispositivo di uscita digitale remoto:



Si noti che non è necessario alcun controller perché la comunicazione è gestita direttamente dai dispositivi della serie R.

È possibile effettuare una connessione più sofisticata, ad esempio è possibile copiare gli input su dispositivi remoti della serie R diversi (da Dispositivo 1 Ingresso 1 a Dispositivo 2 Uscita1, Dispositivo 1 Ingresso 2 a Dispositivo 3 Uscita 1 ecc ...)

È anche possibile copiare un ingresso su un'uscita di più dispositivi remoti:

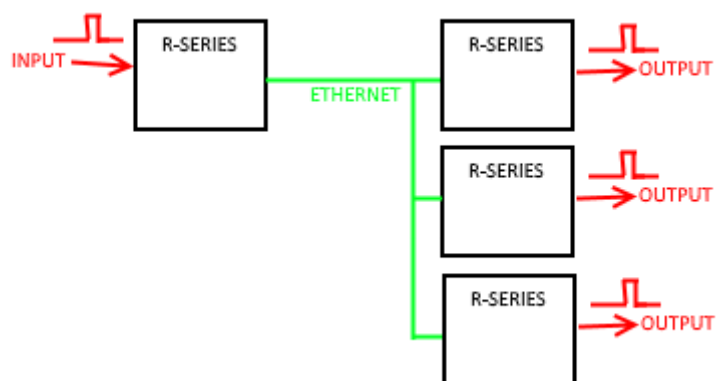

Ogni dispositivo della serie R può inviare e ricevere un massimo di 32 ingressi.

13. **WEBSERVER**

13.1. **ACCESSO AL WEBSERVER**

L'accesso al webservice avviene tramite l'utilizzo di un browser web digitando direttamente l'indirizzo ip del dispositivo.

Per conoscere l'indirizzo ip del dispositivo utilizzare la funzione "cerca" del software "Easy Setup 2" oppure del software "Seneca Discovery Device"

Utilizzando la configurazione di fabbrica (attenzione al modello acquistato, ad esempio per i modelli -P è necessario forzare l' IP da dip switch) si ha:

<http://192.168.90.101>

Al primo accesso verrà richiesto lo username e la password.

I valori di default sono:

User Name: admin

Password: admin

ATTENZIONE!

DOPO IL PRIMO ACCESSO CAMBIARE USER NAME E PASSWORD AL FINE DI IMPEDIRE L'ACCESSO AL DISPOSITIVO A CHI NON È AUTORIZZATO.

ATTENZIONE!

SE I PARAMETRI DI ACCESSO AL WEBSERVER SONO STATI SMARRITI È NECESSARIO RIPORTARE A DEFAULT LA CONFIGURAZIONE TRAMITE I DIP SWITCH

ATTENZIONE!

NEI DISPOSITIVI R203-P PRIMA DI ACCEDERE AL WEBSERVER SCONNETTERE IL DISPOSITIVO DALLA RETE PROFINET IO

14. DIAGNOSTICA DI CONNESSIONE

Il dispositivo include una diagnostica di connessione avanzata disponibile nel webserver e nei protocolli di comunicazione.

Se il sistema rileva un errore di connessione il led WIRING ERROR lampeggerà, a questo punto è possibile verificare il motivo dell'errore:

VOLTAGE CYCLIC DIRECTION Nel caso sia "Wrong" indica che la connessione delle voltmetriche non rispetta il senso ciclico R (L1) -> S (L2) -> T (L3). Per risolvere il problema cablare nuovamente gli ingressi di tensione. Nel caso sia "Correct" passare alla prossima voce. Questo non è un vero errore di connessione (e quindi non fa lampeggiare il led WIRING ERROR).

CURRENT L1..L3 Nel caso sia "STRAIGHT" indica che il TA relativo all'ingresso i-esimo è connesso correttamente. Nel caso sia "INVERTED" indica che il TA relativo all'ingresso i-esimo è rovescio (invertire il cablaggio dei morsetti del TA). Quando le tre correnti sono "STRAIGHT" è possibile passare alla prossima voce.



ATTENZIONE!

**SE IL DISPOSITIVO È CONNESSO AD UN GENERATORE È CORRETTO CHE CURRENT L1..L3 SIANO TUTTI "INVERTED".
IN QUESTO CASO NEL CAMPO "ENERGY" APPARIRÀ LA DICITURA "PRODUCTION".**

L1..L3 CONNECTION Se questo parametro vale "CORRECT" significa che è stato cablato correttamente l'ingresso L-i esimo di corrente e l'ingresso L-i-esimo di tensione.

Nel caso di "ERROR" significa che, ad esempio la fase Li-esima di corrente non coincide con la fase Li-esima di tensione, quindi un errore di cablaggio delle amperometriche o delle voltmetriche (ad esempio la corrente L1 è stata connessa all'ingresso di corrente L2).

È, infatti, possibile cablare rispettando il senso ciclico delle tensioni e il verso corretto dei TA ma non avere la corrispondenza tra le fasi delle tensioni e quelle delle correnti.

In questo caso cablare nuovamente il dispositivo (ad esempio è possibile spostare le voltmetriche di 1 posizione rispettando sempre il senso ciclico fino a far sparire questo errore).

Nel caso di configurazioni di installazione non standard è possibile configurare un parametro per ignorare la diagnostica.

15. CONFIGURAZIONE DEL DISPOSITIVO TRAMITE WEBSERVER (SOLO MODELLI R203 / R203-E)

Per la configurazione del dispositivo accedere al webserver e selezionare la sezione di interesse.

Dopo che è stata fatta una modifica alla configurazione è necessario confermare le modifiche inserendo l'account e la password da amministratore con il pulsante "**APPLY**".

Il pulsante **Reboot** effettua il reboot del dispositivo (non necessario in caso di cambio di configurazione).

Il pulsante **Default** riporta a default tutti i parametri della pagina.

15.1. SEZIONE COMMUNICATION SETUP

DHCP (ETH) (default: Disabled)

Imposta il client DHCP per l'ottenimento automatico di un indirizzo IP.

IP ADDRESS STATIC (ETH) (default: 192.168.90.101)

Imposta l'indirizzo statico del dispositivo. Attenzione a non inserire nella stessa rete dispositivi con lo stesso indirizzo IP.

IP MASK STATIC (ETH) (default: 255.255.255.0)

Imposta la maschera per la rete IP.

GATEWAY ADDRESS STATIC (ETH) (default: 192.168.90.1)

Imposta l'indirizzo del gateway.

DNS (default: 8.8.8.8)

Imposta il Domain Name System.

PROTECT CONFIGURATION (default: Disabled)

Permette di abilitare o no la protezione con password in lettura e scrittura della configurazione (anche dell'indirizzo IP) tramite il software Easy Setup 2 o Seneca Discovery Tool. La password è la stessa che fornisce l'accesso al webserver.

ATTENZIONE!

**SE È ABILITATA LA PROTEZIONE DELLA CONFIGURAZIONE NON SARA' POSSIBILE
LEGGERE/SCRIVERE LA CONFIGURAZIONE DEL DISPOSITIVO SENZA CONOSCERE LA PASSWORD
AMMINISTRATORE.**

**NEL CASO DI SMARRIMENTO DELLA PASSWORD SARA' POSSIBILE RIPORTARE A DEFAULT IL
DISPOSITIVO TRAMITE I DIP SWITCH**

MODBUS SERVER PORT (ETH) (solo modelli R203) (default: 502)

Imposta la porta di comunicazione per il server Modbus TCP-IP.

MODBUS SERVER STATION ADDRESS (ETH) (solo modelli R203) (default: 1)

Attivo solo se lo è anche il Modbus Passtrough, imposta lo station address del modbus TCP-IP server.

⚠ ATTENZIONE!

IL MODBUS SERVER RISPONDERA' A QUALSIASI STATION ADDRESS SOLO SE LA MODALITA' MODBUS PASS THROUGH È DISABILITATA.

MODBUS PASSTROUGH (ETH) (solo modelli R203) (default: disabled)

Imposta la modalità di conversione da Modbus TCP-IP a Modbus RTU seriale (vedi capitolo 14).

MODBUS TCP-IP CONNECTION TIMEOUT [sec] (ETH) (solo modelli R203) (default: 60)

Imposta il timeout della connessione TCP-IP per la modalità Modbus TCP-IP server e Passthrough.

P2P SERVER PORT (solo modelli R203) (default: 50026)

Imposta la porta di comunicazione per il server P2P.

WEBSERVER ACCOUNT NAME (default: admin)

Imposta lo user name per l'accesso al web server.

USER ACCOUNT CONFIGURATION/WEBSERVER PASSWORD (default: admin)

Imposta la password per l'accesso al web server e alla lettura/scrittura della configurazione (se abilitato)

WEBSERVER PORT (default: 80)

Imposta la porta di comunicazione per il web server.

BAUDRATE MODBUS RTU (SER) (solo modelli R203) (default: 38400 baud)

Imposta il baud rate per la porta di comunicazione RS485.

DATA MODBUS RTU (SER) (solo modelli R203) (default: 8 bit)

Imposta il numero di bit per la porta di comunicazione RS485.

PARITY MODBUS RTU (SER) (solo modelli R203) (default: None)

Imposta la parità per la porta di comunicazione RS485.

STOP BIT MODBUS RTU (SER) (solo modelli R203) (default: 1 bit)

Imposta il numero di bit di stop per la porta di comunicazione RS485.

MODBUS PASSTROUGH SERIAL TIMEOUT (solo modelli R203) (default: 100ms)

Attivo solo se è attivata la modalità Passthrough, imposta il tempo di attesa massimo prima di inviare un nuovo pacchetto da TCP-IP alla seriale. Va impostato in base al tempo di risposta più lungo di tutti i device presenti sulla seriale RS485.

15.2. SEZIONE MEASURES SETUP

CONNECTION TYPE

Imposta il tipo di connessione da effettuare.

TA TYPE

Seleziona il tipo di sensore e il valore del secondario del TA da utilizzare tra:

TA con uscita corrente

TA con uscita in mV

Sensore Rogowski

TA RATIO

Imposta l'eventuale rapporto di TA, il valore da inserire è relativo al primario, esempio:

Se si è installato un TA 50/5 andrà inserito come primario il valore 50 e sul parametro "TA TYPE" il valore 5.

TV TYPE

Imposta il tipo di Trasformatore di Tensione

NETWORK FREQUENCY [Hz]

Imposta l'impianto a 50 o 60 Hz.

AVERAGE POWER WINDOW

Imposta il tempo su cui effettuare la misura dei valori medi

USER CALIBRATION VOLTAGE

Imposta un eventuale coefficiente moltiplicativo per la misura di tensione.

USER CALIBRATION CURRENT

Imposta un eventuale coefficiente moltiplicativo per la misura di corrente.

CUTOFF CURRENT [A]

Imposta un valore di corrente (al primario) sotto il quale i contatori vengono fermati.

USER CALIBRATION ACTIVE ENERGY

Imposta un eventuale coefficiente moltiplicativo per l'energia attiva.

USER CALIBRATION REACTIVE ENERGY

Imposta un eventuale coefficiente moltiplicativo per l'energia reattiva.

15.3. SEZIONE SETUP ANALOG AND DIGITAL OUTPUT

ANALOG OUTPUT RETRANSMITTED PHASE

Seleziona quale fase viene portata nell'uscita analogica (selezionabile tra L1, L2, L3)

ANALOG OUTPUT RETRANSMITTED VALUE

Seleziona quale variabile viene portata nell'uscita analogica (selezionabile tra voltage RMS, current RMS, active power, power factor, reactive factor, apparent power, frequency)

ANALOG OUTPUT TYPE

Seleziona il tipo di uscita analogica

DIGITAL OUTPUT LOGIC

Seleziona la logica dell'uscita (normalmente alta o bassa).

DIGITAL OUTPUT FUNCTION

Seleziona il tipo di funzione che deve svolgere l'uscita digitale

DIGITAL OUTPUT SOURCE

Seleziona la variabile da portare nell'uscita digitale

15.4. **SEZIONE SETUP DIGITAL INPUT**

DIGITAL INPUT 1 MODE

Seleziona il comportamento dell'ingresso digitale 1 se ingresso oppure start/stop per il datalogger.

Nella modalità "start/stop datalogger" quando l'ingresso digitale va alto il datalogger inizia a registrare (start), quando l'ingresso digitale va basso il datalogger si ferma (stop).

DIGITAL INPUT 2 MODE

Seleziona il comportamento dell'ingresso digitale 2 se ingresso oppure start/stop per il datalogger.

Nella modalità "start/stop datalogger" quando l'ingresso digitale va alto il datalogger inizia a registrare (start), quando l'ingresso digitale va basso il datalogger si ferma (stop).

DIGITAL INPUT FILTER [ms]

Imposta il tempo di filtro per gli ingressi digitali, utilizzato come filtraggio per i contatori.

15.5. **SEZIONE SETUP DATALOGGER (SOLO MODELLI R203)**

EVENT MODE

Seleziona l'evento di allarme di massima, minima o a finestra.

RETURN EVENT

Abilita o no anche l'evento di uscita dall'allarme

EVENT SOURCE

Seleziona la variabile da utilizzare per l'evento di allarme

EVENT HIGH THRESHOLD

Imposta la soglia che rappresenta l'evento di allarme alto.

EVENT LOW THRESHOLD

Imposta la soglia che rappresenta l'evento di allarme basso.

HYSTERESIS

Rappresenta l'isteresi dell'evento

DATA LOGGER SAMPLE TIME

Abilita/Disabilita e imposta il tempo di campionamento per il datalogger a tempo.

DATA RECOVERY

Se il sample time è $\geq 30s$ è possibile scegliere se l'invio dei dati deve avvenire con o senza recupero in caso di mancanza momentanea di comunicazione.

DATALOGGER CONNECTOR

Permette di scegliere se inviare i dati attraverso i protocolli MQTT, HTTP o FTP.

DATA LOGGER SOURCE 1...30

Seleziona la variabile i-esima da inserire nel datalogger a tempo.

15.6. SEZIONE SETUP FTP (SOLO MODELLI R203)

In questa sezione è possibile configurare l'invio dei log a tempo in un server FTP. L'invio dei log avviene senza crittografia.

Premendo il pulsante "**FTP SEND NOW**" viene forzato l'invio di un file di log, sarà possibile testare il funzionamento dei dati inseriti.

FTP DATALOGGER SENDING

Qui è possibile selezionare la frequenza di invio del log, nel caso di invio settimanale è possibile scegliere anche quali giorni e a che ora spedire.

FTP SERVER

Imposta l'IP o il nome del server FTP.

FTP SERVER PORT

Imposta la porta FTP del server

FTP USER NAME

Imposta lo user name per l'accesso all'FTP del server

FTP PASSWORD

Imposta la password per l'accesso all'FTP del server

FTP FOLDER

Imposta la cartella su cui scrivere i log (lasciare vuota per root)

FTP DEVICE NAME

Impostare il nome che si vuole dare all' R203, questo sarà la parte iniziale del nome del file nel server.

ATTENZIONE!

NEL CASO DI MANCANZA DI CONNESSIONE CON IL SERVER FTP IL DISPOSITIVO CONTINUERA' COMUNQUE A REGISTRARE I LOG FINCHÈ C'È SPAZIO IN MEMORIA. ALLA RIPRESA DELLA CONNESSIONE INVIERA' IN UN UNICO FILE I LOG NON ANCORA INVIATI.

ATTENZIONE!

IL FORMATO DEI FILE INVIATI È LO STESSO DI QUELLO CHE SI OTTIENE SCARICANDO IL DATABASE A TEMPO DA WEBSERVER (FORMATO CSV).

15.7. **SEZIONE CONNECTIONS DIAGNOSTIC**

In questa sezione è possibile verificare se la connessione al dispositivo è stata effettuata correttamente. È anche possibile scambiare la relazione CORRENTE – TENSIONE di ciascuna fase senza ricablare il sistema. Nel caso di connessioni particolari è possibile configurare il parametro CONNECTION DIAGNOSTIC su “DISABLE” così che il sistema ignori gli errori di connessione.

15.8. **SEZIONE MQTT CONFIGURATION (SOLO MODELLI R203)**

MAX FAILURE COUNTER

Numero Massimo di errori prima di attendere il tempo del parametro “WAIT AFTER FAILURE”

WAIT AFTER FAILURE (minutes)

Tempo di attesa prima di tentare una nuova connessione

CLIENT ID

Definisce il Client ID usato nel protocollo MQTT

BROKER HOST

Definisce l'host name del broker MQTT

BROKER PORT

Definisce la porta del broker MQTT

USE WEBSOCKETS

Permette di attivare la comunicazione MQTT tramite Websockets

KEEP ALIVE INTERVAL (seconds)

Questo parametro definisce il Keep alive il quale assicura che la connessione tra il broker e il client sia ancora aperta e che il broker e il client siano consapevoli di essere connessi. Quando il client stabilisce una connessione al broker, comunica al broker un intervallo di tempo in secondi. Questo intervallo definisce il periodo di tempo massimo durante il quale il broker e il client possono non comunicare tra loro

CLEAN SESSION

Questo parametro definisce la “clean session”.

Quando il flag di clean session è impostato su true, il client non desidera una sessione persistente. Se il client si disconnette per qualsiasi motivo, tutte le informazioni e i messaggi accodati da una precedente sessione vengono persi.

MESSAGE RETAIN

Normalmente se un publisher pubblica un messaggio su un topic a cui nessuno è sottoscritto, il messaggio viene semplicemente scartato dal broker. Tuttavia il publisher può dire al broker di conservare l'ultimo messaggio di quel topic

QUALITY OF SERVICE

Questo parametro definisce il QOS del protocollo MQTT.

Può essere selezionato tra

QOS 0 (solo una volta, senza ack)

QOS 1 (almeno una volta, con ack)

QOS 2 (solo una volta, con ack e rinvio)

AUTHENTICATION

Questo parametro definisce se deve essere utilizzata l'autenticazione con utente / password per l'accesso al broker

USERNAME

Username del broker

PASSWORD

Password del broker

SSL/TLS

Definisce se attivare il protocollo criptato di sicurezza SSL/TLS 1.2

CLIENT CERTIFICATE REQUIRED

Definisce se è necessario gestire i certificati per la connessione SSL/TLS

CHECK CERTIFICATES

Verifica che i certificati siano validi

LOG ON CHANGE

Aggiorna i valori sul broker solo su cambiamento e non più a tempo

HYSTERESIS

Valore di isteresi per I dati analogici (un'isteresi per tutte le variabili configurate) da inviare con la funzione "Log on change"

PUBLISH WITH MULTIPLE TAGS

Questo parametro definisce se la publish contiene più tag o se il dispositivo deve inviare una publish per ciascun tag

PUBLISH TOPIC FOR LOGS

Seleziona il nome del topic per i log utilizzando la seguente tabella:

%c	Device Client ID
%m	Device MAC Address
%j[field]	Aggiunge i doppi apici " a [field]. I doppi apici rappresentano una stringa in JSON

Ad esempio:

Se:

Device Client ID = Padova13

Publish Topic for Logs = seneca/%c/data

Si avrà che i log dei dati sono inviati al topic: Seneca/Padova13/data

PUBLISH PAYLOAD FOR LOGS

Seleziona il formato che deve essere utilizzato per il payload utilizzando la seguente tabella:

%c	Device Client ID
%m	Device MAC Address
%d	data-ora
%t	timestamp (numero di secondi dal 01/01/1970)
%tms	timestamp (numero di millisecondi dal 01/01/1970)
%b	bulk (formato specificato in "Publish Bulk Format")
%n	Nome del tag (solo per "Publish Bulk Format")
%i	Id univoco della variabile
%v	Valore del tag (solo in "Publish Bulk Format")
%j[field]	Aggiunge i doppi apici " a [field]. I doppi apici rappresentano una stringa in JSON

Nota: il placeholder %i aggiunge un ID univoco alla variabile da pubblicare secondo la seguente tabella:

%i (ID)	VARIABLE
1	V1N
2	V1N_AVG
3	V1N_MIN
4	V1N_MAX

5	V1N_AVG_MIN
6	V1N_AVG_MAX
7	V2N
8	V2N_AVG
9	V2N_MIN
10	V2N_MAX
11	V2N_AVG_MIN
12	V2N_AVG_MAX
13	V3N
14	V3N_AVG
15	V3N_MIN
16	V3N_MAX
17	V3N_AVG_MIN
18	V3N_AVG_MAX
19	AN
20	AN_AVG
21	AN_MIN
22	AN_MAX
23	AN_AVG_MIN
24	AN_AVG_MAX
25	V12
26	V12_AVG
27	V12_MIN
28	V12_MAX
29	V12_AVG_MIN
30	V12_AVG_MAX
31	V23
32	V23_AVG
33	V23_MIN
34	V23_MAX
35	V23_AVG_MIN
36	V23_AVG_MAX
37	V31
38	V31_AVG
39	V31_MIN
40	V31_MAX
41	V31_AVG_MIN
42	V31_AVG_MAX
43	Vsys
44	Vsys_AVG
45	Vsys_MIN
46	Vsys_MAX
47	Vsys_AVG_MIN

48	Vsys_AVG_MAX
49	A1
50	A1_AVG
51	A1_MIN
52	A1_MAX
53	A1_AVG_MIN
54	A1_AVG_MAX
55	A2
56	A2_AVG
57	A2_MIN
58	A2_MAX
59	A2_AVG_MIN
60	A2_AVG_MAX
61	A3
62	A3_AVG
63	A3_MIN
64	A3_MAX
65	A3_AVG_MIN
66	A3_AVG_MAX
67	Asys
68	Asys_AVG
69	Asys_MIN
70	Asys_MAX
71	Asys_AVG_MIN
72	Asys_AVG_MAX
73	P1
74	P1_AVG
75	P1_MIN
76	P1_MAX
77	P1_AVG_MIN
78	P1_AVG_MAX
79	P2
80	P2_AVG
81	P2_MIN
82	P2_MAX
83	P2_AVG_MIN
84	P2_AVG_MAX
85	P3
86	P3_AVG
87	P3_MIN
88	P3_MAX
89	P3_AVG_MIN
90	P3_AVG_MAX

91	Psys
92	Psys_AVG
93	Psys_MIN
94	Psys_MAX
95	Psys_AVG_MIN
96	Psys_AVG_MAX
97	S1
98	S1_AVG
99	S1_MIN
100	S1_MAX
101	S1_AVG_MIN
102	S1_AVG_MAX
103	S2
104	S2_AVG
105	S2_MIN
106	S2_MAX
107	S2_AVG_MIN
108	S2_AVG_MAX
109	S3
110	S3_AVG
111	S3_MIN
112	S3_MAX
113	S3_AVG_MIN
114	S3_AVG_MAX
115	Ssys
116	Ssys_AVG
117	Ssys_MIN
118	Ssys_MAX
119	Ssys_AVG_MIN
120	Ssys_AVG_MAX
121	Q1
122	Q1_AVG
123	Q1_MIN
124	Q1_MAX
125	Q1_AVG_MIN
126	Q1_AVG_MAX
127	Q2
128	Q2_AVG
129	Q2_MIN
130	Q2_MAX
131	Q2_AVG_MIN
132	Q2_AVG_MAX
133	Q3

134	Q3_AVG
135	Q3_MIN
136	Q3_MAX
137	Q3_AVG_MIN
138	Q3_AVG_MAX
139	Qsys
140	Qsys_AVG
141	Qsys_MIN
142	Qsys_MAX
143	Qsys_AVG_MIN
144	Qsys_AVG_MAX
145	TPF1
146	TPF1_AVG
147	TPF1_MIN
148	TPF1_MAX
149	TPF1_AVG_MIN
150	TPF1_AVG_MAX
151	TPF2
152	TPF2_AVG
153	TPF2_MIN
154	TPF2_MAX
155	TPF2_AVG_MIN
156	TPF2_AVG_MAX
157	TPF3
158	TPF3_AVG
159	TPF3_MIN
160	TPF3_MAX
161	TPF3_AVG_MIN
162	TPF3_AVG_MAX
163	TPFsys
164	TPFsys_AVG
165	TPFsys_MIN
166	TPFsys_MAX
167	TPFsys_AVG_MIN
168	TPFsys_AVG_MAX
169	THD-V1N
170	THD-V1N_AVG
171	THD-V1N_MIN
172	THD-V1N_MAX
173	THD-V1N_AVG_MIN
174	THD-V1N_AVG_MAX
175	THD-V2N
176	THD-V2N_AVG

177	THD-V2N_MIN
178	THD-V2N_MAX
179	THD-V2N_AVG_MIN
180	THD-V2N_AVG_MAX
181	THD-V3N
182	THD-V3N_AVG
183	THD-V3N_MIN
184	THD-V3N_MAX
185	THD-V3N_AVG_MIN
186	THD-V3N_AVG_MAX
187	f
188	THD-A1N
189	THD-A1N_AVG
190	THD-A1N_MIN
191	THD-A1N_MAX
192	THD-A1N_AVG_MIN
193	THD-A1N_AVG_MAX
194	THD-A2N
195	THD-A2N_AVG
196	THD-A2N_MIN
197	THD-A2N_MAX
198	THD-A2N_AVG_MIN
199	THD-A2N_AVG_MAX
200	THD-A3N
201	THD-A3N_AVG
202	THD-A3N_MIN
203	THD-A3N_MAX
204	THD-A3N_AVG_MIN
205	THD-A3N_AVG_MAX
206	+WH1
207	+WH2
208	+WH3
209	+Wh
210	-WH1
211	-WH2
212	-WH3
213	-Wh
214	VAh1
215	VAh2
216	VAh3
217	VAh
218	+VARh1-L[Q1]
219	+VARh2-L[Q1]

220	+VARh3-L[Q1]
221	+VARh-L[Q1]
222	-VARh1-C[Q4]
223	-VARh2-C[Q4]
224	-VARh3-C[Q4]
225	-VARh-C[Q4]
226	-VARh1-L[Q3]
227	-VARh2-L[Q3]
228	-VARh3-L[Q3]
229	-VARh-L[Q3]
230	+VARh1-C[Q2]
231	+VARh2-C[Q2]
232	+VARh3-C[Q2]
233	+VARh-C[Q2]
234	Wh
235	VARh
236	VARh-L[Q1Q3]
237	VARh-C[Q2Q4]
238	VAh
239	COUNTER 1
240	COUNTER 2
241	DIGITAL_IN_1
242	DIGITAL_IN_2
243	DIGITAL_OUT_1
244	DIGITAL_OUT_2

PUBLISH BULK FORMAT

Seleziona il formato per il "bulk mode" secondo la seguente tabella:

%c	Device Client ID
%m	Device MAC Address
%d	Data/ora
%t	timestamp (numero di secondi dal 01/01/1970)
%n	Nome del tag (solo per "Publish Bulk Format")
%v	Valore del tag (solo in "Publish Bulk Format")
%j[field]	Aggiunge i doppi apici " a [field]. I doppi apici rappresentano una stringa in JSON

PUBLISH TOPIC FOR EVENT

Seleziona il formato per i nomi dei topic negli eventi secondo la seguente tabella:

%c	Device Client ID
%m	Device MAC Address
%j[field]	Aggiunge i doppi apici " a [field]. I doppi apici rappresentano una stringa in JSON

PUBLISH PAYLOAD FOR EVENT

Seleziona il formato che deve essere utilizzato per il payload utilizzando la seguente tabella:

%c	Device Client ID
%m	Device MAC Address
%d	data-ora
%t	timestamp (numero di secondi dal 01/01/1970)
%x	testo dell'evento
%j[field]	Aggiunge i doppi apici " a [field]. I doppi apici rappresentano una stringa in JSON

MQTT STATUS

Indica lo stato della comunicazione MQTT con data/ora dell'ultima comunicazione avvenuta con successo.

CA CERTIFICATE FILE (.crt)

File che rappresenta il Root CA Certificate

CLIENT CERTIFICATE FILE (.crt)

File che rappresenta il Client Certificate

CLIENT KEY FILE (.key)

File che rappresenta la chiave del Client

15.8.1. *Esempi:*

Con la seguente configurazione:

CLIENT ID = R203 MQTT Client

PUBLISH TOPIC FOR LOGS = seneca/%c/data

PUBLISH PAYLOAD FOR LOGS = {"t":%jt,"v":[%b]}

PUBLISH BULK FORMAT = {"n":%jn,"v":%jv}

Si otterrà nel topic

seneca/R203 MQTT Client/data

il seguente contenuto:

```
{"t":"1687536452","v":[{"n":"V1N","v":"0.088"},{"n":"V1N_AVG","v":"0.006"},{"n":"V1N_MIN","v":"0.079"},{"n":"V1N_MAX","v":"0.096"},{"n":"V1N_AVG_MIN","v":"0.001"},{"n":"V1N_AVG_MAX","v":"0.089"},{"n":"V2N","v":"0.087"},{"n":"V31_MIN","v":"0.000"},{"n":"V2N_AVG_MIN","v":"0.002"},{"n":"V2N_AVG_MAX","v":"0.090"},{"n":"V3N","v":"0.081"},{"n":"V23_AVG_MAX","v":"0.016"},{"n":"V3N_MIN","v":"0.074"},{"n":"V3N_MAX","v":"0.090"},{"n":"V31_AVG_MAX","v":"0.016"},{"n":"Vsys","v":"0.316"},{"n":"Vsys_AVG","v":"0.016"},{"n":"Vsys_MIN","v":"0.000"},{"n":"Vsys_MAX","v":"0.316"},{"n":"Vsys_AVG_MIN","v":"0.000"}]}
```

Con la seguente configurazione:

MAX FAILURE COUNTER	3	<input type="text" value="3"/>
WAIT AFTER FAILURE (minutes)	30	<input type="text" value="30"/>
CLIENT ID	R203 MQTT Client	<input type="text" value="R203 MQTT Client"/>
BROKER HOST	test.mosquitto.org	<input type="text" value="test.mosquitto.org"/>
BROKER PORT	1883	<input type="text" value="1883"/>
USE WEBSOCKETS	OFF	<input type="button" value="OFF"/>
KEEP ALIVE INTERVAL (seconds)	30	<input type="text" value="30"/>
CLEAN SESSION	OFF	<input type="button" value="OFF"/>
MESSAGE RETAIN	OFF	<input type="button" value="OFF"/>
QUALITY OF SERVICE	QoS 0	<input type="button" value="QoS 0"/>
AUTHENTICATION	OFF	<input type="button" value="OFF"/>
USERNAME	admin	<input type="text" value="admin"/>
PASSWORD	admin	<input type="text" value="admin"/>
SSL/TLS	OFF	<input type="button" value="OFF"/>
CLIENT CERTIFICATE REQUIRED	OFF	<input type="button" value="OFF"/>
CHECK CERTIFICATES	OFF	<input type="button" value="OFF"/>
LOG ON CHANGE	OFF	<input type="button" value="OFF"/>
PUBLISH WITH MULTIPLE TAGS	OFF	<input type="button" value="OFF"/>
PUBLISH TOPIC FOR LOGS	seneca/%c/data	<input type="text" value="seneca/%c/data"/>
PUBLISH PAYLOAD FOR LOGS	{"t":%jt,"v":[%b]}	<input t\":%jt,\"v\":[%b]}"="" type="text" value="{\"/>
PUBLISH BULK FORMAT	{"n":%jn,"v":%jv}	<input n\":%jn,\"v\":%jv}"="" type="text" value="{\"/>
PUBLISH TOPIC FOR EVENT	seneca/%c/event	<input type="text" value="seneca/%c/event"/>
PUBLISH PAYLOAD FOR EVENT	{%x}	<input type="text" value="{%x}"/>
MQTT STATUS	● 07/12/2023 16:36:02	
<input type="button" value="REBOOT"/>	<input type="button" value="FACTORY DEFAULT"/>	<input type="button" value="APPLY"/>

Si otterrà ad esempio:

```
1 - {
2   "t": "1701966872",
3   "v": [
4     {
5       "n": "V31_MIN",
6       "v": "0.000"
7     },
8     {
9       "n": "V2N_AVG_MIN",
10      "v": "0.581"
11    },
12    {
13      "n": "V2N_AVG_MAX",
14      "v": "34.850"
15    },
16    {
17      "n": "V3N",
18      "v": "35.052"
19    },
20    {
21      "n": "V23_AVG_MAX",
22      "v": "0.037"
23    },
24    {
25      "n": "V3N_MIN",
26      "v": "34.611"
27    },
28    {
29      "n": "V3N_MAX",
30      "v": "35.092"
31    },
32    {
33      "n": "V31_AVG_MAX",
34      "v": "0.352"
35    },
36    {
37      "n": "Vsys",
38      "v": "2.145"
39    },
40    {
41      "n": "Vsys_AVG",
42      "v": "0.250"
43    },
44    {
```

Con la seguente configurazione:

	CURRENT	UPDATED
NOTE: Log Publish Period is given by "DATA LOGGER SAMPLE TIME" parameter (see page "Setup Datalogger").		
MAX FAILURE COUNTER	3	<input type="text" value="3"/>
WAIT AFTER FAILURE (minutes)	30	<input type="text" value="30"/>
CLIENT ID	R203 MQTT Client	<input type="text" value="R203 MQTT Client"/>
BROKER HOST	test.mosquitto.org	<input type="text" value="test.mosquitto.org"/>
BROKER PORT	1883	<input type="text" value="1883"/>
USE WEBSOCKETS	OFF	<input type="text" value="OFF"/>
KEEP ALIVE INTERVAL (seconds)	30	<input type="text" value="30"/>
CLEAN SESSION	OFF	<input type="text" value="OFF"/>
MESSAGE RETAIN	OFF	<input type="text" value="OFF"/>
QUALITY OF SERVICE	QoS 0	<input type="text" value="QoS 0"/>
AUTHENTICATION	OFF	<input type="text" value="OFF"/>
USERNAME	admin	<input type="text" value="admin"/>
PASSWORD	admin	<input type="text" value="admin"/>
SSL/TLS	OFF	<input type="text" value="OFF"/>
CLIENT CERTIFICATE REQUIRED	OFF	<input type="text" value="OFF"/>
CHECK CERTIFICATES	OFF	<input type="text" value="OFF"/>
LOG ON CHANGE	OFF	<input type="text" value="OFF"/>
PUBLISH WITH MULTIPLE TAGS	ON	<input type="text" value="ON"/>
PUBLISH TOPIC FOR LOGS	seneca/%c/data	<input type="text" value="seneca/%c/data"/>
PUBLISH PAYLOAD FOR LOGS	{"n":%jn,"v":%jv}	<input n\":%jn,\"v\":%jv}"="" type="text" value="{\"/>
PUBLISH BULK FORMAT	{"n":%jn,"v":%jv}	<input n\":%jn,\"v\":%jv}"="" type="text" value="{\"/>
PUBLISH TOPIC FOR EVENT	seneca/%c/event	<input type="text" value="seneca/%c/event"/>
PUBLISH PAYLOAD FOR EVENT	{%x}	<input type="text" value="{%x}"/>
MQTT STATUS	● 07/12/2023 16:38:16	
REBOOT	FACTORY DEFAULT	APPLY

Si noti il parametro "PUBLISH PAYLOAD FOR LOGS", invierà tutta una serie di pacchetti del tipo:

```
1 - {  
2   "n": "Vsys_AVG_MIN",  
3   "v": "0.000"  
4 }
```

15.9. SEZIONE HTTP CONFIGURATION (SOLO MODELLI R203)

MAX FAILURE COUNTER

Numero Massimo di errori prima di attendere il tempo del parametro "WAIT AFTER FAILURE"

WAIT AFTER FAILURE (minutes)

Tempo di attesa prima di tentare una nuova connessione

SSL/TLS

Definisce se attivare il protocollo criptato di sicurezza SSL/TLS 1.2

HOST

Definisce l'host name del server

PORT

Definisce la porta del server http

AUTHENTICATION

Questo parametro definisce se deve essere utilizzata l'autenticazione con utente / password per l'accesso al server http

USERNAME

Username del server http

PASSWORD

Password del server http

LOG ON CHANGE

Aggiorna i valori sul server solo su cambiamento

HYSTERESIS

Valore di isteresi per I dati analogici da inviare con la funzione "Log on change"

PUBLISH WITH MULTIPLE TAGS

Questo parametro definisce se la post contiene più tag o se il dispositivo deve inviare una post per ciascun tag

PUBLISH PAYLOAD FOR LOGS

Seleziona il formato che deve essere utilizzato per il payload utilizzando la seguente tabella:

%m	Device MAC Address
%t	timestamp (numero di secondi dal 01/01/1970)
%tms	timestamp (numero di millisecondi dal 01/01/1970)
%b	bulk (formato specificato in "Publish Bulk Format")
%i	Id univoco della variabile (solo per "Publish Bulk Format")
%n	Nome del tag (solo per "Publish Bulk Format")
%v	Valore del tag (solo in "Publish Bulk Format")
%j[field]	Aggiunge i doppi apici " a [field]. I doppi apici rappresentano una stringa in JSON

PUBLISH BULK FORMAT

Seleziona il formato per il "bulk mode" secondo la seguente tabella:

%c	Device Client ID
%m	Device MAC Address
%d	Data/ora
%t	timestamp (numero di secondi dal 01/01/1970)
%tms	timestamp (numero di millisecondi dal 01/01/1970)
%i	Id univoco della variabile (solo per "Publish Bulk Format")
%n	Nome del tag (solo per "Publish Bulk Format")
%v	Valore del tag (solo in "Publish Bulk Format")
%j[field]	Aggiunge i doppi apici " a [field]. I doppi apici rappresentano una stringa in JSON

Nota: il placeholder %i aggiunge un ID univoco alla variabile da pubblicare secondo la seguente tabella:

%i (ID)	VARIABLE
1	V1N
2	V1N_AVG
3	V1N_MIN
4	V1N_MAX
5	V1N_AVG_MIN
6	V1N_AVG_MAX
7	V2N
8	V2N_AVG
9	V2N_MIN

10	V2N_MAX
11	V2N_AVG_MIN
12	V2N_AVG_MAX
13	V3N
14	V3N_AVG
15	V3N_MIN
16	V3N_MAX
17	V3N_AVG_MIN
18	V3N_AVG_MAX
19	AN
20	AN_AVG
21	AN_MIN
22	AN_MAX
23	AN_AVG_MIN
24	AN_AVG_MAX
25	V12
26	V12_AVG
27	V12_MIN
28	V12_MAX
29	V12_AVG_MIN
30	V12_AVG_MAX
31	V23
32	V23_AVG
33	V23_MIN
34	V23_MAX
35	V23_AVG_MIN
36	V23_AVG_MAX
37	V31
38	V31_AVG
39	V31_MIN
40	V31_MAX
41	V31_AVG_MIN
42	V31_AVG_MAX
43	Vsys
44	Vsys_AVG
45	Vsys_MIN
46	Vsys_MAX
47	Vsys_AVG_MIN
48	Vsys_AVG_MAX
49	A1
50	A1_AVG
51	A1_MIN
52	A1_MAX

53	A1_AVG_MIN
54	A1_AVG_MAX
55	A2
56	A2_AVG
57	A2_MIN
58	A2_MAX
59	A2_AVG_MIN
60	A2_AVG_MAX
61	A3
62	A3_AVG
63	A3_MIN
64	A3_MAX
65	A3_AVG_MIN
66	A3_AVG_MAX
67	Asys
68	Asys_AVG
69	Asys_MIN
70	Asys_MAX
71	Asys_AVG_MIN
72	Asys_AVG_MAX
73	P1
74	P1_AVG
75	P1_MIN
76	P1_MAX
77	P1_AVG_MIN
78	P1_AVG_MAX
79	P2
80	P2_AVG
81	P2_MIN
82	P2_MAX
83	P2_AVG_MIN
84	P2_AVG_MAX
85	P3
86	P3_AVG
87	P3_MIN
88	P3_MAX
89	P3_AVG_MIN
90	P3_AVG_MAX
91	Psys
92	Psys_AVG
93	Psys_MIN
94	Psys_MAX
95	Psys_AVG_MIN

96	Psys_AVG_MAX
97	S1
98	S1_AVG
99	S1_MIN
100	S1_MAX
101	S1_AVG_MIN
102	S1_AVG_MAX
103	S2
104	S2_AVG
105	S2_MIN
106	S2_MAX
107	S2_AVG_MIN
108	S2_AVG_MAX
109	S3
110	S3_AVG
111	S3_MIN
112	S3_MAX
113	S3_AVG_MIN
114	S3_AVG_MAX
115	Ssys
116	Ssys_AVG
117	Ssys_MIN
118	Ssys_MAX
119	Ssys_AVG_MIN
120	Ssys_AVG_MAX
121	Q1
122	Q1_AVG
123	Q1_MIN
124	Q1_MAX
125	Q1_AVG_MIN
126	Q1_AVG_MAX
127	Q2
128	Q2_AVG
129	Q2_MIN
130	Q2_MAX
131	Q2_AVG_MIN
132	Q2_AVG_MAX
133	Q3
134	Q3_AVG
135	Q3_MIN
136	Q3_MAX
137	Q3_AVG_MIN
138	Q3_AVG_MAX

139	Qsys
140	Qsys_AVG
141	Qsys_MIN
142	Qsys_MAX
143	Qsys_AVG_MIN
144	Qsys_AVG_MAX
145	TPF1
146	TPF1_AVG
147	TPF1_MIN
148	TPF1_MAX
149	TPF1_AVG_MIN
150	TPF1_AVG_MAX
151	TPF2
152	TPF2_AVG
153	TPF2_MIN
154	TPF2_MAX
155	TPF2_AVG_MIN
156	TPF2_AVG_MAX
157	TPF3
158	TPF3_AVG
159	TPF3_MIN
160	TPF3_MAX
161	TPF3_AVG_MIN
162	TPF3_AVG_MAX
163	TPFsys
164	TPFsys_AVG
165	TPFsys_MIN
166	TPFsys_MAX
167	TPFsys_AVG_MIN
168	TPFsys_AVG_MAX
169	THD-V1N
170	THD-V1N_AVG
171	THD-V1N_MIN
172	THD-V1N_MAX
173	THD-V1N_AVG_MIN
174	THD-V1N_AVG_MAX
175	THD-V2N
176	THD-V2N_AVG
177	THD-V2N_MIN
178	THD-V2N_MAX
179	THD-V2N_AVG_MIN
180	THD-V2N_AVG_MAX
181	THD-V3N

182	THD-V3N_AVG
183	THD-V3N_MIN
184	THD-V3N_MAX
185	THD-V3N_AVG_MIN
186	THD-V3N_AVG_MAX
187	f
188	THD-A1N
189	THD-A1N_AVG
190	THD-A1N_MIN
191	THD-A1N_MAX
192	THD-A1N_AVG_MIN
193	THD-A1N_AVG_MAX
194	THD-A2N
195	THD-A2N_AVG
196	THD-A2N_MIN
197	THD-A2N_MAX
198	THD-A2N_AVG_MIN
199	THD-A2N_AVG_MAX
200	THD-A3N
201	THD-A3N_AVG
202	THD-A3N_MIN
203	THD-A3N_MAX
204	THD-A3N_AVG_MIN
205	THD-A3N_AVG_MAX
206	+WH1
207	+WH2
208	+WH3
209	+Wh
210	-WH1
211	-WH2
212	-WH3
213	-Wh
214	VAh1
215	VAh2
216	VAh3
217	VAh
218	+VARh1-L[Q1]
219	+VARh2-L[Q1]
220	+VARh3-L[Q1]
221	+VARh-L[Q1]
222	-VARh1-C[Q4]
223	-VARh2-C[Q4]
224	-VARh3-C[Q4]

225	-VARh-C[Q4]
226	-VARh1-L[Q3]
227	-VARh2-L[Q3]
228	-VARh3-L[Q3]
229	-VARh-L[Q3]
230	+VARh1-C[Q2]
231	+VARh2-C[Q2]
232	+VARh3-C[Q2]
233	+VARh-C[Q2]
234	Wh
235	VARh
236	VARh-L[Q1Q3]
237	VARh-C[Q2Q4]
238	VAh
239	COUNTER 1
240	COUNTER 2
241	DIGITAL_IN_1
242	DIGITAL_IN_2
243	DIGITAL_OUT_1
244	DIGITAL_OUT_2

PUBLISH PAYLOAD FOR EVENT

Seleziona il formato che deve essere utilizzato per il payload utilizzando la seguente tabella:

%c	Device Client ID
%m	Device MAC Address
%d	data-ora
%t	timestamp (numero di secondi dal 01/01/1970)
%x	testo dell'evento
%j[field]	Aggiunge i doppi apici " a [field]. I doppi apici rappresentano una stringa in JSON

HTTP STATUS

Indica lo stato della comunicazione HTTP con data/ora dell'ultima comunicazione avvenuta con successo.

16. DOWNLOAD DEI FILE DEL DATALOGGER (SOLO MODELLI R203)

Nella sezione "Datalogger view" è possibile scaricare l'intero database a tempo in formato testo csv.
Nella sezione "Datalogger event view" è possibile Scaricare l'intero database eventi in formato testo csv.

ATTENZIONE!

I FILE DI TESTO SCARICATI DAL DATALOGGER HANNO ESTENSIONE DI DEFAULT .CGI. PER UTILIZZARLI IN SOFTWARE TIPO "EXCEL" È POSSIBILI RINOMINARLI IN .CSV

17. MODBUS PASSTROUGH (SOLO MODELLI R203)

Grazie alla funzione Modbus Passthrough è possibile estendere la quantità di I/O a disposizione nel dispositivo tramite la porta RS485 ed il protocollo Modbus RTU slave ad esempio utilizzando i prodotti della serie Z-PC Seneca.

In questa modalità la porta RS485 smette di funzionare come Modbus RTU slave e il dispositivo diventa un gateway Modbus TCP-IP to Modbus RTU seriale:

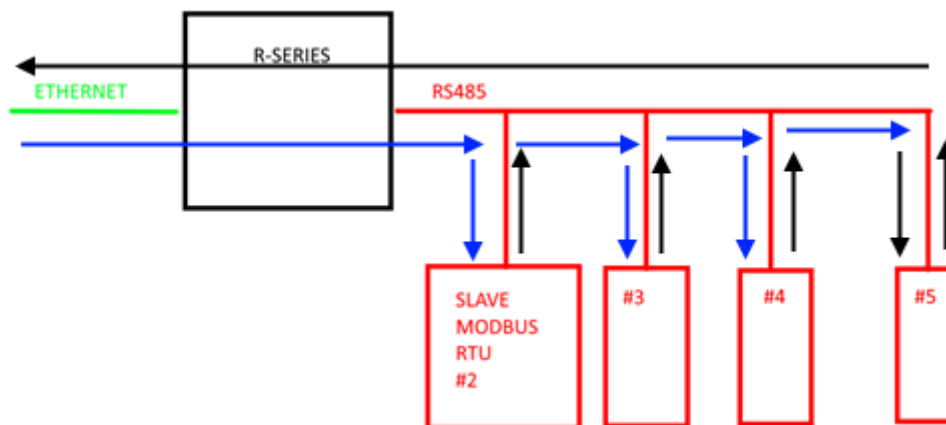

Ogni richiesta Modbus TCP-IP con station address diverso da quello del dispositivo della serie R viene convertito in pacchetto seriale sulla RS485 e, nel caso di risposta, viene rigirato su TCP-IP.

Non è più necessario, quindi, acquistare gateway per estendere il numero di I/O o per connettere I/O Modbus RTU già disponibile.

18. AGGIORNAMENTO DEL FIRMWARE

Nella sezione "Update" del Webserver è possibile aggiornare il firmware tramite un file binario che può essere scaricato direttamente dal sito Seneca nella sezione download del dispositivo.

19. PROTOCOLLO DI COMUNICAZIONE MODBUS (SOLO MODELLI R203)

Il protocollo di comunicazione supportato è:

- Modbus RTU Slave (dalla porta RS485)
- Modbus TCP-IP Server (dalle porte ethernet)

Il Modbus TCP-IP Server supporta fino a 8 client contemporanei.

Per ulteriori informazioni su questi protocolli, consultare il sito Web:

<http://www.modbus.org/specs.php>.

19.1. CODICI FUNZIONE MODBUS SUPPORTATI

Sono supportate le seguenti funzioni Modbus:

- Read Holding Register (function 3)
- Write Single Register (function 6)
- Write Multiple registers (function 16)

ATTENZIONE!

Tutti i valori a 32 bit sono contenuti in 2 registri consecutivi

ATTENZIONE!

Tutti i valori a 64 bit sono contenuti in 4 registri consecutivi

ATTENZIONE!

Eventuali registri con RW* (contenuti in memoria flash) possono essere scritti un massimo di circa
10000 volte

Deve essere cura del programmatore PLC / Master Modbus non superare questo limite

19.2. TAVOLA DEI REGISTRI MODBUS

Nelle tavole dei registri sono usate le seguenti abbreviazioni:

MS = Più significativo
LS = Meno significativo
MSW = Parola più significativa (16bit)
LSW = Parola meno significativa (16bit)
MMSW = Parola più "più" significativa (16bit)
LLSW = Parola meno "meno" significativa (16bit)
MSB = 8 bit più significativi
LSB = 8 bit meno significativi
MSBIT = Bit più significativo
LSBIT = Bit meno significativo
RO = Registro in sola lettura
RW = Registro in lettura/scrittura
RW** = Registro in lettura e scrittura contenuto in memoria flash, scrivibile un massimo di 10000 volte.
Unsigned 16 bit = Registro intero senza segno, può assumere valori da 0 a 65535
Signed 16 bit = Registro intero con segno può assumere valori da -32768 a +32767
Float 32 bit = Registro floating point a singola precisione a 32 bit (IEEE 754) https://en.wikipedia.org/wiki/IEEE_754
BIT = Registro booleano, può valere 0 (false) o 1 (true)

19.3. NUMERAZIONE DEGLI INDIRIZZI MODBUS "0 BASED" O "1 BASED"

I registri Holding Register secondo lo standard Modbus sono indirizzabili da 0 a 65535, esistono 2 diverse convenzioni per la numerazione degli indirizzi: la "0 BASED" e la "1 BASED".

Per maggiore chiarezza Seneca riporta le proprie tabelle dei registri in entrambe le convenzioni.



ATTENZIONE!

LEGGERE ATTENTAMENTE LA DOCUMENTAZIONE DEL DISPOSITIVO MASTER MODBUS AL FINE DI CAPIRE QUALE DELLE DUE CONVENZIONI IL COSTRUTTORE HA DECISO DI UTILIZZARE.

19.4. NUMERAZIONE DEGLI INDIRIZZI MODBUS CON CONVENZIONE "0 BASED"

La numerazione è del tipo:

INDIRIZZO MODBUS HOLDING REGISTER (OFFSET)	SIGNIFICATO
0	PRIMO REGISTRO
1	SECONDO REGISTRO
2	TERZO REGISTRO
3	QUARTO REGISTRO
4	QUINTO REGISTRO

Per cui il primo registro si trova all'indirizzo 0.

Nelle tabelle che seguono questa convenzione è indicata con "**OFFSET INDIRIZZO**".

19.5. NUMERAZIONE DEGLI INDIRIZZI MODBUS CON CONVENZIONE "1 BASED" (STANDARD)

La numerazione è quella stabilita dal consorzio Modbus ed è del tipo:

INDIRIZZO MODBUS HOLDING REGISTER 4x	SIGNIFICATO
40001	PRIMO REGISTRO
40002	SECONDO REGISTRO
40003	TERZO REGISTRO
40004	QUARTO REGISTRO
40005	QUINTO REGISTRO

Nelle tabelle che seguono questa convenzione è indicata con "**INDIRIZZO 4x**" poiché viene aggiunto un 4 all'indirizzo in modo che il primo registro Modbus sia 40001.

È anche possibile una ulteriore convenzione dove viene omissso il numero 4 davanti all'indirizzo del registro:

INDIRIZZO MODBUS HOLDING SENZA 4x	SIGNIFICATO
1	PRIMO REGISTRO
2	SECONDO REGISTRO
3	TERZO REGISTRO
4	QUARTO REGISTRO
5	QUINTO REGISTRO

19.6. CONVENZIONE DEI BIT ALL'INTERNO DI UN REGISTRO MODBUS HOLDING REGISTER

Un registro Modbus Holding Register è composto da 16 bit con la seguente convenzione:

BIT 15	BIT 14	BIT 13	BIT 12	BIT 11	BIT 10	BIT 9	BIT 8	BIT 7	BIT 6	BIT 5	BIT 4	BIT 3	BIT 2	BIT 1	BIT 0
-----------	-----------	-----------	-----------	-----------	-----------	----------	----------	----------	----------	----------	----------	----------	----------	----------	----------

Ad esempio, se il valore del registro in decimale è
12300

il valore 12300 in esadecimale vale:

0x300C

l'esadecimale 0x300C in valore binario vale:

11 0000 0000 1100

Quindi, usando la convenzione di cui sopra otteniamo:

BIT 15	BIT 14	BIT 13	BIT 12	BIT 11	BIT 10	BIT 9	BIT 8	BIT 7	BIT 6	BIT 5	BIT 4	BIT 3	BIT 2	BIT 1	BIT 0
0	0	1	1	0	0	0	0	0	0	0	0	1	1	0	0

19.7. CONVENZIONE DEI BYTE MSB e LSB ALL'INTERNO DI UN REGISTRO MODBUS HOLDING REGISTER

Un registro Modbus Holding Register è composto da 16 bit con la seguente convenzione:

BIT 15	BIT 14	BIT 13	BIT 12	BIT 11	BIT 10	BIT 9	BIT 8	BIT 7	BIT 6	BIT 5	BIT 4	BIT 3	BIT 2	BIT 1	BIT 0
-----------	-----------	-----------	-----------	-----------	-----------	----------	----------	----------	----------	----------	----------	----------	----------	----------	----------

Si definisce Byte LSB (Least Significant Byte) gli 8 bit che vanno da Bit 0 a Bit 7 compresi, si definisce Byte MSB (Most Significant Byte) gli 8 bit che vanno da Bit 8 a Bit 15 compresi:

BIT 15	BIT 14	BIT 13	BIT 12	BIT 11	BIT 10	BIT 9	BIT 8	BIT 7	BIT 6	BIT 5	BIT 4	BIT 3	BIT 2	BIT 1	BIT 0
BYTE MSB								BYTE LSB							

19.8. RAPPRESENTAZIONE DI UN VALORE A 32 BIT IN DUE REGISTRI MODBUS HOLDING REGISTER CONSECUTIVI

La rappresentazione di un valore a 32 bit nei registri Holding Register in Modbus è fatta utilizzando 2 registri consecutivi Holding Register (un registro Holding Register è da 16 bit). Per ottenere il valore a 32 bit è necessario leggere quindi due registri consecutivi:

Ad esempio se il registro 40064 contiene i 16 bit più significativi (MSW) mentre il registro 40065 i 16 bit meno significativi (LSW) il valore a 32 bit si ottiene componendo i 2 registri:

BIT	BIT	BIT	BIT	BIT	BIT	BIT	BIT	BIT	BIT	BIT	BIT	BIT	BIT	BIT	BIT
15	14	13	12	11	10	9	8	7	6	5	4	3	2	1	0
40064 MOST SIGNIFICANT WORD															

BIT	BIT	BIT	BIT	BIT	BIT	BIT	BIT	BIT	BIT	BIT	BIT	BIT	BIT	BIT	BIT
15	14	13	12	11	10	9	8	7	6	5	4	3	2	1	0
40065 LEAST SIGNIFICANT WORD															

$$Value_{32bit} = Register_{LSW} + (Register_{MSW} * 65536)$$

Nei registri di lettura è possibile scambiare il word più significativo con quello meno significativo quindi è possibile ottenere il 40064 come LSW e il 40065 come MSW.

19.9. TIPI DI DATO FLOATING POINT A 32 BIT (IEEE 754)

Lo standard IEEE 754 (https://en.wikipedia.org/wiki/IEEE_754) definisce il formato per la rappresentazione dei numeri in virgola mobile.

Come già detto poiché si tratta di un tipo dati a 32 bit la sua rappresentazione occupa due registri holding register da 16 bit.

Per ottenere una conversione binaria / esadecimale di un valore floating point si può fare riferimento ad un convertitore online a questo indirizzo:

<http://www.h-schmidt.net/FloatConverter/IEEE754.html>

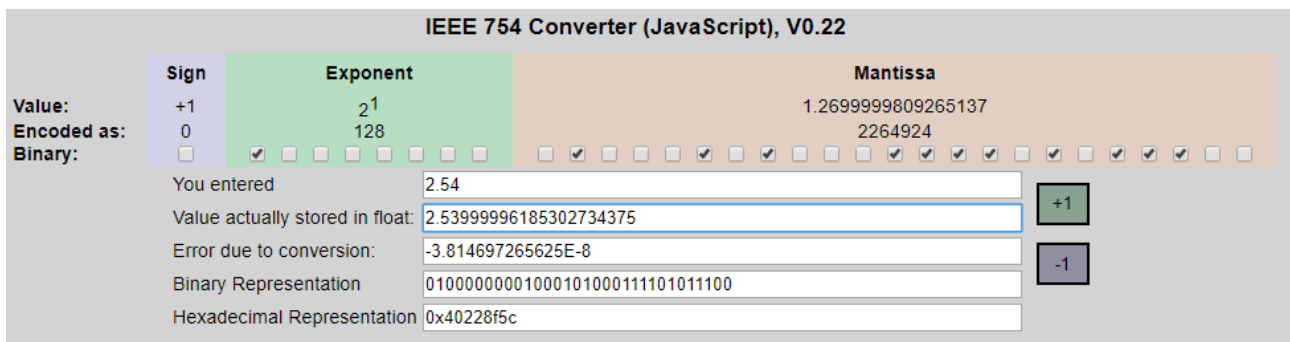

The screenshot shows the IEEE 754 Converter interface. It displays the following information:

- Value:** 2.54
- Encoded as:** 0
- Binary:** 01000000001000101000111101011100
- Hexadecimal Representation:** 0x40228f5c
- Sign:** +1
- Exponent:** 2¹ (128)
- Mantissa:** 1.2699999809265137 (2264924)
- Value actually stored in float:** 2.53999996185302734375
- Error due to conversion:** -3.814697265625E-8

Utilizzando l'ultima rappresentazione il valore 2.54 è rappresentato a 32 bit come:

0x40228F5C

Poiché abbiamo a disposizione registri a 16 bit il valore va diviso in MSW e LSW:

0x4022 (16418 decimale) sono i 16 bit più significativi (MSW) mentre 0x8F5C (36700 decimale) sono i 16 bit meno significativi (LSW).

19.10. TAVOLA DEI REGISTRI MODBUS 4x HOLDING REGISTERS (FUNCTION CODE 3)

ADDRESS (4x)	ADDRESS OFFSET	REGISTER	PHASE	DESCRIPTION	W/R	TYPE
40001	0	MACHINE-ID	-	Device ID	RO	UNSIGNED 16BIT
40002	1	FW REVISION (Maior/Minor)	-	FW revision	RO	UNSIGNED 16BIT
40003	2	FW REVISION (Fix/Build)	-	FW revision	RO	UNSIGNED 16BIT
40004	3	FW CODE	-	FW code	RO	UNSIGNED 16BIT
40005	4	FW RESERVED	-	-	RO	UNSIGNED 16BIT
40006	5	FW RESERVED	-	-	RO	UNSIGNED 16BIT
40007	6	BOARD-ID	-	HW revision	RO	UNSIGNED 16BIT
40008	7	BOOT REVISION (Maior/Minor)	-	FW Bootloader revision	RO	UNSIGNED 16BIT
40009	8	BOOT REVISION (Fix/Build)	-	FW Bootloader revision	RO	UNSIGNED 16BIT
40010	9	BOOT CODE	-	Bootloader FW code	RO	UNSIGNED 16BIT
40011	10	RESERVED	-	-	RO	UNSIGNED 16BIT
40012	11	RESERVED	-	-	RO	UNSIGNED 16BIT
40013	12	COMMAND AUX 3H	-	COMMAND REGISTER 3	RW	UNSIGNED 16BIT
40014	13	COMMAND AUX 3L	-		RW	UNSIGNED 16BIT
40015	14	COMMAND AUX 2	-	COMMAND REGISTER 2	RW	UNSIGNED 16BIT
40016	15	COMMAND AUX 1	-		RW	UNSIGNED 16BIT
40017	16	COMMAND	-	Supported command list: 49568 decimal to perform a Reboot	RW	UNSIGNED 16BIT
40018	17	STATUS	-	BIT0 -> Cyclic phase sense error (1 ERR, 0 OK)	RW	UNSIGNED 16BIT

ADDRESS (4x)	ADDRESS OFFSET	REGISTER	PHASE	DESCRIPTION	W/R	TYPE
				BIT1 -> ALARM (1 ACTIVE, 0 NOT ACTIVE) BIT2 -> DOUT1 status (1 ACTIVE, 0 NOT ACTIVE) BIT3 -> DOUT2 status (1 ACTIVE, 0 NOT ACTIVE) BIT4 -> DIN1 STATUS (1 high, 0 low) BIT5 -> DIN2 STATUS (1 high, 0 low) BIT6 -> Current Cutoff (1 active, 0 inactive) BIT 7 -> Current error L1 (1 CT connected reverse, 0 CT connected OK) BIT 8 -> Current error L2 (1 CT connected reverse, 0 CT connected OK) BIT 9 -> Current error L3 (1 CT connected inverted, 0 CT connected OK) BIT 10 -> Line 1 Voltage/Current connection error (1 Error, 0 OK) BIT 11 -> Connection error Line 2 Voltage/Current (1 Error, 0 OK) BIT 12 -> Connection error Line 3 Voltage/Current (1 Error, 0 OK)		
40019	18	RESERVED	-	-	RW	UNSIGNED 16BIT
40020	19	RESERVED	-	-	RW	UNSIGNED 16BIT
40021	20	RESERVED	-	-	RW	UNSIGNED 16BIT
40022	21	INPUT VALUES	-	Status of digital inputs 1 and 2 Bit[0] = INPUT1 Bit[1] = INPUT2	RW	UNSIGNED 16BIT

ADDRESS (4x)	ADDRESS OFFSET	REGISTER	PHASE	DESCRIPTION	W/R	TYPE
40023	22	Output	-	Status of digital outputs Bit[0] = OUTPUT1 Bit[1] = OUTPUT2	RW	UNSIGNED 16BIT
40024	23	RESERVED	-	-	RW	UNSIGNED 16BIT
40025	24	RESERVED	-	-	RW	UNSIGNED 16BIT
40026	25	RESERVED	-	-	RW	UNSIGNED 16BIT
40027	26	ANALOG OUTPUT MANUAL	-	When the analogue output is in pilot "manual" mode the output 0=0% 8190=100%	RW	UNSIGNED 16BIT
40101	100	V RMS [V] MSW	L1-L2	RMS phase-to-phase voltage measurement in [V] (Set to 0 if Aron insertion is used)	RO	FLOAT32
40102	101	V RMS [V] LSW			RO	
40103	102	V RMS [V] MSW	L2-L3	RMS phase-to-phase voltage measurement in [V] (Set to 0 if Aron insertion is used)	RO	FLOAT32
40104	103	V RMS [V] LSW			RO	
40105	104	V RMS [V] MSW	L3-L1	RMS phase-to-phase voltage measurement in [V] (Set to 0 if Aron insertion is used)	RO	FLOAT32
40106	105	V RMS [V] LSW			RO	
40107	106	I RMS [A] MSW	L1	RMS current measurement in [A]	RO	FLOAT32
40108	107	I RMS [A] LSW			RO	
40109	108	I RMS [A] MSW	L2	RMS current measurement in [A]	RO	FLOAT32
40110	109	I RMS [A] LSW			RO	
40111	110	I RMS [A] MSW	L3	RMS current measurement in [A]	RO	FLOAT32
40112	111	I RMS [A] LSW			RO	
40113	112	I RMS [A] MSW	N	RMS current measurement in [A]	RO	FLOAT32
40114	113	I RMS [A] LSW			RO	
40115	114	V-I PHASE [°] MSW	L1	Measurement of the angle in [°] between Voltage and Current	RO	FLOAT32
40116	115	V-I PHASE [°] LSW			RO	
40117	116	V-I PHASE [°] MSW	L2	Measurement of the angle in [°] between Voltage and Current	RO	FLOAT32
40118	117	V-I PHASE [°] LSW			RO	
40119	118	V-I PHASE [°] MSW	L3	Measurement of the angle in [°] between Voltage and Current	RO	FLOAT32
40120	119	V-I PHASE [°] LSW			RO	

ADDRESS (4x)	ADDRESS OFFSET	REGISTER	PHASE	DESCRIPTION	W/R	TYPE
40121	120	P ACTIVE POWER [W] MSW	L1	Phase Active Power measurement in [W] "+" sign = Absorbed Active Power "-" sign = Generated Active Power	RO	FLOAT32
40122	121	P ACTIVE POWER [W] LSW			RO	
40123	122	P ACTIVE POWER [W] MSW	L2	Phase Active Power measurement in [W] "+" sign = Absorbed Active Power "-" sign = Generated Active Power	RO	FLOAT32
40124	123	P ACTIVE POWER [W] LSW			RO	
40125	124	P ACTIVE POWER [W] MSW	L3	Phase Active Power measurement in [W] "+" sign = Absorbed Active Power "-" sign = Generated Active Power	RO	FLOAT32
40126	125	P ACTIVE POWER [W] LSW			RO	
40127	126	Q REACTIVE POWER [VAR] MSW	L1	Phase Reactive Power measurement in [VAR]	RO	FLOAT32
40128	127	Q REACTIVE POWER [VAR] LSW			RO	
40129	128	Q REACTIVE POWER [VAR] MSW	L2	Phase Reactive Power measurement in [VAR]	RO	FLOAT32
40130	129	Q REACTIVE POWER [VAR] LSW			RO	
40131	130	Q REACTIVE POWER [VAR] MSW	L3	Phase Reactive Power measurement in [VAR]	RO	FLOAT32
40132	131	Q REACTIVE POWER [VAR] LSW			RO	
40133	132	S APPARENT POWER [VA] MSW	L1	Phase Apparent Power measurement in [VA]	RO	FLOAT32
40134	133	S APPARENT POWER [VA] LSW			RO	
40135	134	S APPARENT POWER [VA] MSW	L2	Phase Apparent Power measurement in [VA]	RO	FLOAT32
40136	135	S APPARENT POWER [VA] LSW			RO	
40137	136	S APPARENT POWER [VA] MSW	L3	Phase Apparent Power measurement in [VA]	RO	FLOAT32
40138	137	S APPARENT POWER [VA] LSW			RO	
40139	138	PF POWER FACTOR MSW	L1	Phase power factor measurement "+" sign = User "-" sign = Generator	RO	FLOAT32
40140	139	PF POWER FACTOR LSW			RO	
40141	140	PF POWER FACTOR MSW	L2	Phase power factor measurement "+" sign = User "-" sign = Generator	RO	FLOAT32
40142	141	PF POWER FACTOR LSW			RO	
40143	142	PF POWER FACTOR MSW	L3	Phase power factor measurement "+" sign = User "-" sign = Generator	RO	FLOAT32
40144	143	PF POWER FACTOR LSW			RO	
40145	144	F FREQUENCY [HZ] MSW	L1	Phase frequency measurement in [Hz]	RO	FLOAT32
40146	145	F FREQUENCY [HZ] LSW			RO	

ADDRESS (4x)	ADDRESS OFFSET	REGISTER	PHASE	DESCRIPTION	W/R	TYPE
40147	146	F FREQUENCY [HZ] MSW	L2	Phase frequency measurement in [Hz]	RO	FLOAT32
40148	147	F FREQUENCY [HZ] LSW			RO	
40149	148	F FREQUENCY [HZ] MSW	L3	Phase frequency measurement in [Hz]	RO	FLOAT32
40150	149	F FREQUENCY [HZ] LSW			RO	
40151	150	PERIOD [s] MSW	L1	Phase period measurement in [s]	RO	FLOAT32
40152	151	PERIOD [s] LSW			RO	
40153	152	PERIOD [s] MSW	L2	Phase period measurement in [s]	RO	FLOAT32
40154	153	PERIOD [s] LSW			RO	
40155	154	PERIOD [s] MSW	L3	Phase period measurement in [s]	RO	FLOAT32
40156	155	PERIOD [s] LSW			RO	
40157	156	V-V PHASE [°] MSW	L1-L2	Measurement of the angle in [°] between Voltage and Voltage	RO	FLOAT32
40158	157	V-V PHASE [°] LSW			RO	
40159	158	V-V PHASE [°] MSW	L2-L3	Measurement of the angle in [°] between Voltage and Voltage	RO	FLOAT32
40160	159	V-V PHASE [°] LSW			RO	
40161	160	V-V PHASE [°] MSW	L3-L1	Measurement of the angle in [°] between Voltage and Voltage	RO	FLOAT32
40162	161	V-V PHASE [°] LSW			RO	
40163	162	VLN rms [V] MSW	L1-N	Phase-neutral star voltage measurement (if Aron insertion is used, VL1N = V12)	RO	FLOAT32
40164	163	VLN rms [V] LSW			RO	
40165	164	VLN rms [V] MSW	L2-N	Phase-neutral star voltage measurement (if Aron insertion is used, VL2N = VL1N = V12)	RO	FLOAT32
40166	165	VLN rms [V] LSW			RO	
40167	166	VLN rms [V] MSW	L3-N	Phase-neutral star voltage measurement (if Aron insertion is used, VL3N = V32)	RO	FLOAT32
40168	167	VLN rms [V] LSW			RO	
40169	168	P TOTAL [W] MSW	3PH	Total Active Power measurement in [W] "+" sign = Absorbed Active Power "-" sign = Generated Active Power	RO	FLOAT32
40170	169	P TOTAL [W] LSW			RO	
40171	170	Q TOTAL [VAR] MSW	3PH	Total Reactive Power measurement in [VAR]	RO	FLOAT32
40172	171	Q TOTAL [VAR] LSW			RO	
40173	172	S TOTAL [VA] MSW	3PH	Total Apparent Power measurement in [VA]	RO	FLOAT32
40174	173	S TOTAL [VA] LSW			RO	
40175	174	PF TOTAL MSW	3PH	Total power factor measurement "+" sign = User "-" sign = Generator	RO	FLOAT32
40176	175	PF TOTAL LSW			RO	

ADDRESS (4x)	ADDRESS OFFSET	REGISTER	PHASE	DESCRIPTION	W/R	TYPE
40177	176	THD V [%] MSW	L1	Measurement of the total voltage harmonic distortion in [%] in comparison with the fundamental	RO	FLOAT32
40178	177	THD V [%] LSW			RO	
40179	178	THD V [%] MSW	L2	Measurement of the total voltage harmonic distortion in [%] in comparison with the fundamental	RO	FLOAT32
40180	179	THD V [%] LSW			RO	
40181	180	THD V [%] MSW	L3	Measurement of the total voltage harmonic distortion in [%] in comparison with the fundamental	RO	FLOAT32
40182	181	THD V [%] LSW			RO	
40183	182	THD I [%] MSW	L1	Measurement of the total current harmonic distortion in [%] in comparison with the fundamental	RO	FLOAT32
40184	183	THD I [%] LSW			RO	
40185	184	THD I [%] MSW	L2	Measurement of the total current harmonic distortion in [%] in comparison with the fundamental	RO	FLOAT32
40186	185	THD I [%] LSW			RO	
40187	186	THD I [%] MSW	L3	Measurement of the total current harmonic distortion in [%] in comparison with the fundamental	RO	FLOAT32
40188	187	THD I [%] LSW			RO	
40189	188	VRMS FUNDAMENTAL [V] MSW	L1-N	Measurement of the Phase - Neutral VRMS of the fundamental alone [V]	RO	FLOAT32
40190	189	VRMS FUNDAMENTAL [V] LSW			RO	
40191	190	VRMS FUNDAMENTAL [V] MSW	L2-N	Measurement of the Phase - Neutral VRMS of the fundamental alone [V]	RO	FLOAT32
40192	191	VRMS FUNDAMENTAL [V] LSW			RO	
40193	192	VRMS FUNDAMENTAL [V] MSW	L3-N	Measurement of the Phase - Neutral VRMS of the fundamental alone [V]	RO	FLOAT32
40194	193	VRMS FUNDAMENTAL [V] LSW			RO	
40195	194	VRMS HARMONIC 2 [V] MSW	L1-N	Measurement of the Phase - Neutral VRMS of the i-th harmonic [V]	RO	FLOAT32
40196	195	VRMS HARMONIC 2 [V] LSW			RO	
40197	196	VRMS HARMONIC 2 [V] MSW	L2-N	Measurement of the Phase - Neutral VRMS of the i-th harmonic [V]	RO	FLOAT32
40198	197	VRMS HARMONIC 2 [V] LSW			RO	

ADDRESS (4x)	ADDRESS OFFSET	REGISTER	PHASE	DESCRIPTION	W/R	TYPE
40199	198	VRMS HARMONIC 2 [V] MSW	L3-N	Measurement of the Phase - Neutral VRMS of the i-th harmonic [V]	RO	FLOAT32
40200	199	VRMS HARMONIC 2 [V] LSW			RO	
40201	200	VRMS HARMONIC 3 [V] MSW	L1-N	Measurement of the Phase - Neutral VRMS of the i-th harmonic [V]	RO	FLOAT32
40202	201	VRMS HARMONIC 3 [V] LSW			RO	
40203	202	VRMS HARMONIC 3 [V] MSW	L2-N	Measurement of the Phase - Neutral VRMS of the i-th harmonic [V]	RO	FLOAT32
40204	203	VRMS HARMONIC 3 [V] LSW			RO	
40205	204	VRMS HARMONIC 3 [V] MSW	L3-N	Measurement of the Phase - Neutral VRMS of the i-th harmonic [V]	RO	FLOAT32
40206	205	VRMS HARMONIC 3 [V] LSW			RO	
40207	206	VRMS HARMONIC 4 [V] MSW	L1-N	Measurement of the Phase - Neutral VRMS of the i-th harmonic [V]	RO	FLOAT32
40208	207	VRMS HARMONIC 4 [V] LSW			RO	
40209	208	VRMS HARMONIC 4 [V] MSW	L2-N	Measurement of the Phase - Neutral VRMS of the i-th harmonic [V]	RO	FLOAT32
40210	209	VRMS HARMONIC 4 [V] LSW			RO	
40211	210	VRMS HARMONIC 4 [V] MSW	L3-N	Measurement of the Phase - Neutral VRMS of the i-th harmonic [V]	RO	FLOAT32
40212	211	VRMS HARMONIC 4 [V] LSW			RO	
40213	212	VRMS HARMONIC 5 [V] MSW	L1-N	Measurement of the Phase - Neutral VRMS of the i-th harmonic [V]	RO	FLOAT32
40214	213	VRMS HARMONIC 5 [V] LSW			RO	
40215	214	VRMS HARMONIC 5 [V] MSW	L2-N	Measurement of the Phase - Neutral VRMS of the i-th harmonic [V]	RO	FLOAT32
40216	215	VRMS HARMONIC 5 [V] LSW			RO	
40217	216	VRMS HARMONIC 5 [V] MSW	L3-N	Measurement of the Phase - Neutral VRMS of the i-th harmonic [V]	RO	FLOAT32
40218	217	VRMS HARMONIC 5 [V] LSW			RO	
40219	218	VRMS HARMONIC 6 [V] MSW	L1-N	Measurement of the Phase - Neutral VRMS of the i-th harmonic [V]	RO	FLOAT32
40220	219	VRMS HARMONIC 6 [V] LSW			RO	
40221	220	VRMS HARMONIC 6 [V] MSW	L2-N	Measurement of the Phase - Neutral VRMS of the i-th harmonic [V]	RO	FLOAT32
40222	221	VRMS HARMONIC 6 [V] LSW			RO	
40223	222	VRMS HARMONIC 6 [V] MSW	L3-N	Measurement of the Phase - Neutral VRMS	RO	FLOAT32
40224	223	VRMS HARMONIC 6 [V] LSW			RO	

ADDRESS (4x)	ADDRESS OFFSET	REGISTER	PHASE	DESCRIPTION	W/R	TYPE
				of the i-th harmonic [V]		
40225	224	VRMS HARMONIC 7 [V] MSW	L1-N	Measurement of the Phase - Neutral VRMS of the i-th harmonic [V]	RO	FLOAT32
40226	225	VRMS HARMONIC 7 [V] LSW			RO	
40227	226	VRMS HARMONIC 7 [V] MSW	L2-N	Measurement of the Phase - Neutral VRMS of the i-th harmonic [V]	RO	FLOAT32
40228	227	VRMS HARMONIC 7 [V] LSW			RO	
40229	228	VRMS HARMONIC 7 [V] MSW	L3-N	Measurement of the Phase - Neutral VRMS of the i-th harmonic [V]	RO	FLOAT32
40230	229	VRMS HARMONIC 7 [V] LSW			RO	
40231	230	VRMS HARMONIC 8 [V] MSW	L1-N	Measurement of the Phase - Neutral VRMS of the i-th harmonic [V]	RO	FLOAT32
40232	231	VRMS HARMONIC 8 [V] LSW			RO	
40233	232	VRMS HARMONIC 8 [V] MSW	L2-N	Measurement of the Phase - Neutral VRMS of the i-th harmonic [V]	RO	FLOAT32
40234	233	VRMS HARMONIC 8 [V] LSW			RO	
40235	234	VRMS HARMONIC 8 [V] MSW	L3-N	Measurement of the Phase - Neutral VRMS of the i-th harmonic [V]	RO	FLOAT32
40236	235	VRMS HARMONIC 8 [V] LSW			RO	
40237	236	VRMS HARMONIC 9 [V] MSW	L1-N	Measurement of the Phase - Neutral VRMS of the i-th harmonic [V]	RO	FLOAT32
40238	237	VRMS HARMONIC 9 [V] LSW			RO	
40239	238	VRMS HARMONIC 9 [V] MSW	L2-N	Measurement of the Phase - Neutral VRMS of the i-th harmonic [V]	RO	FLOAT32
40240	239	VRMS HARMONIC 9 [V] LSW			RO	
40241	240	VRMS HARMONIC 9 [V] MSW	L3-N	Measurement of the Phase - Neutral VRMS of the i-th harmonic [V]	RO	FLOAT32
40242	241	VRMS HARMONIC 9 [V] LSW			RO	
40243	242	VRMS HARMONIC 10 [V] MSW	L1-N	Measurement of the Phase - Neutral VRMS of the i-th harmonic [V]	RO	FLOAT32
40244	243	VRMS HARMONIC 10 [V] LSW			RO	
40245	244	VRMS HARMONIC 10 [V] MSW	L2-N	Measurement of the Phase - Neutral VRMS of the i-th harmonic [V]	RO	FLOAT32
40246	245	VRMS HARMONIC 10 [V] LSW			RO	
40247	246	VRMS HARMONIC 10 [V] MSW	L3-N	Measurement of the Phase - Neutral VRMS of the i-th harmonic [V]	RO	FLOAT32
40248	247	VRMS HARMONIC 10 [V] LSW			RO	

ADDRESS (4x)	ADDRESS OFFSET	REGISTER	PHASE	DESCRIPTION	W/R	TYPE
40249	248	VRMS HARMONIC 11 [V] MSW	L1-N	Measurement of the Phase - Neutral VRMS of the i-th harmonic [V]	RO	FLOAT32
40250	249	VRMS HARMONIC 11 [V] LSW			RO	
40251	250	VRMS HARMONIC 11 [V] MSW	L2-N	Measurement of the Phase - Neutral VRMS of the i-th harmonic [V]	RO	FLOAT32
40252	251	VRMS HARMONIC 11 [V] LSW			RO	
40253	252	VRMS HARMONIC 11 [V] MSW	L3-N	Measurement of the Phase - Neutral VRMS of the i-th harmonic [V]	RO	FLOAT32
40254	253	VRMS HARMONIC 11 [V] LSW			RO	
40255	254	VRMS HARMONIC 12 [V] MSW	L1-N	Measurement of the Phase - Neutral VRMS of the i-th harmonic [V]	RO	FLOAT32
40256	255	VRMS HARMONIC 12 [V] LSW			RO	
40257	256	VRMS HARMONIC 12 [V] MSW	L2-N	Measurement of the Phase - Neutral VRMS of the i-th harmonic [V]	RO	FLOAT32
40258	257	VRMS HARMONIC 12 [V] LSW			RO	
40259	258	VRMS HARMONIC 12 [V] MSW	L3-N	Measurement of the Phase - Neutral VRMS of the i-th harmonic [V]	RO	FLOAT32
40260	259	VRMS HARMONIC 12 [V] LSW			RO	
40261	260	VRMS HARMONIC 13 [V] MSW	L1-N	Measurement of the Phase - Neutral VRMS of the i-th harmonic [V]	RO	FLOAT32
40262	261	VRMS HARMONIC 13 [V] LSW			RO	
40263	262	VRMS HARMONIC 13 [V] MSW	L2-N	Measurement of the Phase - Neutral VRMS of the i-th harmonic [V]	RO	FLOAT32
40264	263	VRMS HARMONIC 13 [V] LSW			RO	
40265	264	VRMS HARMONIC 13 [V] MSW	L3-N	Measurement of the Phase - Neutral VRMS of the i-th harmonic [V]	RO	FLOAT32
40266	265	VRMS HARMONIC 13 [V] LSW			RO	
40267	266	VRMS HARMONIC 14 [V] MSW	L1-N	Measurement of the Phase - Neutral VRMS of the i-th harmonic [V]	RO	FLOAT32
40268	267	VRMS HARMONIC 14 [V] LSW			RO	
40269	268	VRMS HARMONIC 14 [V] MSW	L2-N	Measurement of the Phase - Neutral VRMS of the i-th harmonic [V]	RO	FLOAT32
40270	269	VRMS HARMONIC 14 [V] LSW			RO	
40271	270	VRMS HARMONIC 14 [V] MSW	L3-N	Measurement of the Phase - Neutral VRMS of the i-th harmonic [V]	RO	FLOAT32
40272	271	VRMS HARMONIC 14 [V] LSW			RO	
40273	272	VRMS HARMONIC 15 [V] MSW	L1-N	Measurement of the Phase - Neutral VRMS	RO	FLOAT32
40274	273	VRMS HARMONIC 15 [V] LSW			RO	

ADDRESS (4x)	ADDRESS OFFSET	REGISTER	PHASE	DESCRIPTION	W/R	TYPE
				of the i-th harmonic [V]		
40275	274	VRMS HARMONIC 15 [V] MSW	L2-N	Measurement of the Phase - Neutral VRMS of the i-th harmonic [V]	RO	FLOAT32
40276	275	VRMS HARMONIC 15 [V] LSW			RO	
40277	276	VRMS HARMONIC 15 [V] MSW	L3-N	Measurement of the Phase - Neutral VRMS of the i-th harmonic [V]	RO	FLOAT32
40278	277	VRMS HARMONIC 15 [V] LSW			RO	
40279	278	VRMS HARMONIC 16 [V] MSW	L1-N	Measurement of the Phase - Neutral VRMS of the i-th harmonic [V]	RO	FLOAT32
40280	279	VRMS HARMONIC 16 [V] LSW			RO	
40281	280	VRMS HARMONIC 16 [V] MSW	L2-N	Measurement of the Phase - Neutral VRMS of the i-th harmonic [V]	RO	FLOAT32
40282	281	VRMS HARMONIC 16 [V] LSW			RO	
40283	282	VRMS HARMONIC 16 [V] MSW	L3-N	Measurement of the Phase - Neutral VRMS of the i-th harmonic [V]	RO	FLOAT32
40284	283	VRMS HARMONIC 16 [V] LSW			RO	
40285	284	VRMS HARMONIC 17 [V] MSW	L1-N	Measurement of the Phase - Neutral VRMS of the i-th harmonic [V]	RO	FLOAT32
40286	285	VRMS HARMONIC 17 [V] LSW			RO	
40287	286	VRMS HARMONIC 17 [V] MSW	L2-N	Measurement of the Phase - Neutral VRMS of the i-th harmonic [V]	RO	FLOAT32
40288	287	VRMS HARMONIC 17 [V] LSW			RO	
40289	288	VRMS HARMONIC 17 [V] MSW	L3-N	Measurement of the Phase - Neutral VRMS of the i-th harmonic [V]	RO	FLOAT32
40290	289	VRMS HARMONIC 17 [V] LSW			RO	
40291	290	VRMS HARMONIC 18 [V] MSW	L1-N	Measurement of the Phase - Neutral VRMS of the i-th harmonic [V]	RO	FLOAT32
40292	291	VRMS HARMONIC 18 [V] LSW			RO	
40293	292	VRMS HARMONIC 18 [V] MSW	L2-N	Measurement of the Phase - Neutral VRMS of the i-th harmonic [V]	RO	FLOAT32
40294	293	VRMS HARMONIC 18 [V] LSW			RO	
40295	294	VRMS HARMONIC 18 [V] MSW	L3-N	Measurement of the Phase - Neutral VRMS of the i-th harmonic [V]	RO	FLOAT32
40296	295	VRMS HARMONIC 18 [V] LSW			RO	
40297	296	VRMS HARMONIC 19 [V] MSW	L1-N	Measurement of the Phase - Neutral VRMS of the i-th harmonic [V]	RO	FLOAT32
40298	297	VRMS HARMONIC 19 [V] LSW			RO	

ADDRESS (4x)	ADDRESS OFFSET	REGISTER	PHASE	DESCRIPTION	W/R	TYPE
40299	298	VRMS HARMONIC 19 [V] MSW	L2-N	Measurement of the Phase - Neutral VRMS of the i-th harmonic [V]	RO	FLOAT32
40300	299	VRMS HARMONIC 19 [V] LSW			RO	
40301	300	VRMS HARMONIC 19 [V] MSW	L3-N	Measurement of the Phase - Neutral VRMS of the i-th harmonic [V]	RO	FLOAT32
40302	301	VRMS HARMONIC 19 [V] LSW			RO	
40303	302	VRMS HARMONIC 20 [V] MSW	L1-N	Measurement of the Phase - Neutral VRMS of the i-th harmonic [V]	RO	FLOAT32
40304	303	VRMS HARMONIC 20 [V] LSW			RO	
40305	304	VRMS HARMONIC 20 [V] MSW	L2-N	Measurement of the Phase - Neutral VRMS of the i-th harmonic [V]	RO	FLOAT32
40306	305	VRMS HARMONIC 20 [V] LSW			RO	
40307	306	VRMS HARMONIC 20 [V] MSW	L3-N	Measurement of the Phase - Neutral VRMS of the i-th harmonic [V]	RO	FLOAT32
40308	307	VRMS HARMONIC 20 [V] LSW			RO	
40309	308	VRMS HARMONIC 21 [V] MSW	L1-N	Measurement of the Phase - Neutral VRMS of the i-th harmonic [V]	RO	FLOAT32
40310	309	VRMS HARMONIC 21 [V] LSW			RO	
40311	310	VRMS HARMONIC 21 [V] MSW	L2-N	Measurement of the Phase - Neutral VRMS of the i-th harmonic [V]	RO	FLOAT32
40312	311	VRMS HARMONIC 21 [V] LSW			RO	
40313	312	VRMS HARMONIC 21 [V] MSW	L3-N	Measurement of the Phase - Neutral VRMS of the i-th harmonic [V]	RO	FLOAT32
40314	313	VRMS HARMONIC 21 [V] LSW			RO	
40315	314	VRMS HARMONIC 22 [V] MSW	L1-N	Measurement of the Phase - Neutral VRMS of the i-th harmonic [V]	RO	FLOAT32
40316	315	VRMS HARMONIC 22 [V] LSW			RO	
40317	316	VRMS HARMONIC 22 [V] MSW	L2-N	Measurement of the Phase - Neutral VRMS of the i-th harmonic [V]	RO	FLOAT32
40318	317	VRMS HARMONIC 22 [V] LSW			RO	
40319	318	VRMS HARMONIC 22 [V] MSW	L3-N	Measurement of the Phase - Neutral VRMS of the i-th harmonic [V]	RO	FLOAT32
40320	319	VRMS HARMONIC 22 [V] LSW			RO	
40321	320	VRMS HARMONIC 23 [V] MSW	L1-N	Measurement of the Phase - Neutral VRMS of the i-th harmonic [V]	RO	FLOAT32
40322	321	VRMS HARMONIC 23 [V] LSW			RO	
40323	322	VRMS HARMONIC 23 [V] MSW	L2-N	Measurement of the Phase - Neutral VRMS	RO	FLOAT32
40324	323	VRMS HARMONIC 23 [V] LSW			RO	

ADDRESS (4x)	ADDRESS OFFSET	REGISTER	PHASE	DESCRIPTION	W/R	TYPE
				of the i-th harmonic [V]		
40325	324	VRMS HARMONIC 23 [V] MSW	L3-N	Measurement of the Phase - Neutral VRMS of the i-th harmonic [V]	RO	FLOAT32
40326	325	VRMS HARMONIC 23 [V] LSW			RO	
40327	326	VRMS HARMONIC 24 [V] MSW	L1-N	Measurement of the Phase - Neutral VRMS of the i-th harmonic [V]	RO	FLOAT32
40328	327	VRMS HARMONIC 24 [V] LSW			RO	
40329	328	VRMS HARMONIC 24 [V] MSW	L2-N	Measurement of the Phase - Neutral VRMS of the i-th harmonic [V]	RO	FLOAT32
40330	329	VRMS HARMONIC 24 [V] LSW			RO	
40331	330	VRMS HARMONIC 24 [V] MSW	L3-N	Measurement of the Phase - Neutral VRMS of the i-th harmonic [V]	RO	FLOAT32
40332	331	VRMS HARMONIC 24 [V] LSW			RO	
40333	332	VRMS HARMONIC 25 [V] MSW	L1-N	Measurement of the Phase - Neutral VRMS of the i-th harmonic [V]	RO	FLOAT32
40334	333	VRMS HARMONIC 25 [V] LSW			RO	
40335	334	VRMS HARMONIC 25 [V] MSW	L2-N	Measurement of the Phase - Neutral VRMS of the i-th harmonic [V]	RO	FLOAT32
40336	335	VRMS HARMONIC 25 [V] LSW			RO	
40337	336	VRMS HARMONIC 25 [V] MSW	L3-N	Measurement of the Phase - Neutral VRMS of the i-th harmonic [V]	RO	FLOAT32
40338	337	VRMS HARMONIC 25 [V] LSW			RO	
40339	338	VRMS HARMONIC 26 [V] MSW	L1-N	Measurement of the Phase - Neutral VRMS of the i-th harmonic [V]	RO	FLOAT32
40340	339	VRMS HARMONIC 26 [V] LSW			RO	
40341	340	VRMS HARMONIC 26 [V] MSW	L2-N	Measurement of the Phase - Neutral VRMS of the i-th harmonic [V]	RO	FLOAT32
40342	341	VRMS HARMONIC 26 [V] LSW			RO	
40343	342	VRMS HARMONIC 26 [V] MSW	L3-N	Measurement of the Phase - Neutral VRMS of the i-th harmonic [V]	RO	FLOAT32
40344	343	VRMS HARMONIC 26 [V] LSW			RO	
40345	344	VRMS HARMONIC 27 [V] MSW	L1-N	Measurement of the Phase - Neutral VRMS of the i-th harmonic [V]	RO	FLOAT32
40346	345	VRMS HARMONIC 27 [V] LSW			RO	
40347	346	VRMS HARMONIC 27 [V] MSW	L2-N	Measurement of the Phase - Neutral VRMS of the i-th harmonic [V]	RO	FLOAT32
40348	347	VRMS HARMONIC 27 [V] LSW			RO	

ADDRESS (4x)	ADDRESS OFFSET	REGISTER	PHASE	DESCRIPTION	W/R	TYPE
40349	348	VRMS HARMONIC 27 [V] MSW	L3-N	Measurement of the Phase - Neutral VRMS of the i-th harmonic [V]	RO	FLOAT32
40350	349	VRMS HARMONIC 27 [V] LSW			RO	
40351	350	VRMS HARMONIC 28 [V] MSW	L1-N	Measurement of the Phase - Neutral VRMS of the i-th harmonic [V]	RO	FLOAT32
40352	351	VRMS HARMONIC 28 [V] LSW			RO	
40353	352	VRMS HARMONIC 28 [V] MSW	L2-N	Measurement of the Phase - Neutral VRMS of the i-th harmonic [V]	RO	FLOAT32
40354	353	VRMS HARMONIC 28 [V] LSW			RO	
40355	354	VRMS HARMONIC 28 [V] MSW	L3-N	Measurement of the Phase - Neutral VRMS of the i-th harmonic [V]	RO	FLOAT32
40356	355	VRMS HARMONIC 28 [V] LSW			RO	
40357	356	VRMS HARMONIC 29 [V] MSW	L1-N	Measurement of the Phase - Neutral VRMS of the i-th harmonic [V]	RO	FLOAT32
40358	357	VRMS HARMONIC 29 [V] LSW			RO	
40359	358	VRMS HARMONIC 29 [V] MSW	L2-N	Measurement of the Phase - Neutral VRMS of the i-th harmonic [V]	RO	FLOAT32
40360	359	VRMS HARMONIC 29 [V] LSW			RO	
40361	360	VRMS HARMONIC 29 [V] MSW	L3-N	Measurement of the Phase - Neutral VRMS of the i-th harmonic [V]	RO	FLOAT32
40362	361	VRMS HARMONIC 29 [V] LSW			RO	
40363	362	VRMS HARMONIC 30 [V] MSW	L1-N	Measurement of the Phase - Neutral VRMS of the i-th harmonic [V]	RO	FLOAT32
40364	363	VRMS HARMONIC 30 [V] LSW			RO	
40365	364	VRMS HARMONIC 30 [V] MSW	L2-N	Measurement of the Phase - Neutral VRMS of the i-th harmonic [V]	RO	FLOAT32
40366	365	VRMS HARMONIC 30 [V] LSW			RO	
40367	366	VRMS HARMONIC 30 [V] MSW	L3-N	Measurement of the Phase - Neutral VRMS of the i-th harmonic [V]	RO	FLOAT32
40368	367	VRMS HARMONIC 30 [V] LSW			RO	
40369	368	VRMS HARMONIC 31 [V] MSW	L1-N	Measurement of the Phase - Neutral VRMS of the i-th harmonic [V]	RO	FLOAT32
40370	369	VRMS HARMONIC 31 [V] LSW			RO	
40371	370	VRMS HARMONIC 31 [V] MSW	L2-N	Measurement of the Phase - Neutral VRMS of the i-th harmonic [V]	RO	FLOAT32
40372	371	VRMS HARMONIC 31 [V] LSW			RO	
40373	372	VRMS HARMONIC 31 [V] MSW	L3-N	Measurement of the Phase - Neutral VRMS	RO	FLOAT32
40374	373	VRMS HARMONIC 31 [V] LSW			RO	

ADDRESS (4x)	ADDRESS OFFSET	REGISTER	PHASE	DESCRIPTION	W/R	TYPE
				of the i-th harmonic [V]		
40375	374	VRMS HARMONIC 32 [V] MSW	L1-N	Measurement of the Phase - Neutral VRMS of the i-th harmonic [V]	RO	FLOAT32
40376	375	VRMS HARMONIC 32 [V] LSW			RO	
40377	376	VRMS HARMONIC 32 [V] MSW	L2-N	Measurement of the Phase - Neutral VRMS of the i-th harmonic [V]	RO	FLOAT32
40378	377	VRMS HARMONIC 32 [V] LSW			RO	
40379	378	VRMS HARMONIC 32 [V] MSW	L3-N	Measurement of the Phase - Neutral VRMS of the i-th harmonic [V]	RO	FLOAT32
40380	379	VRMS HARMONIC 32 [V] LSW			RO	
40381	380	VRMS HARMONIC 33 [V] MSW	L1-N	Measurement of the Phase - Neutral VRMS of the i-th harmonic [V]	RO	FLOAT32
40382	381	VRMS HARMONIC 33 [V] LSW			RO	
40383	382	VRMS HARMONIC 33 [V] MSW	L2-N	Measurement of the Phase - Neutral VRMS of the i-th harmonic [V]	RO	FLOAT32
40384	383	VRMS HARMONIC 33 [V] LSW			RO	
40385	384	VRMS HARMONIC 33 [V] MSW	L3-N	Measurement of the Phase - Neutral VRMS of the i-th harmonic [V]	RO	FLOAT32
40386	385	VRMS HARMONIC 33 [V] LSW			RO	
40387	386	VRMS HARMONIC 34 [V] MSW	L1-N	Measurement of the Phase - Neutral VRMS of the i-th harmonic [V]	RO	FLOAT32
40388	387	VRMS HARMONIC 34 [V] LSW			RO	
40389	388	VRMS HARMONIC 34 [V] MSW	L2-N	Measurement of the Phase - Neutral VRMS of the i-th harmonic [V]	RO	FLOAT32
40390	389	VRMS HARMONIC 34 [V] LSW			RO	
40391	390	VRMS HARMONIC 34 [V] MSW	L3-N	Measurement of the Phase - Neutral VRMS of the i-th harmonic [V]	RO	FLOAT32
40392	391	VRMS HARMONIC 34 [V] LSW			RO	
40393	392	VRMS HARMONIC 35 [V] MSW	L1-N	Measurement of the Phase - Neutral VRMS of the i-th harmonic [V]	RO	FLOAT32
40394	393	VRMS HARMONIC 35 [V] LSW			RO	
40395	394	VRMS HARMONIC 35 [V] MSW	L2-N	Measurement of the Phase - Neutral VRMS of the i-th harmonic [V]	RO	FLOAT32
40396	395	VRMS HARMONIC 35 [V] LSW			RO	
40397	396	VRMS HARMONIC 35 [V] MSW	L3-N	Measurement of the Phase - Neutral VRMS of the i-th harmonic [V]	RO	FLOAT32
40398	397	VRMS HARMONIC 35 [V] LSW			RO	

ADDRESS (4x)	ADDRESS OFFSET	REGISTER	PHASE	DESCRIPTION	W/R	TYPE
40399	398	VRMS HARMONIC 36 [V] MSW	L1-N	Measurement of the Phase - Neutral VRMS of the i-th harmonic [V]	RO	FLOAT32
40400	399	VRMS HARMONIC 36 [V] LSW			RO	
40401	400	VRMS HARMONIC 36 [V] MSW	L2-N	Measurement of the Phase - Neutral VRMS of the i-th harmonic [V]	RO	FLOAT32
40402	401	VRMS HARMONIC 36 [V] LSW			RO	
40403	402	VRMS HARMONIC 36 [V] MSW	L3-N	Measurement of the Phase - Neutral VRMS of the i-th harmonic [V]	RO	FLOAT32
40404	403	VRMS HARMONIC 36 [V] LSW			RO	
40405	404	VRMS HARMONIC 37 [V] MSW	L1-N	Measurement of the Phase - Neutral VRMS of the i-th harmonic [V]	RO	FLOAT32
40406	405	VRMS HARMONIC 37 [V] LSW			RO	
40407	406	VRMS HARMONIC 37 [V] MSW	L2-N	Measurement of the Phase - Neutral VRMS of the i-th harmonic [V]	RO	FLOAT32
40408	407	VRMS HARMONIC 37 [V] LSW			RO	
40409	408	VRMS HARMONIC 37 [V] MSW	L3-N	Measurement of the Phase - Neutral VRMS of the i-th harmonic [V]	RO	FLOAT32
40410	409	VRMS HARMONIC 37 [V] LSW			RO	
40411	410	VRMS HARMONIC 38 [V] MSW	L1-N	Measurement of the Phase - Neutral VRMS of the i-th harmonic [V]	RO	FLOAT32
40412	411	VRMS HARMONIC 38 [V] LSW			RO	
40413	412	VRMS HARMONIC 38 [V] MSW	L2-N	Measurement of the Phase - Neutral VRMS of the i-th harmonic [V]	RO	FLOAT32
40414	413	VRMS HARMONIC 38 [V] LSW			RO	
40415	414	VRMS HARMONIC 38 [V] MSW	L3-N	Measurement of the Phase - Neutral VRMS of the i-th harmonic [V]	RO	FLOAT32
40416	415	VRMS HARMONIC 38 [V] LSW			RO	
40417	416	VRMS HARMONIC 39 [V] MSW	L1-N	Measurement of the Phase - Neutral VRMS of the i-th harmonic [V]	RO	FLOAT32
40418	417	VRMS HARMONIC 39 [V] LSW			RO	
40419	418	VRMS HARMONIC 39 [V] MSW	L2-N	Measurement of the Phase - Neutral VRMS of the i-th harmonic [V]	RO	FLOAT32
40420	419	VRMS HARMONIC 39 [V] LSW			RO	
40421	420	VRMS HARMONIC 39 [V] MSW	L3-N	Measurement of the Phase - Neutral VRMS of the i-th harmonic [V]	RO	FLOAT32
40422	421	VRMS HARMONIC 39 [V] LSW			RO	
40423	422	VRMS HARMONIC 40 [V] MSW	L1-N	Measurement of the Phase - Neutral VRMS	RO	FLOAT32
40424	423	VRMS HARMONIC 40 [V] LSW			RO	

ADDRESS (4x)	ADDRESS OFFSET	REGISTER	PHASE	DESCRIPTION	W/R	TYPE
				of the i-th harmonic [V]		
40425	424	VRMS HARMONIC 40 [V] MSW	L2-N	Measurement of the Phase - Neutral VRMS of the i-th harmonic [V]	RO	FLOAT32
40426	425	VRMS HARMONIC 40 [V] LSW			RO	
40427	426	VRMS HARMONIC 40 [V] MSW	L3-N	Measurement of the Phase - Neutral VRMS of the i-th harmonic [V]	RO	FLOAT32
40428	427	VRMS HARMONIC 40 [V] LSW			RO	
40429	428	VRMS HARMONIC 41 [V] MSW	L1-N	Measurement of the Phase - Neutral VRMS of the i-th harmonic [V]	RO	FLOAT32
40430	429	VRMS HARMONIC 41 [V] LSW			RO	
40431	430	VRMS HARMONIC 41 [V] MSW	L2-N	Measurement of the Phase - Neutral VRMS of the i-th harmonic [V]	RO	FLOAT32
40432	431	VRMS HARMONIC 41 [V] LSW			RO	
40433	432	VRMS HARMONIC 41 [V] MSW	L3-N	Measurement of the Phase - Neutral VRMS of the i-th harmonic [V]	RO	FLOAT32
40434	433	VRMS HARMONIC 41 [V] LSW			RO	
40435	434	VRMS HARMONIC 42 [V] MSW	L1-N	Measurement of the Phase - Neutral VRMS of the i-th harmonic [V]	RO	FLOAT32
40436	435	VRMS HARMONIC 42 [V] LSW			RO	
40437	436	VRMS HARMONIC 42 [V] MSW	L2-N	Measurement of the Phase - Neutral VRMS of the i-th harmonic [V]	RO	FLOAT32
40438	437	VRMS HARMONIC 42 [V] LSW			RO	
40439	438	VRMS HARMONIC 42 [V] MSW	L3-N	Measurement of the Phase - Neutral VRMS of the i-th harmonic [V]	RO	FLOAT32
40440	439	VRMS HARMONIC 42 [V] LSW			RO	
40441	440	VRMS HARMONIC 43 [V] MSW	L1-N	Measurement of the Phase - Neutral VRMS of the i-th harmonic [V]	RO	FLOAT32
40442	441	VRMS HARMONIC 43 [V] LSW			RO	
40443	442	VRMS HARMONIC 43 [V] MSW	L2-N	Measurement of the Phase - Neutral VRMS of the i-th harmonic [V]	RO	FLOAT32
40444	443	VRMS HARMONIC 43 [V] LSW			RO	
40445	444	VRMS HARMONIC 43 [V] MSW	L3-N	Measurement of the Phase - Neutral VRMS of the i-th harmonic [V]	RO	FLOAT32
40446	445	VRMS HARMONIC 43 [V] LSW			RO	
40447	446	VRMS HARMONIC 44 [V] MSW	L1-N	Measurement of the Phase - Neutral VRMS of the i-th harmonic [V]	RO	FLOAT32
40448	447	VRMS HARMONIC 44 [V] LSW			RO	

ADDRESS (4x)	ADDRESS OFFSET	REGISTER	PHASE	DESCRIPTION	W/R	TYPE
40449	448	VRMS HARMONIC 44 [V] MSW	L2-N	Measurement of the Phase - Neutral VRMS of the i-th harmonic [V]	RO	FLOAT32
40450	449	VRMS HARMONIC 44 [V] LSW			RO	
40451	450	VRMS HARMONIC 44 [V] MSW	L3-N	Measurement of the Phase - Neutral VRMS of the i-th harmonic [V]	RO	FLOAT32
40452	451	VRMS HARMONIC 44 [V] LSW			RO	
40453	452	VRMS HARMONIC 45 [V] MSW	L1-N	Measurement of the Phase - Neutral VRMS of the i-th harmonic [V]	RO	FLOAT32
40454	453	VRMS HARMONIC 45 [V] LSW			RO	
40455	454	VRMS HARMONIC 45 [V] MSW	L2-N	Measurement of the Phase - Neutral VRMS of the i-th harmonic [V]	RO	FLOAT32
40456	455	VRMS HARMONIC 45 [V] LSW			RO	
40457	456	VRMS HARMONIC 45 [V] MSW	L3-N	Measurement of the Phase - Neutral VRMS of the i-th harmonic [V]	RO	FLOAT32
40458	457	VRMS HARMONIC 45 [V] LSW			RO	
40459	458	VRMS HARMONIC 46 [V] MSW	L1-N	Measurement of the Phase - Neutral VRMS of the i-th harmonic [V]	RO	FLOAT32
40460	459	VRMS HARMONIC 46 [V] LSW			RO	
40461	460	VRMS HARMONIC 46 [V] MSW	L2-N	Measurement of the Phase - Neutral VRMS of the i-th harmonic [V]	RO	FLOAT32
40462	461	VRMS HARMONIC 46 [V] LSW			RO	
40463	462	VRMS HARMONIC 46 [V] MSW	L3-N	Measurement of the Phase - Neutral VRMS of the i-th harmonic [V]	RO	FLOAT32
40464	463	VRMS HARMONIC 46 [V] LSW			RO	
40465	464	VRMS HARMONIC 47 [V] MSW	L1-N	Measurement of the Phase - Neutral VRMS of the i-th harmonic [V]	RO	FLOAT32
40466	465	VRMS HARMONIC 47 [V] LSW			RO	
40467	466	VRMS HARMONIC 47 [V] MSW	L2-N	Measurement of the Phase - Neutral VRMS of the i-th harmonic [V]	RO	FLOAT32
40468	467	VRMS HARMONIC 47 [V] LSW			RO	
40469	468	VRMS HARMONIC 47 [V] MSW	L3-N	Measurement of the Phase - Neutral VRMS of the i-th harmonic [V]	RO	FLOAT32
40470	469	VRMS HARMONIC 47 [V] LSW			RO	
40471	470	VRMS HARMONIC 48 [V] MSW	L1-N	Measurement of the Phase - Neutral VRMS of the i-th harmonic [V]	RO	FLOAT32
40472	471	VRMS HARMONIC 48 [V] LSW			RO	
40473	472	VRMS HARMONIC 48 [V] MSW	L2-N	Measurement of the Phase - Neutral VRMS	RO	FLOAT32
40474	473	VRMS HARMONIC 48 [V] LSW			RO	

ADDRESS (4x)	ADDRESS OFFSET	REGISTER	PHASE	DESCRIPTION	W/R	TYPE
				of the i-th harmonic [V]		
40475	474	VRMS HARMONIC 48 [V] MSW	L3-N	Measurement of the Phase - Neutral VRMS of the i-th harmonic [V]	RO	FLOAT32
40476	475	VRMS HARMONIC 48 [V] LSW			RO	
40477	476	VRMS HARMONIC 49 [V] MSW	L1-N	Measurement of the Phase - Neutral VRMS of the i-th harmonic [V]	RO	FLOAT32
40478	477	VRMS HARMONIC 49 [V] LSW			RO	
40479	478	VRMS HARMONIC 49 [V] MSW	L2-N	Measurement of the Phase - Neutral VRMS of the i-th harmonic [V]	RO	FLOAT32
40480	479	VRMS HARMONIC 49 [V] LSW			RO	
40481	480	VRMS HARMONIC 49 [V] MSW	L3-N	Measurement of the Phase - Neutral VRMS of the i-th harmonic [V]	RO	FLOAT32
40482	481	VRMS HARMONIC 49 [V] LSW			RO	
40483	482	VRMS HARMONIC 50 [V] MSW	L1-N	Measurement of the Phase - Neutral VRMS of the i-th harmonic [V]	RO	FLOAT32
40484	483	VRMS HARMONIC 50 [V] LSW			RO	
40485	484	VRMS HARMONIC 50 [V] MSW	L2-N	Measurement of the Phase - Neutral VRMS of the i-th harmonic [V]	RO	FLOAT32
40486	485	VRMS HARMONIC 50 [V] LSW			RO	
40487	486	VRMS HARMONIC 50 [V] MSW	L3-N	Measurement of the Phase - Neutral VRMS of the i-th harmonic [V]	RO	FLOAT32
40488	487	VRMS HARMONIC 50 [V] LSW			RO	
40489	488	VRMS HARMONIC 51 [V] MSW	L1-N	Measurement of the Phase - Neutral VRMS of the i-th harmonic [V]	RO	FLOAT32
40490	489	VRMS HARMONIC 51 [V] LSW			RO	
40491	490	VRMS HARMONIC 51 [V] MSW	L2-N	Measurement of the Phase - Neutral VRMS of the i-th harmonic [V]	RO	FLOAT32
40492	491	VRMS HARMONIC 51 [V] LSW			RO	
40493	492	VRMS HARMONIC 51 [V] MSW	L3-N	Measurement of the Phase - Neutral VRMS of the i-th harmonic [V]	RO	FLOAT32
40494	493	VRMS HARMONIC 51 [V] LSW			RO	
40495	494	VRMS HARMONIC 52 [V] MSW	L1-N	Measurement of the Phase - Neutral VRMS of the i-th harmonic [V]	RO	FLOAT32
40496	495	VRMS HARMONIC 52 [V] LSW			RO	
40497	496	VRMS HARMONIC 52 [V] MSW	L2-N	Measurement of the Phase - Neutral VRMS of the i-th harmonic [V]	RO	FLOAT32
40498	497	VRMS HARMONIC 52 [V] LSW			RO	

ADDRESS (4x)	ADDRESS OFFSET	REGISTER	PHASE	DESCRIPTION	W/R	TYPE
40499	498	VRMS HARMONIC 52 [V] MSW	L3-N	Measurement of the Phase - Neutral VRMS of the i-th harmonic [V]	RO	FLOAT32
40500	499	VRMS HARMONIC 52 [V] LSW			RO	
40501	500	VRMS HARMONIC 53 [V] MSW	L1-N	Measurement of the Phase - Neutral VRMS of the i-th harmonic [V]	RO	FLOAT32
40502	501	VRMS HARMONIC 53 [V] LSW			RO	
40503	502	VRMS HARMONIC 53 [V] MSW	L2-N	Measurement of the Phase - Neutral VRMS of the i-th harmonic [V]	RO	FLOAT32
40504	503	VRMS HARMONIC 53 [V] LSW			RO	
40505	504	VRMS HARMONIC 53 [V] MSW	L3-N	Measurement of the Phase - Neutral VRMS of the i-th harmonic [V]	RO	FLOAT32
40506	505	VRMS HARMONIC 53 [V] LSW			RO	
40507	506	VRMS HARMONIC 54 [V] MSW	L1-N	Measurement of the Phase - Neutral VRMS of the i-th harmonic [V]	RO	FLOAT32
40508	507	VRMS HARMONIC 54 [V] LSW			RO	
40509	508	VRMS HARMONIC 54 [V] MSW	L2-N	Measurement of the Phase - Neutral VRMS of the i-th harmonic [V]	RO	FLOAT32
40510	509	VRMS HARMONIC 54 [V] LSW			RO	
40511	510	VRMS HARMONIC 54 [V] MSW	L3-N	Measurement of the Phase - Neutral VRMS of the i-th harmonic [V]	RO	FLOAT32
40512	511	VRMS HARMONIC 54 [V] LSW			RO	
40513	512	VRMS HARMONIC 55 [V] MSW	L1-N	Measurement of the Phase - Neutral VRMS of the i-th harmonic [V]	RO	FLOAT32
40514	513	VRMS HARMONIC 55 [V] LSW			RO	
40515	514	VRMS HARMONIC 55 [V] MSW	L2-N	Measurement of the Phase - Neutral VRMS of the i-th harmonic [V]	RO	FLOAT32
40516	515	VRMS HARMONIC 55 [V] LSW			RO	
40517	516	VRMS HARMONIC 55 [V] MSW	L3-N	Measurement of the Phase - Neutral VRMS of the i-th harmonic [V]	RO	FLOAT32
40518	517	VRMS HARMONIC 55 [V] LSW			RO	
40519	518	IRMS FUNDAMENTAL [A] MSW	L1	Measurement of the phase IRMS fundamental alone [A]	RO	FLOAT32
40520	519	IRMS FUNDAMENTAL [A] LSW			RO	
40521	520	IRMS FUNDAMENTAL [A] MSW	L2	Measurement of the phase IRMS fundamental alone [A]	RO	FLOAT32
40522	521	IRMS FUNDAMENTAL [A] LSW			RO	
40523	522	IRMS FUNDAMENTAL [A] MSW	L3	Measurement of the phase IRMS fundamental alone [A]	RO	FLOAT32
40524	523	IRMS FUNDAMENTAL [A] LSW			RO	
40525	524	IRMS HARMONIC 2 [A] MSW	L1		RO	FLOAT32

ADDRESS (4x)	ADDRESS OFFSET	REGISTER	PHASE	DESCRIPTION	W/R	TYPE
40526	525	IRMS HARMONIC 2 [A] LSW		Measurement of the phase IRMS of the i-th harmonic[A]	RO	
40527	526	IRMS HARMONIC 2 [A] MSW	L2	Measurement of the phase IRMS of the i-th harmonic[A]	RO	FLOAT32
40528	527	IRMS HARMONIC 2 [A] LSW			RO	
40529	528	IRMS HARMONIC 2 [A] MSW	L3	Measurement of the phase IRMS of the i-th harmonic[A]	RO	FLOAT32
40530	529	IRMS HARMONIC 2 [A] LSW			RO	
40531	530	IRMS HARMONIC 3 [A] MSW	L1	Measurement of the phase IRMS of the i-th harmonic[A]	RO	FLOAT32
40532	531	IRMS HARMONIC 3 [A] LSW			RO	
40533	532	IRMS HARMONIC 3 [A] MSW	L2	Measurement of the phase IRMS of the i-th harmonic[A]	RO	FLOAT32
40534	533	IRMS HARMONIC 3 [A] LSW			RO	
40535	534	IRMS HARMONIC 3 [A] MSW	L3	Measurement of the phase IRMS of the i-th harmonic[A]	RO	FLOAT32
40536	535	IRMS HARMONIC 3 [A] LSW			RO	
40537	536	IRMS HARMONIC 4 [A] MSW	L1	Measurement of the phase IRMS of the i-th harmonic[A]	RO	FLOAT32
40538	537	IRMS HARMONIC 4 [A] LSW			RO	
40539	538	IRMS HARMONIC 4 [A] MSW	L2	Measurement of the phase IRMS of the i-th harmonic[A]	RO	FLOAT32
40540	539	IRMS HARMONIC 4 [A] LSW			RO	
40541	540	IRMS HARMONIC 4 [A] MSW	L3	Measurement of the phase IRMS of the i-th harmonic[A]	RO	FLOAT32
40542	541	IRMS HARMONIC 4 [A] LSW			RO	
40543	542	IRMS HARMONIC 5 [A] MSW	L1	Measurement of the phase IRMS of the i-th harmonic[A]	RO	FLOAT32
40544	543	IRMS HARMONIC 5 [A] LSW			RO	
40545	544	IRMS HARMONIC 5 [A] MSW	L2	Measurement of the phase IRMS of the i-th harmonic[A]	RO	FLOAT32
40546	545	IRMS HARMONIC 5 [A] LSW			RO	
40547	546	IRMS HARMONIC 5 [A] MSW	L3	Measurement of the phase IRMS of the i-th harmonic[A]	RO	FLOAT32
40548	547	IRMS HARMONIC 5 [A] LSW			RO	
40549	548	IRMS HARMONIC 6 [A] MSW	L1	Measurement of the phase IRMS of the i-th harmonic[A]	RO	FLOAT32
40550	549	IRMS HARMONIC 6 [A] LSW			RO	
40551	550	IRMS HARMONIC 6 [A] MSW	L2	Measurement of the phase IRMS of the i-th harmonic[A]	RO	FLOAT32
40552	551	IRMS HARMONIC 6 [A] LSW			RO	
40553	552	IRMS HARMONIC 6 [A] MSW	L3	Measurement of the phase IRMS of the i-th harmonic[A]	RO	FLOAT32
40554	553	IRMS HARMONIC 6 [A] LSW			RO	
40555	554	IRMS HARMONIC 7 [A] MSW	L1	Measurement of the phase IRMS of the i-th harmonic[A]	RO	FLOAT32
40556	555	IRMS HARMONIC 7 [A] LSW			RO	
40557	556	IRMS HARMONIC 7 [A] MSW	L2		RO	FLOAT32

ADDRESS (4x)	ADDRESS OFFSET	REGISTER	PHASE	DESCRIPTION	W/R	TYPE
40558	557	IRMS HARMONIC 7 [A] LSW		Measurement of the phase IRMS of the i-th harmonic[A]	RO	
40559	558	IRMS HARMONIC 7 [A] MSW	L3	Measurement of the phase IRMS of the i-th harmonic[A]	RO	FLOAT32
40560	559	IRMS HARMONIC 7 [A] LSW			RO	
40561	560	IRMS HARMONIC 8 [A] MSW	L1	Measurement of the phase IRMS of the i-th harmonic[A]	RO	FLOAT32
40562	561	IRMS HARMONIC 8 [A] LSW			RO	
40563	562	IRMS HARMONIC 8 [A] MSW	L2	Measurement of the phase IRMS of the i-th harmonic[A]	RO	FLOAT32
40564	563	IRMS HARMONIC 8 [A] LSW			RO	
40565	564	IRMS HARMONIC 8 [A] MSW	L3	Measurement of the phase IRMS of the i-th harmonic[A]	RO	FLOAT32
40566	565	IRMS HARMONIC 8 [A] LSW			RO	
40567	566	IRMS HARMONIC 9 [A] MSW	L1	Measurement of the phase IRMS of the i-th harmonic[A]	RO	FLOAT32
40568	567	IRMS HARMONIC 9 [A] LSW			RO	
40569	568	IRMS HARMONIC 9 [A] MSW	L2	Measurement of the phase IRMS of the i-th harmonic[A]	RO	FLOAT32
40570	569	IRMS HARMONIC 9 [A] LSW			RO	
40571	570	IRMS HARMONIC 9 [A] MSW	L3	Measurement of the phase IRMS of the i-th harmonic[A]	RO	FLOAT32
40572	571	IRMS HARMONIC 9 [A] LSW			RO	
40573	572	IRMS HARMONIC 10 [A] MSW	L1	Measurement of the phase IRMS of the i-th harmonic[A]	RO	FLOAT32
40574	573	IRMS HARMONIC 10 [A] LSW			RO	
40575	574	IRMS HARMONIC 10 [A] MSW	L2	Measurement of the phase IRMS of the i-th harmonic[A]	RO	FLOAT32
40576	575	IRMS HARMONIC 10 [A] LSW			RO	
40577	576	IRMS HARMONIC 10 [A] MSW	L3	Measurement of the phase IRMS of the i-th harmonic[A]	RO	FLOAT32
40578	577	IRMS HARMONIC 10 [A] LSW			RO	
40579	578	IRMS HARMONIC 11 [A] MSW	L1	Measurement of the phase IRMS of the i-th harmonic[A]	RO	FLOAT32
40580	579	IRMS HARMONIC 11 [A] LSW			RO	
40581	580	IRMS HARMONIC 11 [A] MSW	L2	Measurement of the phase IRMS of the i-th harmonic[A]	RO	FLOAT32
40582	581	IRMS HARMONIC 11 [A] LSW			RO	
40583	582	IRMS HARMONIC 11 [A] MSW	L3	Measurement of the phase IRMS of the i-th harmonic[A]	RO	FLOAT32
40584	583	IRMS HARMONIC 11 [A] LSW			RO	
40585	584	IRMS HARMONIC 12 [A] MSW	L1	Measurement of the phase IRMS of the i-th harmonic[A]	RO	FLOAT32
40586	585	IRMS HARMONIC 12 [A] LSW			RO	
40587	586	IRMS HARMONIC 12 [A] MSW	L2	Measurement of the phase IRMS of the i-th harmonic[A]	RO	FLOAT32
40588	587	IRMS HARMONIC 12 [A] LSW			RO	
40589	588	IRMS HARMONIC 12 [A] MSW	L3		RO	FLOAT32

ADDRESS (4x)	ADDRESS OFFSET	REGISTER	PHASE	DESCRIPTION	W/R	TYPE
40590	589	IRMS HARMONIC 12 [A] LSW		Measurement of the phase IRMS of the i-th harmonic[A]	RO	
40591	590	IRMS HARMONIC 13 [A] MSW	L1	Measurement of the phase IRMS of the i-th harmonic[A]	RO	FLOAT32
40592	591	IRMS HARMONIC 13 [A] LSW			RO	
40593	592	IRMS HARMONIC 13 [A] MSW	L2	Measurement of the phase IRMS of the i-th harmonic[A]	RO	FLOAT32
40594	593	IRMS HARMONIC 13 [A] LSW			RO	
40595	594	IRMS HARMONIC 13 [A] MSW	L3	Measurement of the phase IRMS of the i-th harmonic[A]	RO	FLOAT32
40596	595	IRMS HARMONIC 13 [A] LSW			RO	
40597	596	IRMS HARMONIC 14 [A] MSW	L1	Measurement of the phase IRMS of the i-th harmonic[A]	RO	FLOAT32
40598	597	IRMS HARMONIC 14 [A] LSW			RO	
40599	598	IRMS HARMONIC 14 [A] MSW	L2	Measurement of the phase IRMS of the i-th harmonic[A]	RO	FLOAT32
40600	599	IRMS HARMONIC 14 [A] LSW			RO	
40601	600	IRMS HARMONIC 14 [A] MSW	L3	Measurement of the phase IRMS of the i-th harmonic[A]	RO	FLOAT32
40602	601	IRMS HARMONIC 14 [A] LSW			RO	
40603	602	IRMS HARMONIC 15 [A] MSW	L1	Measurement of the phase IRMS of the i-th harmonic[A]	RO	FLOAT32
40604	603	IRMS HARMONIC 15 [A] LSW			RO	
40605	604	IRMS HARMONIC 15 [A] MSW	L2	Measurement of the phase IRMS of the i-th harmonic[A]	RO	FLOAT32
40606	605	IRMS HARMONIC 15 [A] LSW			RO	
40607	606	IRMS HARMONIC 15 [A] MSW	L3	Measurement of the phase IRMS of the i-th harmonic[A]	RO	FLOAT32
40608	607	IRMS HARMONIC 15 [A] LSW			RO	
40609	608	IRMS HARMONIC 16 [A] MSW	L1	Measurement of the phase IRMS of the i-th harmonic[A]	RO	FLOAT32
40610	609	IRMS HARMONIC 16 [A] LSW			RO	
40611	610	IRMS HARMONIC 16 [A] MSW	L2	Measurement of the phase IRMS of the i-th harmonic[A]	RO	FLOAT32
40612	611	IRMS HARMONIC 16 [A] LSW			RO	
40613	612	IRMS HARMONIC 16 [A] MSW	L3	Measurement of the phase IRMS of the i-th harmonic[A]	RO	FLOAT32
40614	613	IRMS HARMONIC 16 [A] LSW			RO	
40615	614	IRMS HARMONIC 17 [A] MSW	L1	Measurement of the phase IRMS of the i-th harmonic[A]	RO	FLOAT32
40616	615	IRMS HARMONIC 17 [A] LSW			RO	
40617	616	IRMS HARMONIC 17 [A] MSW	L2	Measurement of the phase IRMS of the i-th harmonic[A]	RO	FLOAT32
40618	617	IRMS HARMONIC 17 [A] LSW			RO	
40619	618	IRMS HARMONIC 17 [A] MSW	L3	Measurement of the phase IRMS of the i-th harmonic[A]	RO	FLOAT32
40620	619	IRMS HARMONIC 17 [A] LSW			RO	
40621	620	IRMS HARMONIC 18 [A] MSW	L1		RO	FLOAT32

ADDRESS (4x)	ADDRESS OFFSET	REGISTER	PHASE	DESCRIPTION	W/R	TYPE
40622	621	IRMS HARMONIC 18 [A] LSW		Measurement of the phase IRMS of the i-th harmonic[A]	RO	
40623	622	IRMS HARMONIC 18 [A] MSW	L2	Measurement of the phase IRMS of the i-th harmonic[A]	RO	FLOAT32
40624	623	IRMS HARMONIC 18 [A] LSW			RO	
40625	624	IRMS HARMONIC 18 [A] MSW	L3	Measurement of the phase IRMS of the i-th harmonic[A]	RO	FLOAT32
40626	625	IRMS HARMONIC 18 [A] LSW			RO	
40627	626	IRMS HARMONIC 19 [A] MSW	L1	Measurement of the phase IRMS of the i-th harmonic[A]	RO	FLOAT32
40628	627	IRMS HARMONIC 19 [A] LSW			RO	
40629	628	IRMS HARMONIC 19 [A] MSW	L2	Measurement of the phase IRMS of the i-th harmonic[A]	RO	FLOAT32
40630	629	IRMS HARMONIC 19 [A] LSW			RO	
40631	630	IRMS HARMONIC 19 [A] MSW	L3	Measurement of the phase IRMS of the i-th harmonic[A]	RO	FLOAT32
40632	631	IRMS HARMONIC 19 [A] LSW			RO	
40633	632	IRMS HARMONIC 20 [A] MSW	L1	Measurement of the phase IRMS of the i-th harmonic[A]	RO	FLOAT32
40634	633	IRMS HARMONIC 20 [A] LSW			RO	
40635	634	IRMS HARMONIC 20 [A] MSW	L2	Measurement of the phase IRMS of the i-th harmonic[A]	RO	FLOAT32
40636	635	IRMS HARMONIC 20 [A] LSW			RO	
40637	636	IRMS HARMONIC 20 [A] MSW	L3	Measurement of the phase IRMS of the i-th harmonic[A]	RO	FLOAT32
40638	637	IRMS HARMONIC 20 [A] LSW			RO	
40639	638	IRMS HARMONIC 21 [A] MSW	L1	Measurement of the phase IRMS of the i-th harmonic[A]	RO	FLOAT32
40640	639	IRMS HARMONIC 21 [A] LSW			RO	
40641	640	IRMS HARMONIC 21 [A] MSW	L2	Measurement of the phase IRMS of the i-th harmonic[A]	RO	FLOAT32
40642	641	IRMS HARMONIC 21 [A] LSW			RO	
40643	642	IRMS HARMONIC 21 [A] MSW	L3	Measurement of the phase IRMS of the i-th harmonic[A]	RO	FLOAT32
40644	643	IRMS HARMONIC 21 [A] LSW			RO	
40645	644	IRMS HARMONIC 22 [A] MSW	L1	Measurement of the phase IRMS of the i-th harmonic[A]	RO	FLOAT32
40646	645	IRMS HARMONIC 22 [A] LSW			RO	
40647	646	IRMS HARMONIC 22 [A] MSW	L2	Measurement of the phase IRMS of the i-th harmonic[A]	RO	FLOAT32
40648	647	IRMS HARMONIC 22 [A] LSW			RO	
40649	648	IRMS HARMONIC 22 [A] MSW	L3	Measurement of the phase IRMS of the i-th harmonic[A]	RO	FLOAT32
40650	649	IRMS HARMONIC 22 [A] LSW			RO	
40651	650	IRMS HARMONIC 23 [A] MSW	L1	Measurement of the phase IRMS of the i-th harmonic[A]	RO	FLOAT32
40652	651	IRMS HARMONIC 23 [A] LSW			RO	
40653	652	IRMS HARMONIC 23 [A] MSW	L2		RO	FLOAT32

ADDRESS (4x)	ADDRESS OFFSET	REGISTER	PHASE	DESCRIPTION	W/R	TYPE
40654	653	IRMS HARMONIC 23 [A] LSW		Measurement of the phase IRMS of the i-th harmonic[A]	RO	
40655	654	IRMS HARMONIC 23 [A] MSW	L3	Measurement of the phase IRMS of the i-th harmonic[A]	RO	FLOAT32
40656	655	IRMS HARMONIC 23 [A] LSW			RO	
40657	656	IRMS HARMONIC 24 [A] MSW	L1	Measurement of the phase IRMS of the i-th harmonic[A]	RO	FLOAT32
40658	657	IRMS HARMONIC 24 [A] LSW			RO	
40659	658	IRMS HARMONIC 24 [A] MSW	L2	Measurement of the phase IRMS of the i-th harmonic[A]	RO	FLOAT32
40660	659	IRMS HARMONIC 24 [A] LSW			RO	
40661	660	IRMS HARMONIC 24 [A] MSW	L3	Measurement of the phase IRMS of the i-th harmonic[A]	RO	FLOAT32
40662	661	IRMS HARMONIC 24 [A] LSW			RO	
40663	662	IRMS HARMONIC 25 [A] MSW	L1	Measurement of the phase IRMS of the i-th harmonic[A]	RO	FLOAT32
40664	663	IRMS HARMONIC 25 [A] LSW			RO	
40665	664	IRMS HARMONIC 25 [A] MSW	L2	Measurement of the phase IRMS of the i-th harmonic[A]	RO	FLOAT32
40666	665	IRMS HARMONIC 25 [A] LSW			RO	
40667	666	IRMS HARMONIC 25 [A] MSW	L3	Measurement of the phase IRMS of the i-th harmonic[A]	RO	FLOAT32
40668	667	IRMS HARMONIC 25 [A] LSW			RO	
40669	668	IRMS HARMONIC 26 [A] MSW	L1	Measurement of the phase IRMS of the i-th harmonic[A]	RO	FLOAT32
40670	669	IRMS HARMONIC 26 [A] LSW			RO	
40671	670	IRMS HARMONIC 26 [A] MSW	L2	Measurement of the phase IRMS of the i-th harmonic[A]	RO	FLOAT32
40672	671	IRMS HARMONIC 26 [A] LSW			RO	
40673	672	IRMS HARMONIC 26 [A] MSW	L3	Measurement of the phase IRMS of the i-th harmonic[A]	RO	FLOAT32
40674	673	IRMS HARMONIC 26 [A] LSW			RO	
40675	674	IRMS HARMONIC 27 [A] MSW	L1	Measurement of the phase IRMS of the i-th harmonic[A]	RO	FLOAT32
40676	675	IRMS HARMONIC 27 [A] LSW			RO	
40677	676	IRMS HARMONIC 27 [A] MSW	L2	Measurement of the phase IRMS of the i-th harmonic[A]	RO	FLOAT32
40678	677	IRMS HARMONIC 27 [A] LSW			RO	
40679	678	IRMS HARMONIC 27 [A] MSW	L3	Measurement of the phase IRMS of the i-th harmonic[A]	RO	FLOAT32
40680	679	IRMS HARMONIC 27 [A] LSW			RO	
40681	680	IRMS HARMONIC 28 [A] MSW	L1	Measurement of the phase IRMS of the i-th harmonic[A]	RO	FLOAT32
40682	681	IRMS HARMONIC 28 [A] LSW			RO	
40683	682	IRMS HARMONIC 28 [A] MSW	L2	Measurement of the phase IRMS of the i-th harmonic[A]	RO	FLOAT32
40684	683	IRMS HARMONIC 28 [A] LSW			RO	
40685	684	IRMS HARMONIC 28 [A] MSW	L3		RO	FLOAT32

ADDRESS (4x)	ADDRESS OFFSET	REGISTER	PHASE	DESCRIPTION	W/R	TYPE
40686	685	IRMS HARMONIC 28 [A] LSW		Measurement of the phase IRMS of the i-th harmonic[A]	RO	
40687	686	IRMS HARMONIC 29 [A] MSW	L1	Measurement of the phase IRMS of the i-th harmonic[A]	RO	FLOAT32
40688	687	IRMS HARMONIC 29 [A] LSW			RO	
40689	688	IRMS HARMONIC 29 [A] MSW	L2	Measurement of the phase IRMS of the i-th harmonic[A]	RO	FLOAT32
40690	689	IRMS HARMONIC 29 [A] LSW			RO	
40691	690	IRMS HARMONIC 29 [A] MSW	L3	Measurement of the phase IRMS of the i-th harmonic[A]	RO	FLOAT32
40692	691	IRMS HARMONIC 29 [A] LSW			RO	
40693	692	IRMS HARMONIC 30 [A] MSW	L1	Measurement of the phase IRMS of the i-th harmonic[A]	RO	FLOAT32
40694	693	IRMS HARMONIC 30 [A] LSW			RO	
40695	694	IRMS HARMONIC 30 [A] MSW	L2	Measurement of the phase IRMS of the i-th harmonic[A]	RO	FLOAT32
40696	695	IRMS HARMONIC 30 [A] LSW			RO	
40697	696	IRMS HARMONIC 30 [A] MSW	L3	Measurement of the phase IRMS of the i-th harmonic[A]	RO	FLOAT32
40698	697	IRMS HARMONIC 30 [A] LSW			RO	
40699	698	IRMS HARMONIC 31 [A] MSW	L1	Measurement of the phase IRMS of the i-th harmonic[A]	RO	FLOAT32
40700	699	IRMS HARMONIC 31 [A] LSW			RO	
40701	700	IRMS HARMONIC 31 [A] MSW	L2	Measurement of the phase IRMS of the i-th harmonic[A]	RO	FLOAT32
40702	701	IRMS HARMONIC 31 [A] LSW			RO	
40703	702	IRMS HARMONIC 31 [A] MSW	L3	Measurement of the phase IRMS of the i-th harmonic[A]	RO	FLOAT32
40704	703	IRMS HARMONIC 31 [A] LSW			RO	
40705	704	IRMS HARMONIC 32 [A] MSW	L1	Measurement of the phase IRMS of the i-th harmonic[A]	RO	FLOAT32
40706	705	IRMS HARMONIC 32 [A] LSW			RO	
40707	706	IRMS HARMONIC 32 [A] MSW	L2	Measurement of the phase IRMS of the i-th harmonic[A]	RO	FLOAT32
40708	707	IRMS HARMONIC 32 [A] LSW			RO	
40709	708	IRMS HARMONIC 32 [A] MSW	L3	Measurement of the phase IRMS of the i-th harmonic[A]	RO	FLOAT32
40710	709	IRMS HARMONIC 32 [A] LSW			RO	
40711	710	IRMS HARMONIC 33 [A] MSW	L1	Measurement of the phase IRMS of the i-th harmonic[A]	RO	FLOAT32
40712	711	IRMS HARMONIC 33 [A] LSW			RO	
40713	712	IRMS HARMONIC 33 [A] MSW	L2	Measurement of the phase IRMS of the i-th harmonic[A]	RO	FLOAT32
40714	713	IRMS HARMONIC 33 [A] LSW			RO	
40715	714	IRMS HARMONIC 33 [A] MSW	L3	Measurement of the phase IRMS of the i-th harmonic[A]	RO	FLOAT32
40716	715	IRMS HARMONIC 33 [A] LSW			RO	
40717	716	IRMS HARMONIC 34 [A] MSW	L1		RO	FLOAT32

ADDRESS (4x)	ADDRESS OFFSET	REGISTER	PHASE	DESCRIPTION	W/R	TYPE
40718	717	IRMS HARMONIC 34 [A] LSW		Measurement of the phase IRMS of the i-th harmonic[A]	RO	
40719	718	IRMS HARMONIC 34 [A] MSW	L2	Measurement of the phase IRMS of the i-th harmonic[A]	RO	FLOAT32
40720	719	IRMS HARMONIC 34 [A] LSW			RO	
40721	720	IRMS HARMONIC 34 [A] MSW	L3	Measurement of the phase IRMS of the i-th harmonic[A]	RO	FLOAT32
40722	721	IRMS HARMONIC 34 [A] LSW			RO	
40723	722	IRMS HARMONIC 35 [A] MSW	L1	Measurement of the phase IRMS of the i-th harmonic[A]	RO	FLOAT32
40724	723	IRMS HARMONIC 35 [A] LSW			RO	
40725	724	IRMS HARMONIC 35 [A] MSW	L2	Measurement of the phase IRMS of the i-th harmonic[A]	RO	FLOAT32
40726	725	IRMS HARMONIC 35 [A] LSW			RO	
40727	726	IRMS HARMONIC 35 [A] MSW	L3	Measurement of the phase IRMS of the i-th harmonic[A]	RO	FLOAT32
40728	727	IRMS HARMONIC 35 [A] LSW			RO	
40729	728	IRMS HARMONIC 36 [A] MSW	L1	Measurement of the phase IRMS of the i-th harmonic[A]	RO	FLOAT32
40730	729	IRMS HARMONIC 36 [A] LSW			RO	
40731	730	IRMS HARMONIC 36 [A] MSW	L2	Measurement of the phase IRMS of the i-th harmonic[A]	RO	FLOAT32
40732	731	IRMS HARMONIC 36 [A] LSW			RO	
40733	732	IRMS HARMONIC 36 [A] MSW	L3	Measurement of the phase IRMS of the i-th harmonic[A]	RO	FLOAT32
40734	733	IRMS HARMONIC 36 [A] LSW			RO	
40735	734	IRMS HARMONIC 37 [A] MSW	L1	Measurement of the phase IRMS of the i-th harmonic[A]	RO	FLOAT32
40736	735	IRMS HARMONIC 37 [A] LSW			RO	
40737	736	IRMS HARMONIC 37 [A] MSW	L2	Measurement of the phase IRMS of the i-th harmonic[A]	RO	FLOAT32
40738	737	IRMS HARMONIC 37 [A] LSW			RO	
40739	738	IRMS HARMONIC 37 [A] MSW	L3	Measurement of the phase IRMS of the i-th harmonic[A]	RO	FLOAT32
40740	739	IRMS HARMONIC 37 [A] LSW			RO	
40741	740	IRMS HARMONIC 38 [A] MSW	L1	Measurement of the phase IRMS of the i-th harmonic[A]	RO	FLOAT32
40742	741	IRMS HARMONIC 38 [A] LSW			RO	
40743	742	IRMS HARMONIC 38 [A] MSW	L2	Measurement of the phase IRMS of the i-th harmonic[A]	RO	FLOAT32
40744	743	IRMS HARMONIC 38 [A] LSW			RO	
40745	744	IRMS HARMONIC 38 [A] MSW	L3	Measurement of the phase IRMS of the i-th harmonic[A]	RO	FLOAT32
40746	745	IRMS HARMONIC 38 [A] LSW			RO	
40747	746	IRMS HARMONIC 39 [A] MSW	L1	Measurement of the phase IRMS of the i-th harmonic[A]	RO	FLOAT32
40748	747	IRMS HARMONIC 39 [A] LSW			RO	
40749	748	IRMS HARMONIC 39 [A] MSW	L2		RO	FLOAT32

ADDRESS (4x)	ADDRESS OFFSET	REGISTER	PHASE	DESCRIPTION	W/R	TYPE
40750	749	IRMS HARMONIC 39 [A] LSW		Measurement of the phase IRMS of the i-th harmonic[A]	RO	
40751	750	IRMS HARMONIC 39 [A] MSW	L3	Measurement of the phase IRMS of the i-th harmonic[A]	RO	FLOAT32
40752	751	IRMS HARMONIC 39 [A] LSW			RO	
40753	752	IRMS HARMONIC 40 [A] MSW	L1	Measurement of the phase IRMS of the i-th harmonic[A]	RO	FLOAT32
40754	753	IRMS HARMONIC 40 [A] LSW			RO	
40755	754	IRMS HARMONIC 40 [A] MSW	L2	Measurement of the phase IRMS of the i-th harmonic[A]	RO	FLOAT32
40756	755	IRMS HARMONIC 40 [A] LSW			RO	
40757	756	IRMS HARMONIC 40 [A] MSW	L3	Measurement of the phase IRMS of the i-th harmonic[A]	RO	FLOAT32
40758	757	IRMS HARMONIC 40 [A] LSW			RO	
40759	758	IRMS HARMONIC 41 [A] MSW	L1	Measurement of the phase IRMS of the i-th harmonic[A]	RO	FLOAT32
40760	759	IRMS HARMONIC 41 [A] LSW			RO	
40761	760	IRMS HARMONIC 41 [A] MSW	L2	Measurement of the phase IRMS of the i-th harmonic[A]	RO	FLOAT32
40762	761	IRMS HARMONIC 41 [A] LSW			RO	
40763	762	IRMS HARMONIC 41 [A] MSW	L3	Measurement of the phase IRMS of the i-th harmonic[A]	RO	FLOAT32
40764	763	IRMS HARMONIC 41 [A] LSW			RO	
40765	764	IRMS HARMONIC 42 [A] MSW	L1	Measurement of the phase IRMS of the i-th harmonic[A]	RO	FLOAT32
40766	765	IRMS HARMONIC 42 [A] LSW			RO	
40767	766	IRMS HARMONIC 42 [A] MSW	L2	Measurement of the phase IRMS of the i-th harmonic[A]	RO	FLOAT32
40768	767	IRMS HARMONIC 42 [A] LSW			RO	
40769	768	IRMS HARMONIC 42 [A] MSW	L3	Measurement of the phase IRMS of the i-th harmonic[A]	RO	FLOAT32
40770	769	IRMS HARMONIC 42 [A] LSW			RO	
40771	770	IRMS HARMONIC 43 [A] MSW	L1	Measurement of the phase IRMS of the i-th harmonic[A]	RO	FLOAT32
40772	771	IRMS HARMONIC 43 [A] LSW			RO	
40773	772	IRMS HARMONIC 43 [A] MSW	L2	Measurement of the phase IRMS of the i-th harmonic[A]	RO	FLOAT32
40774	773	IRMS HARMONIC 43 [A] LSW			RO	
40775	774	IRMS HARMONIC 43 [A] MSW	L3	Measurement of the phase IRMS of the i-th harmonic[A]	RO	FLOAT32
40776	775	IRMS HARMONIC 43 [A] LSW			RO	
40777	776	IRMS HARMONIC 44 [A] MSW	L1	Measurement of the phase IRMS of the i-th harmonic[A]	RO	FLOAT32
40778	777	IRMS HARMONIC 44 [A] LSW			RO	
40779	778	IRMS HARMONIC 44 [A] MSW	L2	Measurement of the phase IRMS of the i-th harmonic[A]	RO	FLOAT32
40780	779	IRMS HARMONIC 44 [A] LSW			RO	
40781	780	IRMS HARMONIC 44 [A] MSW	L3		RO	FLOAT32

ADDRESS (4x)	ADDRESS OFFSET	REGISTER	PHASE	DESCRIPTION	W/R	TYPE
40782	781	IRMS HARMONIC 44 [A] LSW		Measurement of the phase IRMS of the i-th harmonic[A]	RO	
40783	782	IRMS HARMONIC 45 [A] MSW	L1	Measurement of the phase IRMS of the i-th harmonic[A]	RO	FLOAT32
40784	783	IRMS HARMONIC 45 [A] LSW			RO	
40785	784	IRMS HARMONIC 45 [A] MSW	L2	Measurement of the phase IRMS of the i-th harmonic[A]	RO	FLOAT32
40786	785	IRMS HARMONIC 45 [A] LSW			RO	
40787	786	IRMS HARMONIC 45 [A] MSW	L3	Measurement of the phase IRMS of the i-th harmonic[A]	RO	FLOAT32
40788	787	IRMS HARMONIC 45 [A] LSW			RO	
40789	788	IRMS HARMONIC 46 [A] MSW	L1	Measurement of the phase IRMS of the i-th harmonic[A]	RO	FLOAT32
40790	789	IRMS HARMONIC 46 [A] LSW			RO	
40791	790	IRMS HARMONIC 46 [A] MSW	L2	Measurement of the phase IRMS of the i-th harmonic[A]	RO	FLOAT32
40792	791	IRMS HARMONIC 46 [A] LSW			RO	
40793	792	IRMS HARMONIC 46 [A] MSW	L3	Measurement of the phase IRMS of the i-th harmonic[A]	RO	FLOAT32
40794	793	IRMS HARMONIC 46 [A] LSW			RO	
40795	794	IRMS HARMONIC 47 [A] MSW	L1	Measurement of the phase IRMS of the i-th harmonic[A]	RO	FLOAT32
40796	795	IRMS HARMONIC 47 [A] LSW			RO	
40797	796	IRMS HARMONIC 47 [A] MSW	L2	Measurement of the phase IRMS of the i-th harmonic[A]	RO	FLOAT32
40798	797	IRMS HARMONIC 47 [A] LSW			RO	
40799	798	IRMS HARMONIC 47 [A] MSW	L3	Measurement of the phase IRMS of the i-th harmonic[A]	RO	FLOAT32
40800	799	IRMS HARMONIC 47 [A] LSW			RO	
40801	800	IRMS HARMONIC 48 [A] MSW	L1	Measurement of the phase IRMS of the i-th harmonic[A]	RO	FLOAT32
40802	801	IRMS HARMONIC 48 [A] LSW			RO	
40803	802	IRMS HARMONIC 48 [A] MSW	L2	Measurement of the phase IRMS of the i-th harmonic[A]	RO	FLOAT32
40804	803	IRMS HARMONIC 48 [A] LSW			RO	
40805	804	IRMS HARMONIC 48 [A] MSW	L3	Measurement of the phase IRMS of the i-th harmonic[A]	RO	FLOAT32
40806	805	IRMS HARMONIC 48 [A] LSW			RO	
40807	806	IRMS HARMONIC 49 [A] MSW	L1	Measurement of the phase IRMS of the i-th harmonic[A]	RO	FLOAT32
40808	807	IRMS HARMONIC 49 [A] LSW			RO	
40809	808	IRMS HARMONIC 49 [A] MSW	L2	Measurement of the phase IRMS of the i-th harmonic[A]	RO	FLOAT32
40810	809	IRMS HARMONIC 49 [A] LSW			RO	
40811	810	IRMS HARMONIC 49 [A] MSW	L3	Measurement of the phase IRMS of the i-th harmonic[A]	RO	FLOAT32
40812	811	IRMS HARMONIC 49 [A] LSW			RO	
40813	812	IRMS HARMONIC 50 [A] MSW	L1		RO	FLOAT32

ADDRESS (4x)	ADDRESS OFFSET	REGISTER	PHASE	DESCRIPTION	W/R	TYPE
40814	813	IRMS HARMONIC 50 [A] LSW		Measurement of the phase IRMS of the i-th harmonic[A]	RO	
40815	814	IRMS HARMONIC 50 [A] MSW	L2	Measurement of the phase IRMS of the i-th harmonic[A]	RO	FLOAT32
40816	815	IRMS HARMONIC 50 [A] LSW			RO	
40817	816	IRMS HARMONIC 50 [A] MSW	L3	Measurement of the phase IRMS of the i-th harmonic[A]	RO	FLOAT32
40818	817	IRMS HARMONIC 50 [A] LSW			RO	
40819	818	IRMS HARMONIC 51 [A] MSW	L1	Measurement of the phase IRMS of the i-th harmonic[A]	RO	FLOAT32
40820	819	IRMS HARMONIC 51 [A] LSW			RO	
40821	820	IRMS HARMONIC 51 [A] MSW	L2	Measurement of the phase IRMS of the i-th harmonic[A]	RO	FLOAT32
40822	821	IRMS HARMONIC 51 [A] LSW			RO	
40823	822	IRMS HARMONIC 51 [A] MSW	L3	Measurement of the phase IRMS of the i-th harmonic[A]	RO	FLOAT32
40824	823	IRMS HARMONIC 51 [A] LSW			RO	
40825	824	IRMS HARMONIC 52 [A] MSW	L1	Measurement of the phase IRMS of the i-th harmonic[A]	RO	FLOAT32
40826	825	IRMS HARMONIC 52 [A] LSW			RO	
40827	826	IRMS HARMONIC 52 [A] MSW	L2	Measurement of the phase IRMS of the i-th harmonic[A]	RO	FLOAT32
40828	827	IRMS HARMONIC 52 [A] LSW			RO	
40829	828	IRMS HARMONIC 52 [A] MSW	L3	Measurement of the phase IRMS of the i-th harmonic[A]	RO	FLOAT32
40830	829	IRMS HARMONIC 52 [A] LSW			RO	
40831	830	IRMS HARMONIC 53 [A] MSW	L1	Measurement of the phase IRMS of the i-th harmonic[A]	RO	FLOAT32
40832	831	IRMS HARMONIC 53 [A] LSW			RO	
40833	832	IRMS HARMONIC 53 [A] MSW	L2	Measurement of the phase IRMS of the i-th harmonic[A]	RO	FLOAT32
40834	833	IRMS HARMONIC 53 [A] LSW			RO	
40835	834	IRMS HARMONIC 53 [A] MSW	L3	Measurement of the phase IRMS of the i-th harmonic[A]	RO	FLOAT32
40836	835	IRMS HARMONIC 53 [A] LSW			RO	
40837	836	IRMS HARMONIC 54 [A] MSW	L1	Measurement of the phase IRMS of the i-th harmonic[A]	RO	FLOAT32
40838	837	IRMS HARMONIC 54 [A] LSW			RO	
40839	838	IRMS HARMONIC 54 [A] MSW	L2	Measurement of the phase IRMS of the i-th harmonic[A]	RO	FLOAT32
40840	839	IRMS HARMONIC 54 [A] LSW			RO	
40841	840	IRMS HARMONIC 54 [A] MSW	L3	Measurement of the phase IRMS of the i-th harmonic[A]	RO	FLOAT32
40842	841	IRMS HARMONIC 54 [A] LSW			RO	
40843	842	IRMS HARMONIC 55 [A] MSW	L1	Measurement of the phase IRMS of the i-th harmonic[A]	RO	FLOAT32
40844	843	IRMS HARMONIC 55 [A] LSW			RO	
40845	844	IRMS HARMONIC 55 [A] MSW	L2		RO	FLOAT32

ADDRESS (4x)	ADDRESS OFFSET	REGISTER	PHASE	DESCRIPTION	W/R	TYPE
40846	845	IRMS HARMONIC 55 [A] LSW		Measurement of the phase IRMS of the i-th harmonic[A]	RO	
40847	846	IRMS HARMONIC 55 [A] MSW	L3	Measurement of the phase IRMS of the i-th harmonic[A]	RO	FLOAT32
40848	847	IRMS HARMONIC 55 [A] LSW			RO	
40849	848	VRMS HARMONIC 2 [%] MSW	L1-N	Measurement of the Phase - Neutral voltage of the i-th harmonic in comparison with the fundamental [%]	RO	FLOAT32
40850	849	VRMS HARMONIC 2 [%] LSW			RO	
40851	850	VRMS HARMONIC 2 [%] MSW	L2-N	Measurement of the Phase - Neutral voltage of the i-th harmonic in comparison with the fundamental [%]	RO	FLOAT32
40852	851	VRMS HARMONIC 2 [%] LSW			RO	
40853	852	VRMS HARMONIC 2 [%] MSW	L3-N	Measurement of the Phase - Neutral voltage of the i-th harmonic in comparison with the fundamental [%]	RO	FLOAT32
40854	853	VRMS HARMONIC 2 [%] LSW			RO	
40855	854	VRMS HARMONIC 3 [%] MSW	L1-N	Measurement of the Phase - Neutral voltage of the i-th harmonic in comparison with the fundamental [%]	RO	FLOAT32
40856	855	VRMS HARMONIC 3 [%] LSW			RO	
40857	856	VRMS HARMONIC 3 [%] MSW	L2-N	Measurement of the Phase - Neutral voltage of the i-th harmonic in comparison with the fundamental [%]	RO	FLOAT32
40858	857	VRMS HARMONIC 3 [%] LSW			RO	
40859	858	VRMS HARMONIC 3 [%] MSW	L3-N	Measurement of the Phase - Neutral voltage of the i-th harmonic in comparison with the fundamental [%]	RO	FLOAT32
40860	859	VRMS HARMONIC 3 [%] LSW			RO	
40861	860	VRMS HARMONIC 4 [%] MSW	L1-N	Measurement of the Phase - Neutral voltage of the i-th harmonic in comparison with the fundamental [%]	RO	FLOAT32
40862	861	VRMS HARMONIC 4 [%] LSW			RO	
40863	862	VRMS HARMONIC 4 [%] MSW	L2-N	Measurement of the Phase - Neutral voltage of the i-th harmonic in	RO	FLOAT32
40864	863	VRMS HARMONIC 4 [%] LSW			RO	

ADDRESS (4x)	ADDRESS OFFSET	REGISTER	PHASE	DESCRIPTION	W/R	TYPE
				comparison with the fundamental [%]		
40865	864	VRMS HARMONIC 4 [%] MSW	L3-N	Measurement of the Phase - Neutral voltage of the i-th harmonic in comparison with the fundamental [%]	RO	FLOAT32
40866	865	VRMS HARMONIC 4 [%] LSW			RO	
40867	866	VRMS HARMONIC 5 [%] MSW	L1-N	Measurement of the Phase - Neutral voltage of the i-th harmonic in comparison with the fundamental [%]	RO	FLOAT32
40868	867	VRMS HARMONIC 5 [%] LSW			RO	
40869	868	VRMS HARMONIC 5 [%] MSW	L2-N	Measurement of the Phase - Neutral voltage of the i-th harmonic in comparison with the fundamental [%]	RO	FLOAT32
40870	869	VRMS HARMONIC 5 [%] LSW			RO	
40871	870	VRMS HARMONIC 5 [%] MSW	L3-N	Measurement of the Phase - Neutral voltage of the i-th harmonic in comparison with the fundamental [%]	RO	FLOAT32
40872	871	VRMS HARMONIC 5 [%] LSW			RO	
40873	872	VRMS HARMONIC 6 [%] MSW	L1-N	Measurement of the Phase - Neutral voltage of the i-th harmonic in comparison with the fundamental [%]	RO	FLOAT32
40874	873	VRMS HARMONIC 6 [%] LSW			RO	
40875	874	VRMS HARMONIC 6 [%] MSW	L2-N	Measurement of the Phase - Neutral voltage of the i-th harmonic in comparison with the fundamental [%]	RO	FLOAT32
40876	875	VRMS HARMONIC 6 [%] LSW			RO	
40877	876	VRMS HARMONIC 6 [%] MSW	L3-N	Measurement of the Phase - Neutral voltage of the i-th harmonic in comparison with the fundamental [%]	RO	FLOAT32
40878	877	VRMS HARMONIC 6 [%] LSW			RO	
40879	878	VRMS HARMONIC 7 [%] MSW	L1-N	Measurement of the Phase - Neutral voltage of the i-th harmonic in comparison with the fundamental [%]	RO	FLOAT32
40880	879	VRMS HARMONIC 7 [%] LSW			RO	
40881	880	VRMS HARMONIC 7 [%] MSW	L2-N	Measurement of the Phase - Neutral voltage	RO	FLOAT32
40882	881	VRMS HARMONIC 7 [%] LSW			RO	

ADDRESS (4x)	ADDRESS OFFSET	REGISTER	PHASE	DESCRIPTION	W/R	TYPE
				of the i-th harmonic in comparison with the fundamental [%]		
40883	882	VRMS HARMONIC 7 [%] MSW	L3-N	Measurement of the Phase - Neutral voltage of the i-th harmonic in comparison with the fundamental [%]	RO	FLOAT32
40884	883	VRMS HARMONIC 7 [%] LSW			RO	
40885	884	VRMS HARMONIC 8 [%] MSW	L1-N	Measurement of the Phase - Neutral voltage of the i-th harmonic in comparison with the fundamental [%]	RO	FLOAT32
40886	885	VRMS HARMONIC 8 [%] LSW			RO	
40887	886	VRMS HARMONIC 8 [%] MSW	L2-N	Measurement of the Phase - Neutral voltage of the i-th harmonic in comparison with the fundamental [%]	RO	FLOAT32
40888	887	VRMS HARMONIC 8 [%] LSW			RO	
40889	888	VRMS HARMONIC 8 [%] MSW	L3-N	Measurement of the Phase - Neutral voltage of the i-th harmonic in comparison with the fundamental [%]	RO	FLOAT32
40890	889	VRMS HARMONIC 8 [%] LSW			RO	
40891	890	VRMS HARMONIC 9 [%] MSW	L1-N	Measurement of the Phase - Neutral voltage of the i-th harmonic in comparison with the fundamental [%]	RO	FLOAT32
40892	891	VRMS HARMONIC 9 [%] LSW			RO	
40893	892	VRMS HARMONIC 9 [%] MSW	L2-N	Measurement of the Phase - Neutral voltage of the i-th harmonic in comparison with the fundamental [%]	RO	FLOAT32
40894	893	VRMS HARMONIC 9 [%] LSW			RO	
40895	894	VRMS HARMONIC 9 [%] MSW	L3-N	Measurement of the Phase - Neutral voltage of the i-th harmonic in comparison with the fundamental [%]	RO	FLOAT32
40896	895	VRMS HARMONIC 9 [%] LSW			RO	
40897	896	VRMS HARMONIC 10 [%] MSW	L1-N	Measurement of the Phase - Neutral voltage of the i-th harmonic in comparison with the fundamental [%]	RO	FLOAT32
40898	897	VRMS HARMONIC 10 [%] LSW			RO	
40899	898	VRMS HARMONIC 10 [%] MSW	L2-N		RO	FLOAT32

ADDRESS (4x)	ADDRESS OFFSET	REGISTER	PHASE	DESCRIPTION	W/R	TYPE
40900	899	VRMS HARMONIC 10 [%] LSW		Measurement of the Phase - Neutral voltage of the i-th harmonic in comparison with the fundamental [%]	RO	
40901	900	VRMS HARMONIC 10 [%] MSW	L3-N	Measurement of the Phase - Neutral voltage of the i-th harmonic in comparison with the fundamental [%]	RO	FLOAT32
40902	901	VRMS HARMONIC 10 [%] LSW			RO	
40903	902	VRMS HARMONIC 11 [%] MSW	L1-N	Measurement of the Phase - Neutral voltage of the i-th harmonic in comparison with the fundamental [%]	RO	FLOAT32
40904	903	VRMS HARMONIC 11 [%] LSW			RO	
40905	904	VRMS HARMONIC 11 [%] MSW	L2-N	Measurement of the Phase - Neutral voltage of the i-th harmonic in comparison with the fundamental [%]	RO	FLOAT32
40906	905	VRMS HARMONIC 11 [%] LSW			RO	
40907	906	VRMS HARMONIC 11 [%] MSW	L3-N	Measurement of the Phase - Neutral voltage of the i-th harmonic in comparison with the fundamental [%]	RO	FLOAT32
40908	907	VRMS HARMONIC 11 [%] LSW			RO	
40909	908	VRMS HARMONIC 12 [%] MSW	L1-N	Measurement of the Phase - Neutral voltage of the i-th harmonic in comparison with the fundamental [%]	RO	FLOAT32
40910	909	VRMS HARMONIC 12 [%] LSW			RO	
40911	910	VRMS HARMONIC 12 [%] MSW	L2-N	Measurement of the Phase - Neutral voltage of the i-th harmonic in comparison with the fundamental [%]	RO	FLOAT32
40912	911	VRMS HARMONIC 12 [%] LSW			RO	
40913	912	VRMS HARMONIC 12 [%] MSW	L3-N	Measurement of the Phase - Neutral voltage of the i-th harmonic in comparison with the fundamental [%]	RO	FLOAT32
40914	913	VRMS HARMONIC 12 [%] LSW			RO	
40915	914	VRMS HARMONIC 13 [%] MSW	L1-N	Measurement of the Phase - Neutral voltage of the i-th harmonic in	RO	FLOAT32
40916	915	VRMS HARMONIC 13 [%] LSW			RO	

ADDRESS (4x)	ADDRESS OFFSET	REGISTER	PHASE	DESCRIPTION	W/R	TYPE
				comparison with the fundamental [%]		
40917	916	VRMS HARMONIC 13 [%] MSW	L2-N	Measurement of the Phase - Neutral voltage of the i-th harmonic in comparison with the fundamental [%]	RO	FLOAT32
40918	917	VRMS HARMONIC 13 [%] LSW			RO	
40919	918	VRMS HARMONIC 13 [%] MSW	L3-N	Measurement of the Phase - Neutral voltage of the i-th harmonic in comparison with the fundamental [%]	RO	FLOAT32
40920	919	VRMS HARMONIC 13 [%] LSW			RO	
40921	920	VRMS HARMONIC 14 [%] MSW	L1-N	Measurement of the Phase - Neutral voltage of the i-th harmonic in comparison with the fundamental [%]	RO	FLOAT32
40922	921	VRMS HARMONIC 14 [%] LSW			RO	
40923	922	VRMS HARMONIC 14 [%] MSW	L2-N	Measurement of the Phase - Neutral voltage of the i-th harmonic in comparison with the fundamental [%]	RO	FLOAT32
40924	923	VRMS HARMONIC 14 [%] LSW			RO	
40925	924	VRMS HARMONIC 14 [%] MSW	L3-N	Measurement of the Phase - Neutral voltage of the i-th harmonic in comparison with the fundamental [%]	RO	FLOAT32
40926	925	VRMS HARMONIC 14 [%] LSW			RO	
40927	926	VRMS HARMONIC 15 [%] MSW	L1-N	Measurement of the Phase - Neutral voltage of the i-th harmonic in comparison with the fundamental [%]	RO	FLOAT32
40928	927	VRMS HARMONIC 15 [%] LSW			RO	
40929	928	VRMS HARMONIC 15 [%] MSW	L2-N	Measurement of the Phase - Neutral voltage of the i-th harmonic in comparison with the fundamental [%]	RO	FLOAT32
40930	929	VRMS HARMONIC 15 [%] LSW			RO	
40931	930	VRMS HARMONIC 15 [%] MSW	L3-N	Measurement of the Phase - Neutral voltage of the i-th harmonic in comparison with the fundamental [%]	RO	FLOAT32
40932	931	VRMS HARMONIC 15 [%] LSW			RO	
40933	932	VRMS HARMONIC 16 [%] MSW	L1-N	Measurement of the Phase - Neutral voltage	RO	FLOAT32
40934	933	VRMS HARMONIC 16 [%] LSW			RO	

ADDRESS (4x)	ADDRESS OFFSET	REGISTER	PHASE	DESCRIPTION	W/R	TYPE
				of the i-th harmonic in comparison with the fundamental [%]		
40935	934	VRMS HARMONIC 16 [%] MSW	L2-N	Measurement of the Phase - Neutral voltage of the i-th harmonic in comparison with the fundamental [%]	RO	FLOAT32
40936	935	VRMS HARMONIC 16 [%] LSW			RO	
40937	936	VRMS HARMONIC 16 [%] MSW	L3-N	Measurement of the Phase - Neutral voltage of the i-th harmonic in comparison with the fundamental [%]	RO	FLOAT32
40938	937	VRMS HARMONIC 16 [%] LSW			RO	
40939	938	VRMS HARMONIC 17 [%] MSW	L1-N	Measurement of the Phase - Neutral voltage of the i-th harmonic in comparison with the fundamental [%]	RO	FLOAT32
40940	939	VRMS HARMONIC 17 [%] LSW			RO	
40941	940	VRMS HARMONIC 17 [%] MSW	L2-N	Measurement of the Phase - Neutral voltage of the i-th harmonic in comparison with the fundamental [%]	RO	FLOAT32
40942	941	VRMS HARMONIC 17 [%] LSW			RO	
40943	942	VRMS HARMONIC 17 [%] MSW	L3-N	Measurement of the Phase - Neutral voltage of the i-th harmonic in comparison with the fundamental [%]	RO	FLOAT32
40944	943	VRMS HARMONIC 17 [%] LSW			RO	
40945	944	VRMS HARMONIC 18 [%] MSW	L1-N	Measurement of the Phase - Neutral voltage of the i-th harmonic in comparison with the fundamental [%]	RO	FLOAT32
40946	945	VRMS HARMONIC 18 [%] LSW			RO	
40947	946	VRMS HARMONIC 18 [%] MSW	L2-N	Measurement of the Phase - Neutral voltage of the i-th harmonic in comparison with the fundamental [%]	RO	FLOAT32
40948	947	VRMS HARMONIC 18 [%] LSW			RO	
40949	948	VRMS HARMONIC 18 [%] MSW	L3-N	Measurement of the Phase - Neutral voltage of the i-th harmonic in comparison with the fundamental [%]	RO	FLOAT32
40950	949	VRMS HARMONIC 18 [%] LSW			RO	
40951	950	VRMS HARMONIC 19 [%] MSW	L1-N		RO	FLOAT32

ADDRESS (4x)	ADDRESS OFFSET	REGISTER	PHASE	DESCRIPTION	W/R	TYPE
40952	951	VRMS HARMONIC 19 [%] LSW		Measurement of the Phase - Neutral voltage of the i-th harmonic in comparison with the fundamental [%]	RO	
40953	952	VRMS HARMONIC 19 [%] MSW	L2-N	Measurement of the Phase - Neutral voltage of the i-th harmonic in comparison with the fundamental [%]	RO	FLOAT32
40954	953	VRMS HARMONIC 19 [%] LSW			RO	
40955	954	VRMS HARMONIC 19 [%] MSW	L3-N	Measurement of the Phase - Neutral voltage of the i-th harmonic in comparison with the fundamental [%]	RO	FLOAT32
40956	955	VRMS HARMONIC 19 [%] LSW			RO	
40957	956	VRMS HARMONIC 20 [%] MSW	L1-N	Measurement of the Phase - Neutral voltage of the i-th harmonic in comparison with the fundamental [%]	RO	FLOAT32
40958	957	VRMS HARMONIC 20 [%] LSW			RO	
40959	958	VRMS HARMONIC 20 [%] MSW	L2-N	Measurement of the Phase - Neutral voltage of the i-th harmonic in comparison with the fundamental [%]	RO	FLOAT32
40960	959	VRMS HARMONIC 20 [%] LSW			RO	
40961	960	VRMS HARMONIC 20 [%] MSW	L3-N	Measurement of the Phase - Neutral voltage of the i-th harmonic in comparison with the fundamental [%]	RO	FLOAT32
40962	961	VRMS HARMONIC 20 [%] LSW			RO	
40963	962	VRMS HARMONIC 21 [%] MSW	L1-N	Measurement of the Phase - Neutral voltage of the i-th harmonic in comparison with the fundamental [%]	RO	FLOAT32
40964	963	VRMS HARMONIC 21 [%] LSW			RO	
40965	964	VRMS HARMONIC 21 [%] MSW	L2-N	Measurement of the Phase - Neutral voltage of the i-th harmonic in comparison with the fundamental [%]	RO	FLOAT32
40966	965	VRMS HARMONIC 21 [%] LSW			RO	
40967	966	VRMS HARMONIC 21 [%] MSW	L3-N	Measurement of the Phase - Neutral voltage of the i-th harmonic in	RO	FLOAT32
40968	967	VRMS HARMONIC 21 [%] LSW			RO	

ADDRESS (4x)	ADDRESS OFFSET	REGISTER	PHASE	DESCRIPTION	W/R	TYPE
				comparison with the fundamental [%]		
40969	968	VRMS HARMONIC 22 [%] MSW	L1-N	Measurement of the Phase - Neutral voltage of the i-th harmonic in comparison with the fundamental [%]	RO	FLOAT32
40970	969	VRMS HARMONIC 22 [%] LSW			RO	
40971	970	VRMS HARMONIC 22 [%] MSW	L2-N	Measurement of the Phase - Neutral voltage of the i-th harmonic in comparison with the fundamental [%]	RO	FLOAT32
40972	971	VRMS HARMONIC 22 [%] LSW			RO	
40973	972	VRMS HARMONIC 22 [%] MSW	L3-N	Measurement of the Phase - Neutral voltage of the i-th harmonic in comparison with the fundamental [%]	RO	FLOAT32
40974	973	VRMS HARMONIC 22 [%] LSW			RO	
40975	974	VRMS HARMONIC 23 [%] MSW	L1-N	Measurement of the Phase - Neutral voltage of the i-th harmonic in comparison with the fundamental [%]	RO	FLOAT32
40976	975	VRMS HARMONIC 23 [%] LSW			RO	
40977	976	VRMS HARMONIC 23 [%] MSW	L2-N	Measurement of the Phase - Neutral voltage of the i-th harmonic in comparison with the fundamental [%]	RO	FLOAT32
40978	977	VRMS HARMONIC 23 [%] LSW			RO	
40979	978	VRMS HARMONIC 23 [%] MSW	L3-N	Measurement of the Phase - Neutral voltage of the i-th harmonic in comparison with the fundamental [%]	RO	FLOAT32
40980	979	VRMS HARMONIC 23 [%] LSW			RO	
40981	980	VRMS HARMONIC 24 [%] MSW	L1-N	Measurement of the Phase - Neutral voltage of the i-th harmonic in comparison with the fundamental [%]	RO	FLOAT32
40982	981	VRMS HARMONIC 24 [%] LSW			RO	
40983	982	VRMS HARMONIC 24 [%] MSW	L2-N	Measurement of the Phase - Neutral voltage of the i-th harmonic in comparison with the fundamental [%]	RO	FLOAT32
40984	983	VRMS HARMONIC 24 [%] LSW			RO	
40985	984	VRMS HARMONIC 24 [%] MSW	L3-N	Measurement of the Phase - Neutral voltage	RO	FLOAT32
40986	985	VRMS HARMONIC 24 [%] LSW			RO	

ADDRESS (4x)	ADDRESS OFFSET	REGISTER	PHASE	DESCRIPTION	W/R	TYPE
				of the i-th harmonic in comparison with the fundamental [%]		
40987	986	VRMS HARMONIC 25 [%] MSW	L1-N	Measurement of the Phase - Neutral voltage of the i-th harmonic in comparison with the fundamental [%]	RO	FLOAT32
40988	987	VRMS HARMONIC 25 [%] LSW			RO	
40989	988	VRMS HARMONIC 25 [%] MSW	L2-N	Measurement of the Phase - Neutral voltage of the i-th harmonic in comparison with the fundamental [%]	RO	FLOAT32
40990	989	VRMS HARMONIC 25 [%] LSW			RO	
40991	990	VRMS HARMONIC 25 [%] MSW	L3-N	Measurement of the Phase - Neutral voltage of the i-th harmonic in comparison with the fundamental [%]	RO	FLOAT32
40992	991	VRMS HARMONIC 25 [%] LSW			RO	
40993	992	VRMS HARMONIC 26 [%] MSW	L1-N	Measurement of the Phase - Neutral voltage of the i-th harmonic in comparison with the fundamental [%]	RO	FLOAT32
40994	993	VRMS HARMONIC 26 [%] LSW			RO	
40995	994	VRMS HARMONIC 26 [%] MSW	L2-N	Measurement of the Phase - Neutral voltage of the i-th harmonic in comparison with the fundamental [%]	RO	FLOAT32
40996	995	VRMS HARMONIC 26 [%] LSW			RO	
40997	996	VRMS HARMONIC 26 [%] MSW	L3-N	Measurement of the Phase - Neutral voltage of the i-th harmonic in comparison with the fundamental [%]	RO	FLOAT32
40998	997	VRMS HARMONIC 26 [%] LSW			RO	
40999	998	VRMS HARMONIC 27 [%] MSW	L1-N	Measurement of the Phase - Neutral voltage of the i-th harmonic in comparison with the fundamental [%]	RO	FLOAT32
41000	999	VRMS HARMONIC 27 [%] LSW			RO	
41001	1000	VRMS HARMONIC 27 [%] MSW	L2-N	Measurement of the Phase - Neutral voltage of the i-th harmonic in comparison with the fundamental [%]	RO	FLOAT32
41002	1001	VRMS HARMONIC 27 [%] LSW			RO	
41003	1002	VRMS HARMONIC 27 [%] MSW	L3-N		RO	FLOAT32

ADDRESS (4x)	ADDRESS OFFSET	REGISTER	PHASE	DESCRIPTION	W/R	TYPE
41004	1003	VRMS HARMONIC 27 [%] LSW		Measurement of the Phase - Neutral voltage of the i-th harmonic in comparison with the fundamental [%]	RO	
41005	1004	VRMS HARMONIC 28 [%] MSW	L1-N	Measurement of the Phase - Neutral voltage of the i-th harmonic in comparison with the fundamental [%]	RO	FLOAT32
41006	1005	VRMS HARMONIC 28 [%] LSW			RO	
41007	1006	VRMS HARMONIC 28 [%] MSW	L2-N	Measurement of the Phase - Neutral voltage of the i-th harmonic in comparison with the fundamental [%]	RO	FLOAT32
41008	1007	VRMS HARMONIC 28 [%] LSW			RO	
41009	1008	VRMS HARMONIC 28 [%] MSW	L3-N	Measurement of the Phase - Neutral voltage of the i-th harmonic in comparison with the fundamental [%]	RO	FLOAT32
41010	1009	VRMS HARMONIC 28 [%] LSW			RO	
41011	1010	VRMS HARMONIC 29 [%] MSW	L1-N	Measurement of the Phase - Neutral voltage of the i-th harmonic in comparison with the fundamental [%]	RO	FLOAT32
41012	1011	VRMS HARMONIC 29 [%] LSW			RO	
41013	1012	VRMS HARMONIC 29 [%] MSW	L2-N	Measurement of the Phase - Neutral voltage of the i-th harmonic in comparison with the fundamental [%]	RO	FLOAT32
41014	1013	VRMS HARMONIC 29 [%] LSW			RO	
41015	1014	VRMS HARMONIC 29 [%] MSW	L3-N	Measurement of the Phase - Neutral voltage of the i-th harmonic in comparison with the fundamental [%]	RO	FLOAT32
41016	1015	VRMS HARMONIC 29 [%] LSW			RO	
41017	1016	VRMS HARMONIC 30 [%] MSW	L1-N	Measurement of the Phase - Neutral voltage of the i-th harmonic in comparison with the fundamental [%]	RO	FLOAT32
41018	1017	VRMS HARMONIC 30 [%] LSW			RO	
41019	1018	VRMS HARMONIC 30 [%] MSW	L2-N	Measurement of the Phase - Neutral voltage of the i-th harmonic in	RO	FLOAT32
41020	1019	VRMS HARMONIC 30 [%] LSW			RO	

ADDRESS (4x)	ADDRESS OFFSET	REGISTER	PHASE	DESCRIPTION	W/R	TYPE
				comparison with the fundamental [%]		
41021	1020	VRMS HARMONIC 30 [%] MSW	L3-N	Measurement of the Phase - Neutral voltage of the i-th harmonic in comparison with the fundamental [%]	RO	FLOAT32
41022	1021	VRMS HARMONIC 30 [%] LSW			RO	
41023	1022	VRMS HARMONIC 31 [%] MSW	L1-N	Measurement of the Phase - Neutral voltage of the i-th harmonic in comparison with the fundamental [%]	RO	FLOAT32
41024	1023	VRMS HARMONIC 31 [%] LSW			RO	
41025	1024	VRMS HARMONIC 31 [%] MSW	L2-N	Measurement of the Phase - Neutral voltage of the i-th harmonic in comparison with the fundamental [%]	RO	FLOAT32
41026	1025	VRMS HARMONIC 31 [%] LSW			RO	
41027	1026	VRMS HARMONIC 31 [%] MSW	L3-N	Measurement of the Phase - Neutral voltage of the i-th harmonic in comparison with the fundamental [%]	RO	FLOAT32
41028	1027	VRMS HARMONIC 31 [%] LSW			RO	
41029	1028	VRMS HARMONIC 32 [%] MSW	L1-N	Measurement of the Phase - Neutral voltage of the i-th harmonic in comparison with the fundamental [%]	RO	FLOAT32
41030	1029	VRMS HARMONIC 32 [%] LSW			RO	
41031	1030	VRMS HARMONIC 32 [%] MSW	L2-N	Measurement of the Phase - Neutral voltage of the i-th harmonic in comparison with the fundamental [%]	RO	FLOAT32
41032	1031	VRMS HARMONIC 32 [%] LSW			RO	
41033	1032	VRMS HARMONIC 32 [%] MSW	L3-N	Measurement of the Phase - Neutral voltage of the i-th harmonic in comparison with the fundamental [%]	RO	FLOAT32
41034	1033	VRMS HARMONIC 32 [%] LSW			RO	
41035	1034	VRMS HARMONIC 33 [%] MSW	L1-N	Measurement of the Phase - Neutral voltage of the i-th harmonic in comparison with the fundamental [%]	RO	FLOAT32
41036	1035	VRMS HARMONIC 33 [%] LSW			RO	
41037	1036	VRMS HARMONIC 33 [%] MSW	L2-N	Measurement of the Phase - Neutral voltage	RO	FLOAT32
41038	1037	VRMS HARMONIC 33 [%] LSW			RO	

ADDRESS (4x)	ADDRESS OFFSET	REGISTER	PHASE	DESCRIPTION	W/R	TYPE
				of the i-th harmonic in comparison with the fundamental [%]		
41039	1038	VRMS HARMONIC 33 [%] MSW	L3-N	Measurement of the Phase - Neutral voltage of the i-th harmonic in comparison with the fundamental [%]	RO	FLOAT32
41040	1039	VRMS HARMONIC 33 [%] LSW			RO	
41041	1040	VRMS HARMONIC 34 [%] MSW	L1-N	Measurement of the Phase - Neutral voltage of the i-th harmonic in comparison with the fundamental [%]	RO	FLOAT32
41042	1041	VRMS HARMONIC 34 [%] LSW			RO	
41043	1042	VRMS HARMONIC 34 [%] MSW	L2-N	Measurement of the Phase - Neutral voltage of the i-th harmonic in comparison with the fundamental [%]	RO	FLOAT32
41044	1043	VRMS HARMONIC 34 [%] LSW			RO	
41045	1044	VRMS HARMONIC 34 [%] MSW	L3-N	Measurement of the Phase - Neutral voltage of the i-th harmonic in comparison with the fundamental [%]	RO	FLOAT32
41046	1045	VRMS HARMONIC 34 [%] LSW			RO	
41047	1046	VRMS HARMONIC 35 [%] MSW	L1-N	Measurement of the Phase - Neutral voltage of the i-th harmonic in comparison with the fundamental [%]	RO	FLOAT32
41048	1047	VRMS HARMONIC 35 [%] LSW			RO	
41049	1048	VRMS HARMONIC 35 [%] MSW	L2-N	Measurement of the Phase - Neutral voltage of the i-th harmonic in comparison with the fundamental [%]	RO	FLOAT32
41050	1049	VRMS HARMONIC 35 [%] LSW			RO	
41051	1050	VRMS HARMONIC 35 [%] MSW	L3-N	Measurement of the Phase - Neutral voltage of the i-th harmonic in comparison with the fundamental [%]	RO	FLOAT32
41052	1051	VRMS HARMONIC 35 [%] LSW			RO	
41053	1052	VRMS HARMONIC 36 [%] MSW	L1-N	Measurement of the Phase - Neutral voltage of the i-th harmonic in comparison with the fundamental [%]	RO	FLOAT32
41054	1053	VRMS HARMONIC 36 [%] LSW			RO	
41055	1054	VRMS HARMONIC 36 [%] MSW	L2-N		RO	FLOAT32

ADDRESS (4x)	ADDRESS OFFSET	REGISTER	PHASE	DESCRIPTION	W/R	TYPE
41056	1055	VRMS HARMONIC 36 [%] LSW		Measurement of the Phase - Neutral voltage of the i-th harmonic in comparison with the fundamental [%]	RO	
41057	1056	VRMS HARMONIC 36 [%] MSW	L3-N	Measurement of the Phase - Neutral voltage of the i-th harmonic in comparison with the fundamental [%]	RO	FLOAT32
41058	1057	VRMS HARMONIC 36 [%] LSW			RO	
41059	1058	VRMS HARMONIC 37 [%] MSW	L1-N	Measurement of the Phase - Neutral voltage of the i-th harmonic in comparison with the fundamental [%]	RO	FLOAT32
41060	1059	VRMS HARMONIC 37 [%] LSW			RO	
41061	1060	VRMS HARMONIC 37 [%] MSW	L2-N	Measurement of the Phase - Neutral voltage of the i-th harmonic in comparison with the fundamental [%]	RO	FLOAT32
41062	1061	VRMS HARMONIC 37 [%] LSW			RO	
41063	1062	VRMS HARMONIC 37 [%] MSW	L3-N	Measurement of the Phase - Neutral voltage of the i-th harmonic in comparison with the fundamental [%]	RO	FLOAT32
41064	1063	VRMS HARMONIC 37 [%] LSW			RO	
41065	1064	VRMS HARMONIC 38 [%] MSW	L1-N	Measurement of the Phase - Neutral voltage of the i-th harmonic in comparison with the fundamental [%]	RO	FLOAT32
41066	1065	VRMS HARMONIC 38 [%] LSW			RO	
41067	1066	VRMS HARMONIC 38 [%] MSW	L2-N	Measurement of the Phase - Neutral voltage of the i-th harmonic in comparison with the fundamental [%]	RO	FLOAT32
41068	1067	VRMS HARMONIC 38 [%] LSW			RO	
41069	1068	VRMS HARMONIC 38 [%] MSW	L3-N	Measurement of the Phase - Neutral voltage of the i-th harmonic in comparison with the fundamental [%]	RO	FLOAT32
41070	1069	VRMS HARMONIC 38 [%] LSW			RO	
41071	1070	VRMS HARMONIC 39 [%] MSW	L1-N	Measurement of the Phase - Neutral voltage of the i-th harmonic in	RO	FLOAT32
41072	1071	VRMS HARMONIC 39 [%] LSW			RO	

ADDRESS (4x)	ADDRESS OFFSET	REGISTER	PHASE	DESCRIPTION	W/R	TYPE
				comparison with the fundamental [%]		
41073	1072	VRMS HARMONIC 39 [%] MSW	L2-N	Measurement of the Phase - Neutral voltage of the i-th harmonic in comparison with the fundamental [%]	RO	FLOAT32
41074	1073	VRMS HARMONIC 39 [%] LSW			RO	
41075	1074	VRMS HARMONIC 39 [%] MSW	L3-N	Measurement of the Phase - Neutral voltage of the i-th harmonic in comparison with the fundamental [%]	RO	FLOAT32
41076	1075	VRMS HARMONIC 39 [%] LSW			RO	
41077	1076	VRMS HARMONIC 40 [%] MSW	L1-N	Measurement of the Phase - Neutral voltage of the i-th harmonic in comparison with the fundamental [%]	RO	FLOAT32
41078	1077	VRMS HARMONIC 40 [%] LSW			RO	
41079	1078	VRMS HARMONIC 40 [%] MSW	L2-N	Measurement of the Phase - Neutral voltage of the i-th harmonic in comparison with the fundamental [%]	RO	FLOAT32
41080	1079	VRMS HARMONIC 40 [%] LSW			RO	
41081	1080	VRMS HARMONIC 40 [%] MSW	L3-N	Measurement of the Phase - Neutral voltage of the i-th harmonic in comparison with the fundamental [%]	RO	FLOAT32
41082	1081	VRMS HARMONIC 40 [%] LSW			RO	
41083	1082	VRMS HARMONIC 41 [%] MSW	L1-N	Measurement of the Phase - Neutral voltage of the i-th harmonic in comparison with the fundamental [%]	RO	FLOAT32
41084	1083	VRMS HARMONIC 41 [%] LSW			RO	
41085	1084	VRMS HARMONIC 41 [%] MSW	L2-N	Measurement of the Phase - Neutral voltage of the i-th harmonic in comparison with the fundamental [%]	RO	FLOAT32
41086	1085	VRMS HARMONIC 41 [%] LSW			RO	
41087	1086	VRMS HARMONIC 41 [%] MSW	L3-N	Measurement of the Phase - Neutral voltage of the i-th harmonic in comparison with the fundamental [%]	RO	FLOAT32
41088	1087	VRMS HARMONIC 41 [%] LSW			RO	
41089	1088	VRMS HARMONIC 42 [%] MSW	L1-N	Measurement of the Phase - Neutral voltage	RO	FLOAT32
41090	1089	VRMS HARMONIC 42 [%] LSW			RO	

ADDRESS (4x)	ADDRESS OFFSET	REGISTER	PHASE	DESCRIPTION	W/R	TYPE
				of the i-th harmonic in comparison with the fundamental [%]		
41091	1090	VRMS HARMONIC 42 [%] MSW	L2-N	Measurement of the Phase - Neutral voltage of the i-th harmonic in comparison with the fundamental [%]	RO	FLOAT32
41092	1091	VRMS HARMONIC 42 [%] LSW			RO	
41093	1092	VRMS HARMONIC 42 [%] MSW	L3-N	Measurement of the Phase - Neutral voltage of the i-th harmonic in comparison with the fundamental [%]	RO	FLOAT32
41094	1093	VRMS HARMONIC 42 [%] LSW			RO	
41095	1094	VRMS HARMONIC 43 [%] MSW	L1-N	Measurement of the Phase - Neutral voltage of the i-th harmonic in comparison with the fundamental [%]	RO	FLOAT32
41096	1095	VRMS HARMONIC 43 [%] LSW			RO	
41097	1096	VRMS HARMONIC 43 [%] MSW	L2-N	Measurement of the Phase - Neutral voltage of the i-th harmonic in comparison with the fundamental [%]	RO	FLOAT32
41098	1097	VRMS HARMONIC 43 [%] LSW			RO	
41099	1098	VRMS HARMONIC 43 [%] MSW	L3-N	Measurement of the Phase - Neutral voltage of the i-th harmonic in comparison with the fundamental [%]	RO	FLOAT32
41100	1099	VRMS HARMONIC 43 [%] LSW			RO	
41101	1100	VRMS HARMONIC 44 [%] MSW	L1-N	Measurement of the Phase - Neutral voltage of the i-th harmonic in comparison with the fundamental [%]	RO	FLOAT32
41102	1101	VRMS HARMONIC 44 [%] LSW			RO	
41103	1102	VRMS HARMONIC 44 [%] MSW	L2-N	Measurement of the Phase - Neutral voltage of the i-th harmonic in comparison with the fundamental [%]	RO	FLOAT32
41104	1103	VRMS HARMONIC 44 [%] LSW			RO	
41105	1104	VRMS HARMONIC 44 [%] MSW	L3-N	Measurement of the Phase - Neutral voltage of the i-th harmonic in comparison with the fundamental [%]	RO	FLOAT32
41106	1105	VRMS HARMONIC 44 [%] LSW			RO	
41107	1106	VRMS HARMONIC 45 [%] MSW	L1-N		RO	FLOAT32

ADDRESS (4x)	ADDRESS OFFSET	REGISTER	PHASE	DESCRIPTION	W/R	TYPE
41108	1107	VRMS HARMONIC 45 [%] LSW		Measurement of the Phase - Neutral voltage of the i-th harmonic in comparison with the fundamental [%]	RO	
41109	1108	VRMS HARMONIC 45 [%] MSW	L2-N	Measurement of the Phase - Neutral voltage of the i-th harmonic in comparison with the fundamental [%]	RO	FLOAT32
41110	1109	VRMS HARMONIC 45 [%] LSW			RO	
41111	1110	VRMS HARMONIC 45 [%] MSW	L3-N	Measurement of the Phase - Neutral voltage of the i-th harmonic in comparison with the fundamental [%]	RO	FLOAT32
41112	1111	VRMS HARMONIC 45 [%] LSW			RO	
41113	1112	VRMS HARMONIC 46 [%] MSW	L1-N	Measurement of the Phase - Neutral voltage of the i-th harmonic in comparison with the fundamental [%]	RO	FLOAT32
41114	1113	VRMS HARMONIC 46 [%] LSW			RO	
41115	1114	VRMS HARMONIC 46 [%] MSW	L2-N	Measurement of the Phase - Neutral voltage of the i-th harmonic in comparison with the fundamental [%]	RO	FLOAT32
41116	1115	VRMS HARMONIC 46 [%] LSW			RO	
41117	1116	VRMS HARMONIC 46 [%] MSW	L3-N	Measurement of the Phase - Neutral voltage of the i-th harmonic in comparison with the fundamental [%]	RO	FLOAT32
41118	1117	VRMS HARMONIC 46 [%] LSW			RO	
41119	1118	VRMS HARMONIC 47 [%] MSW	L1-N	Measurement of the Phase - Neutral voltage of the i-th harmonic in comparison with the fundamental [%]	RO	FLOAT32
41120	1119	VRMS HARMONIC 47 [%] LSW			RO	
41121	1120	VRMS HARMONIC 47 [%] MSW	L2-N	Measurement of the Phase - Neutral voltage of the i-th harmonic in comparison with the fundamental [%]	RO	FLOAT32
41122	1121	VRMS HARMONIC 47 [%] LSW			RO	
41123	1122	VRMS HARMONIC 47 [%] MSW	L3-N	Measurement of the Phase - Neutral voltage of the i-th harmonic in	RO	FLOAT32
41124	1123	VRMS HARMONIC 47 [%] LSW			RO	

ADDRESS (4x)	ADDRESS OFFSET	REGISTER	PHASE	DESCRIPTION	W/R	TYPE
				comparison with the fundamental [%]		
41125	1124	VRMS HARMONIC 48 [%] MSW	L1-N	Measurement of the Phase - Neutral voltage of the i-th harmonic in comparison with the fundamental [%]	RO	FLOAT32
41126	1125	VRMS HARMONIC 48 [%] LSW			RO	
41127	1126	VRMS HARMONIC 48 [%] MSW	L2-N	Measurement of the Phase - Neutral voltage of the i-th harmonic in comparison with the fundamental [%]	RO	FLOAT32
41128	1127	VRMS HARMONIC 48 [%] LSW			RO	
41129	1128	VRMS HARMONIC 48 [%] MSW	L3-N	Measurement of the Phase - Neutral voltage of the i-th harmonic in comparison with the fundamental [%]	RO	FLOAT32
41130	1129	VRMS HARMONIC 48 [%] LSW			RO	
41131	1130	VRMS HARMONIC 49 [%] MSW	L1-N	Measurement of the Phase - Neutral voltage of the i-th harmonic in comparison with the fundamental [%]	RO	FLOAT32
41132	1131	VRMS HARMONIC 49 [%] LSW			RO	
41133	1132	VRMS HARMONIC 49 [%] MSW	L2-N	Measurement of the Phase - Neutral voltage of the i-th harmonic in comparison with the fundamental [%]	RO	FLOAT32
41134	1133	VRMS HARMONIC 49 [%] LSW			RO	
41135	1134	VRMS HARMONIC 49 [%] MSW	L3-N	Measurement of the Phase - Neutral voltage of the i-th harmonic in comparison with the fundamental [%]	RO	FLOAT32
41136	1135	VRMS HARMONIC 49 [%] LSW			RO	
41137	1136	VRMS HARMONIC 50 [%] MSW	L1-N	Measurement of the Phase - Neutral voltage of the i-th harmonic in comparison with the fundamental [%]	RO	FLOAT32
41138	1137	VRMS HARMONIC 50 [%] LSW			RO	
41139	1138	VRMS HARMONIC 50 [%] MSW	L2-N	Measurement of the Phase - Neutral voltage of the i-th harmonic in comparison with the fundamental [%]	RO	FLOAT32
41140	1139	VRMS HARMONIC 50 [%] LSW			RO	
41141	1140	VRMS HARMONIC 50 [%] MSW	L3-N	Measurement of the Phase - Neutral voltage	RO	FLOAT32
41142	1141	VRMS HARMONIC 50 [%] LSW			RO	

ADDRESS (4x)	ADDRESS OFFSET	REGISTER	PHASE	DESCRIPTION	W/R	TYPE
				of the i-th harmonic in comparison with the fundamental [%]		
41143	1142	VRMS HARMONIC 51 [%] MSW	L1-N	Measurement of the Phase - Neutral voltage of the i-th harmonic in comparison with the fundamental [%]	RO	FLOAT32
41144	1143	VRMS HARMONIC 51 [%] LSW			RO	
41145	1144	VRMS HARMONIC 51 [%] MSW	L2-N	Measurement of the Phase - Neutral voltage of the i-th harmonic in comparison with the fundamental [%]	RO	FLOAT32
41146	1145	VRMS HARMONIC 51 [%] LSW			RO	
41147	1146	VRMS HARMONIC 51 [%] MSW	L3-N	Measurement of the Phase - Neutral voltage of the i-th harmonic in comparison with the fundamental [%]	RO	FLOAT32
41148	1147	VRMS HARMONIC 51 [%] LSW			RO	
41149	1148	VRMS HARMONIC 52 [%] MSW	L1-N	Measurement of the Phase - Neutral voltage of the i-th harmonic in comparison with the fundamental [%]	RO	FLOAT32
41150	1149	VRMS HARMONIC 52 [%] LSW			RO	
41151	1150	VRMS HARMONIC 52 [%] MSW	L2-N	Measurement of the Phase - Neutral voltage of the i-th harmonic in comparison with the fundamental [%]	RO	FLOAT32
41152	1151	VRMS HARMONIC 52 [%] LSW			RO	
41153	1152	VRMS HARMONIC 52 [%] MSW	L3-N	Measurement of the Phase - Neutral voltage of the i-th harmonic in comparison with the fundamental [%]	RO	FLOAT32
41154	1153	VRMS HARMONIC 52 [%] LSW			RO	
41155	1154	VRMS HARMONIC 53 [%] MSW	L1-N	Measurement of the Phase - Neutral voltage of the i-th harmonic in comparison with the fundamental [%]	RO	FLOAT32
41156	1155	VRMS HARMONIC 53 [%] LSW			RO	
41157	1156	VRMS HARMONIC 53 [%] MSW	L2-N	Measurement of the Phase - Neutral voltage of the i-th harmonic in comparison with the fundamental [%]	RO	FLOAT32
41158	1157	VRMS HARMONIC 53 [%] LSW			RO	

ADDRESS (4x)	ADDRESS OFFSET	REGISTER	PHASE	DESCRIPTION	W/R	TYPE
41159	1158	VRMS HARMONIC 53 [%] MSW	L3-N	Measurement of the Phase - Neutral voltage of the i-th harmonic in comparison with the fundamental [%]	RO	FLOAT32
41160	1159	VRMS HARMONIC 53 [%] LSW			RO	
41161	1160	VRMS HARMONIC 54 [%] MSW	L1-N	Measurement of the Phase - Neutral voltage of the i-th harmonic in comparison with the fundamental [%]	RO	FLOAT32
41162	1161	VRMS HARMONIC 54 [%] LSW			RO	
41163	1162	VRMS HARMONIC 54 [%] MSW	L2-N	Measurement of the Phase - Neutral voltage of the i-th harmonic in comparison with the fundamental [%]	RO	FLOAT32
41164	1163	VRMS HARMONIC 54 [%] LSW			RO	
41165	1164	VRMS HARMONIC 54 [%] MSW	L3-N	Measurement of the Phase - Neutral voltage of the i-th harmonic in comparison with the fundamental [%]	RO	FLOAT32
41166	1165	VRMS HARMONIC 54 [%] LSW			RO	
41167	1166	VRMS HARMONIC 55 [%] MSW	L1-N	Measurement of the Phase - Neutral voltage of the i-th harmonic in comparison with the fundamental [%]	RO	FLOAT32
41168	1167	VRMS HARMONIC 55 [%] LSW			RO	
41169	1168	VRMS HARMONIC 55 [%] MSW	L2-N	Measurement of the Phase - Neutral voltage of the i-th harmonic in comparison with the fundamental [%]	RO	FLOAT32
41170	1169	VRMS HARMONIC 55 [%] LSW			RO	
41171	1170	VRMS HARMONIC 55 [%] MSW	L3-N	Measurement of the Phase - Neutral voltage of the i-th harmonic in comparison with the fundamental [%]	RO	FLOAT32
41172	1171	VRMS HARMONIC 55 [%] LSW			RO	
41173	1172	IRMS HARMONIC 2 [%] MSW	L1	Measurement of the Phase - Neutral current of the i-th harmonic in comparison with the fundamental [%]	RO	FLOAT32
41174	1173	IRMS HARMONIC 2 [%] LSW			RO	
41175	1174	IRMS HARMONIC 2 [%] MSW	L2	Measurement of the Phase - Neutral current of the i-th harmonic in	RO	FLOAT32
41176	1175	IRMS HARMONIC 2 [%] LSW			RO	

ADDRESS (4x)	ADDRESS OFFSET	REGISTER	PHASE	DESCRIPTION	W/R	TYPE
				comparison with the fundamental [%]		
41177	1176	IRMS HARMONIC 2 [%] MSW	L3	Measurement of the Phase - Neutral current of the i-th harmonic in comparison with the fundamental [%]	RO	FLOAT32
41178	1177	IRMS HARMONIC 2 [%] LSW			RO	
41179	1178	IRMS HARMONIC 3 [%] MSW	L1	Measurement of the Phase - Neutral current of the i-th harmonic in comparison with the fundamental [%]	RO	FLOAT32
41180	1179	IRMS HARMONIC 3 [%] LSW			RO	
41181	1180	IRMS HARMONIC 3 [%] MSW	L2	Measurement of the Phase - Neutral current of the i-th harmonic in comparison with the fundamental [%]	RO	FLOAT32
41182	1181	IRMS HARMONIC 3 [%] LSW			RO	
41183	1182	IRMS HARMONIC 3 [%] MSW	L3	Measurement of the Phase - Neutral current of the i-th harmonic in comparison with the fundamental [%]	RO	FLOAT32
41184	1183	IRMS HARMONIC 3 [%] LSW			RO	
41185	1184	IRMS HARMONIC 4 [%] MSW	L1	Measurement of the Phase - Neutral current of the i-th harmonic in comparison with the fundamental [%]	RO	FLOAT32
41186	1185	IRMS HARMONIC 4 [%] LSW			RO	
41187	1186	IRMS HARMONIC 4 [%] MSW	L2	Measurement of the Phase - Neutral current of the i-th harmonic in comparison with the fundamental [%]	RO	FLOAT32
41188	1187	IRMS HARMONIC 4 [%] LSW			RO	
41189	1188	IRMS HARMONIC 4 [%] MSW	L3	Measurement of the Phase - Neutral current of the i-th harmonic in comparison with the fundamental [%]	RO	FLOAT32
41190	1189	IRMS HARMONIC 4 [%] LSW			RO	
41191	1190	IRMS HARMONIC 5 [%] MSW	L1	Measurement of the Phase - Neutral current of the i-th harmonic in comparison with the fundamental [%]	RO	FLOAT32
41192	1191	IRMS HARMONIC 5 [%] LSW			RO	
41193	1192	IRMS HARMONIC 5 [%] MSW	L2	Measurement of the Phase - Neutral current	RO	FLOAT32
41194	1193	IRMS HARMONIC 5 [%] LSW			RO	

ADDRESS (4x)	ADDRESS OFFSET	REGISTER	PHASE	DESCRIPTION	W/R	TYPE
				of the i-th harmonic in comparison with the fundamental [%]		
41195	1194	IRMS HARMONIC 5 [%] MSW	L3	Measurement of the Phase - Neutral current of the i-th harmonic in comparison with the fundamental [%]	RO	FLOAT32
41196	1195	IRMS HARMONIC 5 [%] LSW			RO	
41197	1196	IRMS HARMONIC 6 [%] MSW	L1	Measurement of the Phase - Neutral current of the i-th harmonic in comparison with the fundamental [%]	RO	FLOAT32
41198	1197	IRMS HARMONIC 6 [%] LSW			RO	
41199	1198	IRMS HARMONIC 6 [%] MSW	L2	Measurement of the Phase - Neutral current of the i-th harmonic in comparison with the fundamental [%]	RO	FLOAT32
41200	1199	IRMS HARMONIC 6 [%] LSW			RO	
41201	1200	IRMS HARMONIC 6 [%] MSW	L3	Measurement of the Phase - Neutral current of the i-th harmonic in comparison with the fundamental [%]	RO	FLOAT32
41202	1201	IRMS HARMONIC 6 [%] LSW			RO	
41203	1202	IRMS HARMONIC 7 [%] MSW	L1	Measurement of the Phase - Neutral current of the i-th harmonic in comparison with the fundamental [%]	RO	FLOAT32
41204	1203	IRMS HARMONIC 7 [%] LSW			RO	
41205	1204	IRMS HARMONIC 7 [%] MSW	L2	Measurement of the Phase - Neutral current of the i-th harmonic in comparison with the fundamental [%]	RO	FLOAT32
41206	1205	IRMS HARMONIC 7 [%] LSW			RO	
41207	1206	IRMS HARMONIC 7 [%] MSW	L3	Measurement of the Phase - Neutral current of the i-th harmonic in comparison with the fundamental [%]	RO	FLOAT32
41208	1207	IRMS HARMONIC 7 [%] LSW			RO	
41209	1208	IRMS HARMONIC 8 [%] MSW	L1	Measurement of the Phase - Neutral current of the i-th harmonic in comparison with the fundamental [%]	RO	FLOAT32
41210	1209	IRMS HARMONIC 8 [%] LSW			RO	
41211	1210	IRMS HARMONIC 8 [%] MSW	L2		RO	FLOAT32

ADDRESS (4x)	ADDRESS OFFSET	REGISTER	PHASE	DESCRIPTION	W/R	TYPE
41212	1211	IRMS HARMONIC 8 [%] LSW		Measurement of the Phase - Neutral current of the i-th harmonic in comparison with the fundamental [%]	RO	
41213	1212	IRMS HARMONIC 8 [%] MSW	L3	Measurement of the Phase - Neutral current of the i-th harmonic in comparison with the fundamental [%]	RO	FLOAT32
41214	1213	IRMS HARMONIC 8 [%] LSW			RO	
41215	1214	IRMS HARMONIC 9 [%] MSW	L1	Measurement of the Phase - Neutral current of the i-th harmonic in comparison with the fundamental [%]	RO	FLOAT32
41216	1215	IRMS HARMONIC 9 [%] LSW			RO	
41217	1216	IRMS HARMONIC 9 [%] MSW	L2	Measurement of the Phase - Neutral current of the i-th harmonic in comparison with the fundamental [%]	RO	FLOAT32
41218	1217	IRMS HARMONIC 9 [%] LSW			RO	
41219	1218	IRMS HARMONIC 9 [%] MSW	L3	Measurement of the Phase - Neutral current of the i-th harmonic in comparison with the fundamental [%]	RO	FLOAT32
41220	1219	IRMS HARMONIC 9 [%] LSW			RO	
41221	1220	IRMS HARMONIC 10 [%] MSW	L1	Measurement of the Phase - Neutral current of the i-th harmonic in comparison with the fundamental [%]	RO	FLOAT32
41222	1221	IRMS HARMONIC 10 [%] LSW			RO	
41223	1222	IRMS HARMONIC 10 [%] MSW	L2	Measurement of the Phase - Neutral current of the i-th harmonic in comparison with the fundamental [%]	RO	FLOAT32
41224	1223	IRMS HARMONIC 10 [%] LSW			RO	
41225	1224	IRMS HARMONIC 10 [%] MSW	L3	Measurement of the Phase - Neutral current of the i-th harmonic in comparison with the fundamental [%]	RO	FLOAT32
41226	1225	IRMS HARMONIC 10 [%] LSW			RO	
41227	1226	IRMS HARMONIC 11 [%] MSW	L1	Measurement of the Phase - Neutral current of the i-th harmonic in	RO	FLOAT32
41228	1227	IRMS HARMONIC 11 [%] LSW			RO	

ADDRESS (4x)	ADDRESS OFFSET	REGISTER	PHASE	DESCRIPTION	W/R	TYPE
				comparison with the fundamental [%]		
41229	1228	IRMS HARMONIC 11 [%] MSW	L2	Measurement of the Phase - Neutral current of the i-th harmonic in comparison with the fundamental [%]	RO	FLOAT32
41230	1229	IRMS HARMONIC 11 [%] LSW			RO	
41231	1230	IRMS HARMONIC 11 [%] MSW	L3	Measurement of the Phase - Neutral current of the i-th harmonic in comparison with the fundamental [%]	RO	FLOAT32
41232	1231	IRMS HARMONIC 11 [%] LSW			RO	
41233	1232	IRMS HARMONIC 12 [%] MSW	L1	Measurement of the Phase - Neutral current of the i-th harmonic in comparison with the fundamental [%]	RO	FLOAT32
41234	1233	IRMS HARMONIC 12 [%] LSW			RO	
41235	1234	IRMS HARMONIC 12 [%] MSW	L2	Measurement of the Phase - Neutral current of the i-th harmonic in comparison with the fundamental [%]	RO	FLOAT32
41236	1235	IRMS HARMONIC 12 [%] LSW			RO	
41237	1236	IRMS HARMONIC 12 [%] MSW	L3	Measurement of the Phase - Neutral current of the i-th harmonic in comparison with the fundamental [%]	RO	FLOAT32
41238	1237	IRMS HARMONIC 12 [%] LSW			RO	
41239	1238	IRMS HARMONIC 13 [%] MSW	L1	Measurement of the Phase - Neutral current of the i-th harmonic in comparison with the fundamental [%]	RO	FLOAT32
41240	1239	IRMS HARMONIC 13 [%] LSW			RO	
41241	1240	IRMS HARMONIC 13 [%] MSW	L2	Measurement of the Phase - Neutral current of the i-th harmonic in comparison with the fundamental [%]	RO	FLOAT32
41242	1241	IRMS HARMONIC 13 [%] LSW			RO	
41243	1242	IRMS HARMONIC 13 [%] MSW	L3	Measurement of the Phase - Neutral current of the i-th harmonic in comparison with the fundamental [%]	RO	FLOAT32
41244	1243	IRMS HARMONIC 13 [%] LSW			RO	
41245	1244	IRMS HARMONIC 14 [%] MSW	L1	Measurement of the Phase - Neutral current	RO	FLOAT32
41246	1245	IRMS HARMONIC 14 [%] LSW			RO	

ADDRESS (4x)	ADDRESS OFFSET	REGISTER	PHASE	DESCRIPTION	W/R	TYPE
				of the i-th harmonic in comparison with the fundamental [%]		
41247	1246	IRMS HARMONIC 14 [%] MSW	L2	Measurement of the Phase - Neutral current of the i-th harmonic in comparison with the fundamental [%]	RO	FLOAT32
41248	1247	IRMS HARMONIC 14 [%] LSW			RO	
41249	1248	IRMS HARMONIC 14 [%] MSW	L3	Measurement of the Phase - Neutral current of the i-th harmonic in comparison with the fundamental [%]	RO	FLOAT32
41250	1249	IRMS HARMONIC 14 [%] LSW			RO	
41251	1250	IRMS HARMONIC 15 [%] MSW	L1	Measurement of the Phase - Neutral current of the i-th harmonic in comparison with the fundamental [%]	RO	FLOAT32
41252	1251	IRMS HARMONIC 15 [%] LSW			RO	
41253	1252	IRMS HARMONIC 15 [%] MSW	L2	Measurement of the Phase - Neutral current of the i-th harmonic in comparison with the fundamental [%]	RO	FLOAT32
41254	1253	IRMS HARMONIC 15 [%] LSW			RO	
41255	1254	IRMS HARMONIC 15 [%] MSW	L3	Measurement of the Phase - Neutral current of the i-th harmonic in comparison with the fundamental [%]	RO	FLOAT32
41256	1255	IRMS HARMONIC 15 [%] LSW			RO	
41257	1256	IRMS HARMONIC 16 [%] MSW	L1	Measurement of the Phase - Neutral current of the i-th harmonic in comparison with the fundamental [%]	RO	FLOAT32
41258	1257	IRMS HARMONIC 16 [%] LSW			RO	
41259	1258	IRMS HARMONIC 16 [%] MSW	L2	Measurement of the Phase - Neutral current of the i-th harmonic in comparison with the fundamental [%]	RO	FLOAT32
41260	1259	IRMS HARMONIC 16 [%] LSW			RO	
41261	1260	IRMS HARMONIC 16 [%] MSW	L3	Measurement of the Phase - Neutral current of the i-th harmonic in comparison with the fundamental [%]	RO	FLOAT32
41262	1261	IRMS HARMONIC 16 [%] LSW			RO	
41263	1262	IRMS HARMONIC 17 [%] MSW	L1		RO	FLOAT32

ADDRESS (4x)	ADDRESS OFFSET	REGISTER	PHASE	DESCRIPTION	W/R	TYPE
41264	1263	IRMS HARMONIC 17 [%] LSW		Measurement of the Phase - Neutral current of the i-th harmonic in comparison with the fundamental [%]	RO	
41265	1264	IRMS HARMONIC 17 [%] MSW	L2	Measurement of the Phase - Neutral current of the i-th harmonic in comparison with the fundamental [%]	RO	FLOAT32
41266	1265	IRMS HARMONIC 17 [%] LSW			RO	
41267	1266	IRMS HARMONIC 17 [%] MSW	L3	Measurement of the Phase - Neutral current of the i-th harmonic in comparison with the fundamental [%]	RO	FLOAT32
41268	1267	IRMS HARMONIC 17 [%] LSW			RO	
41269	1268	IRMS HARMONIC 18 [%] MSW	L1	Measurement of the Phase - Neutral current of the i-th harmonic in comparison with the fundamental [%]	RO	FLOAT32
41270	1269	IRMS HARMONIC 18 [%] LSW			RO	
41271	1270	IRMS HARMONIC 18 [%] MSW	L2	Measurement of the Phase - Neutral current of the i-th harmonic in comparison with the fundamental [%]	RO	FLOAT32
41272	1271	IRMS HARMONIC 18 [%] LSW			RO	
41273	1272	IRMS HARMONIC 18 [%] MSW	L3	Measurement of the Phase - Neutral current of the i-th harmonic in comparison with the fundamental [%]	RO	FLOAT32
41274	1273	IRMS HARMONIC 18 [%] LSW			RO	
41275	1274	IRMS HARMONIC 19 [%] MSW	L1	Measurement of the Phase - Neutral current of the i-th harmonic in comparison with the fundamental [%]	RO	FLOAT32
41276	1275	IRMS HARMONIC 19 [%] LSW			RO	
41277	1276	IRMS HARMONIC 19 [%] MSW	L2	Measurement of the Phase - Neutral current of the i-th harmonic in comparison with the fundamental [%]	RO	FLOAT32
41278	1277	IRMS HARMONIC 19 [%] LSW			RO	
41279	1278	IRMS HARMONIC 19 [%] MSW	L3	Measurement of the Phase - Neutral current of the i-th harmonic in	RO	FLOAT32
41280	1279	IRMS HARMONIC 19 [%] LSW			RO	

ADDRESS (4x)	ADDRESS OFFSET	REGISTER	PHASE	DESCRIPTION	W/R	TYPE
				comparison with the fundamental [%]		
41281	1280	IRMS HARMONIC 20 [%] MSW	L1	Measurement of the Phase - Neutral current of the i-th harmonic in comparison with the fundamental [%]	RO	FLOAT32
41282	1281	IRMS HARMONIC 20 [%] LSW			RO	
41283	1282	IRMS HARMONIC 20 [%] MSW	L2	Measurement of the Phase - Neutral current of the i-th harmonic in comparison with the fundamental [%]	RO	FLOAT32
41284	1283	IRMS HARMONIC 20 [%] LSW			RO	
41285	1284	IRMS HARMONIC 20 [%] MSW	L3	Measurement of the Phase - Neutral current of the i-th harmonic in comparison with the fundamental [%]	RO	FLOAT32
41286	1285	IRMS HARMONIC 20 [%] LSW			RO	
41287	1286	IRMS HARMONIC 21 [%] MSW	L1	Measurement of the Phase - Neutral current of the i-th harmonic in comparison with the fundamental [%]	RO	FLOAT32
41288	1287	IRMS HARMONIC 21 [%] LSW			RO	
41289	1288	IRMS HARMONIC 21 [%] MSW	L2	Measurement of the Phase - Neutral current of the i-th harmonic in comparison with the fundamental [%]	RO	FLOAT32
41290	1289	IRMS HARMONIC 21 [%] LSW			RO	
41291	1290	IRMS HARMONIC 21 [%] MSW	L3	Measurement of the Phase - Neutral current of the i-th harmonic in comparison with the fundamental [%]	RO	FLOAT32
41292	1291	IRMS HARMONIC 21 [%] LSW			RO	
41293	1292	IRMS HARMONIC 22 [%] MSW	L1	Measurement of the Phase - Neutral current of the i-th harmonic in comparison with the fundamental [%]	RO	FLOAT32
41294	1293	IRMS HARMONIC 22 [%] LSW			RO	
41295	1294	IRMS HARMONIC 22 [%] MSW	L2	Measurement of the Phase - Neutral current of the i-th harmonic in comparison with the fundamental [%]	RO	FLOAT32
41296	1295	IRMS HARMONIC 22 [%] LSW			RO	
41297	1296	IRMS HARMONIC 22 [%] MSW	L3	Measurement of the Phase - Neutral current	RO	FLOAT32
41298	1297	IRMS HARMONIC 22 [%] LSW			RO	

ADDRESS (4x)	ADDRESS OFFSET	REGISTER	PHASE	DESCRIPTION	W/R	TYPE
				of the i-th harmonic in comparison with the fundamental [%]		
41299	1298	IRMS HARMONIC 23 [%] MSW	L1	Measurement of the Phase - Neutral current of the i-th harmonic in comparison with the fundamental [%]	RO	FLOAT32
41300	1299	IRMS HARMONIC 23 [%] LSW			RO	
41301	1300	IRMS HARMONIC 23 [%] MSW	L2	Measurement of the Phase - Neutral current of the i-th harmonic in comparison with the fundamental [%]	RO	FLOAT32
41302	1301	IRMS HARMONIC 23 [%] LSW			RO	
41303	1302	IRMS HARMONIC 23 [%] MSW	L3	Measurement of the Phase - Neutral current of the i-th harmonic in comparison with the fundamental [%]	RO	FLOAT32
41304	1303	IRMS HARMONIC 23 [%] LSW			RO	
41305	1304	IRMS HARMONIC 24 [%] MSW	L1	Measurement of the Phase - Neutral current of the i-th harmonic in comparison with the fundamental [%]	RO	FLOAT32
41306	1305	IRMS HARMONIC 24 [%] LSW			RO	
41307	1306	IRMS HARMONIC 24 [%] MSW	L2	Measurement of the Phase - Neutral current of the i-th harmonic in comparison with the fundamental [%]	RO	FLOAT32
41308	1307	IRMS HARMONIC 24 [%] LSW			RO	
41309	1308	IRMS HARMONIC 24 [%] MSW	L3	Measurement of the Phase - Neutral current of the i-th harmonic in comparison with the fundamental [%]	RO	FLOAT32
41310	1309	IRMS HARMONIC 24 [%] LSW			RO	
41311	1310	IRMS HARMONIC 25 [%] MSW	L1	Measurement of the Phase - Neutral current of the i-th harmonic in comparison with the fundamental [%]	RO	FLOAT32
41312	1311	IRMS HARMONIC 25 [%] LSW			RO	
41313	1312	IRMS HARMONIC 25 [%] MSW	L2	Measurement of the Phase - Neutral current of the i-th harmonic in comparison with the fundamental [%]	RO	FLOAT32
41314	1313	IRMS HARMONIC 25 [%] LSW			RO	
41315	1314	IRMS HARMONIC 25 [%] MSW	L3		RO	FLOAT32

ADDRESS (4x)	ADDRESS OFFSET	REGISTER	PHASE	DESCRIPTION	W/R	TYPE
41316	1315	IRMS HARMONIC 25 [%] LSW		Measurement of the Phase - Neutral current of the i-th harmonic in comparison with the fundamental [%]	RO	
41317	1316	IRMS HARMONIC 26 [%] MSW	L1	Measurement of the Phase - Neutral current of the i-th harmonic in comparison with the fundamental [%]	RO	FLOAT32
41318	1317	IRMS HARMONIC 26 [%] LSW			RO	
41319	1318	IRMS HARMONIC 26 [%] MSW	L2	Measurement of the Phase - Neutral current of the i-th harmonic in comparison with the fundamental [%]	RO	FLOAT32
41320	1319	IRMS HARMONIC 26 [%] LSW			RO	
41321	1320	IRMS HARMONIC 26 [%] MSW	L3	Measurement of the Phase - Neutral current of the i-th harmonic in comparison with the fundamental [%]	RO	FLOAT32
41322	1321	IRMS HARMONIC 26 [%] LSW			RO	
41323	1322	IRMS HARMONIC 27 [%] MSW	L1	Measurement of the Phase - Neutral current of the i-th harmonic in comparison with the fundamental [%]	RO	FLOAT32
41324	1323	IRMS HARMONIC 27 [%] LSW			RO	
41325	1324	IRMS HARMONIC 27 [%] MSW	L2	Measurement of the Phase - Neutral current of the i-th harmonic in comparison with the fundamental [%]	RO	FLOAT32
41326	1325	IRMS HARMONIC 27 [%] LSW			RO	
41327	1326	IRMS HARMONIC 27 [%] MSW	L3	Measurement of the Phase - Neutral current of the i-th harmonic in comparison with the fundamental [%]	RO	FLOAT32
41328	1327	IRMS HARMONIC 27 [%] LSW			RO	
41329	1328	IRMS HARMONIC 28 [%] MSW	L1	Measurement of the Phase - Neutral current of the i-th harmonic in comparison with the fundamental [%]	RO	FLOAT32
41330	1329	IRMS HARMONIC 28 [%] LSW			RO	
41331	1330	IRMS HARMONIC 28 [%] MSW	L2	Measurement of the Phase - Neutral current of the i-th harmonic in	RO	FLOAT32
41332	1331	IRMS HARMONIC 28 [%] LSW			RO	

ADDRESS (4x)	ADDRESS OFFSET	REGISTER	PHASE	DESCRIPTION	W/R	TYPE
				comparison with the fundamental [%]		
41333	1332	IRMS HARMONIC 28 [%] MSW	L3	Measurement of the Phase - Neutral current of the i-th harmonic in comparison with the fundamental [%]	RO	FLOAT32
41334	1333	IRMS HARMONIC 28 [%] LSW			RO	
41335	1334	IRMS HARMONIC 29 [%] MSW	L1	Measurement of the Phase - Neutral current of the i-th harmonic in comparison with the fundamental [%]	RO	FLOAT32
41336	1335	IRMS HARMONIC 29 [%] LSW			RO	
41337	1336	IRMS HARMONIC 29 [%] MSW	L2	Measurement of the Phase - Neutral current of the i-th harmonic in comparison with the fundamental [%]	RO	FLOAT32
41338	1337	IRMS HARMONIC 29 [%] LSW			RO	
41339	1338	IRMS HARMONIC 29 [%] MSW	L3	Measurement of the Phase - Neutral current of the i-th harmonic in comparison with the fundamental [%]	RO	FLOAT32
41340	1339	IRMS HARMONIC 29 [%] LSW			RO	
41341	1340	IRMS HARMONIC 30 [%] MSW	L1	Measurement of the Phase - Neutral current of the i-th harmonic in comparison with the fundamental [%]	RO	FLOAT32
41342	1341	IRMS HARMONIC 30 [%] LSW			RO	
41343	1342	IRMS HARMONIC 30 [%] MSW	L2	Measurement of the Phase - Neutral current of the i-th harmonic in comparison with the fundamental [%]	RO	FLOAT32
41344	1343	IRMS HARMONIC 30 [%] LSW			RO	
41345	1344	IRMS HARMONIC 30 [%] MSW	L3	Measurement of the Phase - Neutral current of the i-th harmonic in comparison with the fundamental [%]	RO	FLOAT32
41346	1345	IRMS HARMONIC 30 [%] LSW			RO	
41347	1346	IRMS HARMONIC 31 [%] MSW	L1	Measurement of the Phase - Neutral current of the i-th harmonic in comparison with the fundamental [%]	RO	FLOAT32
41348	1347	IRMS HARMONIC 31 [%] LSW			RO	
41349	1348	IRMS HARMONIC 31 [%] MSW	L2	Measurement of the Phase - Neutral current	RO	FLOAT32
41350	1349	IRMS HARMONIC 31 [%] LSW			RO	

ADDRESS (4x)	ADDRESS OFFSET	REGISTER	PHASE	DESCRIPTION	W/R	TYPE
				of the i-th harmonic in comparison with the fundamental [%]		
41351	1350	IRMS HARMONIC 31 [%] MSW	L3	Measurement of the Phase - Neutral current of the i-th harmonic in comparison with the fundamental [%]	RO	FLOAT32
41352	1351	IRMS HARMONIC 31 [%] LSW			RO	
41353	1352	IRMS HARMONIC 32 [%] MSW	L1	Measurement of the Phase - Neutral current of the i-th harmonic in comparison with the fundamental [%]	RO	FLOAT32
41354	1353	IRMS HARMONIC 32 [%] LSW			RO	
41355	1354	IRMS HARMONIC 32 [%] MSW	L2	Measurement of the Phase - Neutral current of the i-th harmonic in comparison with the fundamental [%]	RO	FLOAT32
41356	1355	IRMS HARMONIC 32 [%] LSW			RO	
41357	1356	IRMS HARMONIC 32 [%] MSW	L3	Measurement of the Phase - Neutral current of the i-th harmonic in comparison with the fundamental [%]	RO	FLOAT32
41358	1357	IRMS HARMONIC 32 [%] LSW			RO	
41359	1358	IRMS HARMONIC 33 [%] MSW	L1	Measurement of the Phase - Neutral current of the i-th harmonic in comparison with the fundamental [%]	RO	FLOAT32
41360	1359	IRMS HARMONIC 33 [%] LSW			RO	
41361	1360	IRMS HARMONIC 33 [%] MSW	L2	Measurement of the Phase - Neutral current of the i-th harmonic in comparison with the fundamental [%]	RO	FLOAT32
41362	1361	IRMS HARMONIC 33 [%] LSW			RO	
41363	1362	IRMS HARMONIC 33 [%] MSW	L3	Measurement of the Phase - Neutral current of the i-th harmonic in comparison with the fundamental [%]	RO	FLOAT32
41364	1363	IRMS HARMONIC 33 [%] LSW			RO	
41365	1364	IRMS HARMONIC 34 [%] MSW	L1	Measurement of the Phase - Neutral current of the i-th harmonic in comparison with the fundamental [%]	RO	FLOAT32
41366	1365	IRMS HARMONIC 34 [%] LSW			RO	
41367	1366	IRMS HARMONIC 34 [%] MSW	L2		RO	FLOAT32

ADDRESS (4x)	ADDRESS OFFSET	REGISTER	PHASE	DESCRIPTION	W/R	TYPE
41368	1367	IRMS HARMONIC 34 [%] LSW		Measurement of the Phase - Neutral current of the i-th harmonic in comparison with the fundamental [%]	RO	
41369	1368	IRMS HARMONIC 34 [%] MSW	L3	Measurement of the Phase - Neutral current of the i-th harmonic in comparison with the fundamental [%]	RO	FLOAT32
41370	1369	IRMS HARMONIC 34 [%] LSW			RO	
41371	1370	IRMS HARMONIC 35 [%] MSW	L1	Measurement of the Phase - Neutral current of the i-th harmonic in comparison with the fundamental [%]	RO	FLOAT32
41372	1371	IRMS HARMONIC 35 [%] LSW			RO	
41373	1372	IRMS HARMONIC 35 [%] MSW	L2	Measurement of the Phase - Neutral current of the i-th harmonic in comparison with the fundamental [%]	RO	FLOAT32
41374	1373	IRMS HARMONIC 35 [%] LSW			RO	
41375	1374	IRMS HARMONIC 35 [%] MSW	L3	Measurement of the Phase - Neutral current of the i-th harmonic in comparison with the fundamental [%]	RO	FLOAT32
41376	1375	IRMS HARMONIC 35 [%] LSW			RO	
41377	1376	IRMS HARMONIC 36 [%] MSW	L1	Measurement of the Phase - Neutral current of the i-th harmonic in comparison with the fundamental [%]	RO	FLOAT32
41378	1377	IRMS HARMONIC 36 [%] LSW			RO	
41379	1378	IRMS HARMONIC 36 [%] MSW	L2	Measurement of the Phase - Neutral current of the i-th harmonic in comparison with the fundamental [%]	RO	FLOAT32
41380	1379	IRMS HARMONIC 36 [%] LSW			RO	
41381	1380	IRMS HARMONIC 36 [%] MSW	L3	Measurement of the Phase - Neutral current of the i-th harmonic in comparison with the fundamental [%]	RO	FLOAT32
41382	1381	IRMS HARMONIC 36 [%] LSW			RO	
41383	1382	IRMS HARMONIC 37 [%] MSW	L1	Measurement of the Phase - Neutral current of the i-th harmonic in	RO	FLOAT32
41384	1383	IRMS HARMONIC 37 [%] LSW			RO	

ADDRESS (4x)	ADDRESS OFFSET	REGISTER	PHASE	DESCRIPTION	W/R	TYPE
				comparison with the fundamental [%]		
41385	1384	IRMS HARMONIC 37 [%] MSW	L2	Measurement of the Phase - Neutral current of the i-th harmonic in comparison with the fundamental [%]	RO	FLOAT32
41386	1385	IRMS HARMONIC 37 [%] LSW			RO	
41387	1386	IRMS HARMONIC 37 [%] MSW	L3	Measurement of the Phase - Neutral current of the i-th harmonic in comparison with the fundamental [%]	RO	FLOAT32
41388	1387	IRMS HARMONIC 37 [%] LSW			RO	
41389	1388	IRMS HARMONIC 38 [%] MSW	L1	Measurement of the Phase - Neutral current of the i-th harmonic in comparison with the fundamental [%]	RO	FLOAT32
41390	1389	IRMS HARMONIC 38 [%] LSW			RO	
41391	1390	IRMS HARMONIC 38 [%] MSW	L2	Measurement of the Phase - Neutral current of the i-th harmonic in comparison with the fundamental [%]	RO	FLOAT32
41392	1391	IRMS HARMONIC 38 [%] LSW			RO	
41393	1392	IRMS HARMONIC 38 [%] MSW	L3	Measurement of the Phase - Neutral current of the i-th harmonic in comparison with the fundamental [%]	RO	FLOAT32
41394	1393	IRMS HARMONIC 38 [%] LSW			RO	
41395	1394	IRMS HARMONIC 39 [%] MSW	L1	Measurement of the Phase - Neutral current of the i-th harmonic in comparison with the fundamental [%]	RO	FLOAT32
41396	1395	IRMS HARMONIC 39 [%] LSW			RO	
41397	1396	IRMS HARMONIC 39 [%] MSW	L2	Measurement of the Phase - Neutral current of the i-th harmonic in comparison with the fundamental [%]	RO	FLOAT32
41398	1397	IRMS HARMONIC 39 [%] LSW			RO	
41399	1398	IRMS HARMONIC 39 [%] MSW	L3	Measurement of the Phase - Neutral current of the i-th harmonic in comparison with the fundamental [%]	RO	FLOAT32
41400	1399	IRMS HARMONIC 39 [%] LSW			RO	
41401	1400	IRMS HARMONIC 40 [%] MSW	L1	Measurement of the Phase - Neutral current	RO	FLOAT32
41402	1401	IRMS HARMONIC 40 [%] LSW			RO	

ADDRESS (4x)	ADDRESS OFFSET	REGISTER	PHASE	DESCRIPTION	W/R	TYPE
				of the i-th harmonic in comparison with the fundamental [%]		
41403	1402	IRMS HARMONIC 40 [%] MSW	L2	Measurement of the Phase - Neutral current of the i-th harmonic in comparison with the fundamental [%]	RO	FLOAT32
41404	1403	IRMS HARMONIC 40 [%] LSW			RO	
41405	1404	IRMS HARMONIC 40 [%] MSW	L3	Measurement of the Phase - Neutral current of the i-th harmonic in comparison with the fundamental [%]	RO	FLOAT32
41406	1405	IRMS HARMONIC 40 [%] LSW			RO	
41407	1406	IRMS HARMONIC 41 [%] MSW	L1	Measurement of the Phase - Neutral current of the i-th harmonic in comparison with the fundamental [%]	RO	FLOAT32
41408	1407	IRMS HARMONIC 41 [%] LSW			RO	
41409	1408	IRMS HARMONIC 41 [%] MSW	L2	Measurement of the Phase - Neutral current of the i-th harmonic in comparison with the fundamental [%]	RO	FLOAT32
41410	1409	IRMS HARMONIC 41 [%] LSW			RO	
41411	1410	IRMS HARMONIC 41 [%] MSW	L3	Measurement of the Phase - Neutral current of the i-th harmonic in comparison with the fundamental [%]	RO	FLOAT32
41412	1411	IRMS HARMONIC 41 [%] LSW			RO	
41413	1412	IRMS HARMONIC 42 [%] MSW	L1	Measurement of the Phase - Neutral current of the i-th harmonic in comparison with the fundamental [%]	RO	FLOAT32
41414	1413	IRMS HARMONIC 42 [%] LSW			RO	
41415	1414	IRMS HARMONIC 42 [%] MSW	L2	Measurement of the Phase - Neutral current of the i-th harmonic in comparison with the fundamental [%]	RO	FLOAT32
41416	1415	IRMS HARMONIC 42 [%] LSW			RO	
41417	1416	IRMS HARMONIC 42 [%] MSW	L3	Measurement of the Phase - Neutral current of the i-th harmonic in comparison with the fundamental [%]	RO	FLOAT32
41418	1417	IRMS HARMONIC 42 [%] LSW			RO	
41419	1418	IRMS HARMONIC 43 [%] MSW	L1		RO	FLOAT32

ADDRESS (4x)	ADDRESS OFFSET	REGISTER	PHASE	DESCRIPTION	W/R	TYPE
41420	1419	IRMS HARMONIC 43 [%] LSW		Measurement of the Phase - Neutral current of the i-th harmonic in comparison with the fundamental [%]	RO	
41421	1420	IRMS HARMONIC 43 [%] MSW	L2	Measurement of the Phase - Neutral current of the i-th harmonic in comparison with the fundamental [%]	RO	FLOAT32
41422	1421	IRMS HARMONIC 43 [%] LSW			RO	
41423	1422	IRMS HARMONIC 43 [%] MSW	L3	Measurement of the Phase - Neutral current of the i-th harmonic in comparison with the fundamental [%]	RO	FLOAT32
41424	1423	IRMS HARMONIC 43 [%] LSW			RO	
41425	1424	IRMS HARMONIC 44 [%] MSW	L1	Measurement of the Phase - Neutral current of the i-th harmonic in comparison with the fundamental [%]	RO	FLOAT32
41426	1425	IRMS HARMONIC 44 [%] LSW			RO	
41427	1426	IRMS HARMONIC 44 [%] MSW	L2	Measurement of the Phase - Neutral current of the i-th harmonic in comparison with the fundamental [%]	RO	FLOAT32
41428	1427	IRMS HARMONIC 44 [%] LSW			RO	
41429	1428	IRMS HARMONIC 44 [%] MSW	L3	Measurement of the Phase - Neutral current of the i-th harmonic in comparison with the fundamental [%]	RO	FLOAT32
41430	1429	IRMS HARMONIC 44 [%] LSW			RO	
41431	1430	IRMS HARMONIC 45 [%] MSW	L1	Measurement of the Phase - Neutral current of the i-th harmonic in comparison with the fundamental [%]	RO	FLOAT32
41432	1431	IRMS HARMONIC 45 [%] LSW			RO	
41433	1432	IRMS HARMONIC 45 [%] MSW	L2	Measurement of the Phase - Neutral current of the i-th harmonic in comparison with the fundamental [%]	RO	FLOAT32
41434	1433	IRMS HARMONIC 45 [%] LSW			RO	
41435	1434	IRMS HARMONIC 45 [%] MSW	L3	Measurement of the Phase - Neutral current of the i-th harmonic in	RO	FLOAT32
41436	1435	IRMS HARMONIC 45 [%] LSW			RO	

ADDRESS (4x)	ADDRESS OFFSET	REGISTER	PHASE	DESCRIPTION	W/R	TYPE
				comparison with the fundamental [%]		
41437	1436	IRMS HARMONIC 46 [%] MSW	L1	Measurement of the Phase - Neutral current of the i-th harmonic in comparison with the fundamental [%]	RO	FLOAT32
41438	1437	IRMS HARMONIC 46 [%] LSW			RO	
41439	1438	IRMS HARMONIC 46 [%] MSW	L2	Measurement of the Phase - Neutral current of the i-th harmonic in comparison with the fundamental [%]	RO	FLOAT32
41440	1439	IRMS HARMONIC 46 [%] LSW			RO	
41441	1440	IRMS HARMONIC 46 [%] MSW	L3	Measurement of the Phase - Neutral current of the i-th harmonic in comparison with the fundamental [%]	RO	FLOAT32
41442	1441	IRMS HARMONIC 46 [%] LSW			RO	
41443	1442	IRMS HARMONIC 47 [%] MSW	L1	Measurement of the Phase - Neutral current of the i-th harmonic in comparison with the fundamental [%]	RO	FLOAT32
41444	1443	IRMS HARMONIC 47 [%] LSW			RO	
41445	1444	IRMS HARMONIC 47 [%] MSW	L2	Measurement of the Phase - Neutral current of the i-th harmonic in comparison with the fundamental [%]	RO	FLOAT32
41446	1445	IRMS HARMONIC 47 [%] LSW			RO	
41447	1446	IRMS HARMONIC 47 [%] MSW	L3	Measurement of the Phase - Neutral current of the i-th harmonic in comparison with the fundamental [%]	RO	FLOAT32
41448	1447	IRMS HARMONIC 47 [%] LSW			RO	
41449	1448	IRMS HARMONIC 48 [%] MSW	L1	Measurement of the Phase - Neutral current of the i-th harmonic in comparison with the fundamental [%]	RO	FLOAT32
41450	1449	IRMS HARMONIC 48 [%] LSW			RO	
41451	1450	IRMS HARMONIC 48 [%] MSW	L2	Measurement of the Phase - Neutral current of the i-th harmonic in comparison with the fundamental [%]	RO	FLOAT32
41452	1451	IRMS HARMONIC 48 [%] LSW			RO	
41453	1452	IRMS HARMONIC 48 [%] MSW	L3	Measurement of the Phase - Neutral current	RO	FLOAT32
41454	1453	IRMS HARMONIC 48 [%] LSW			RO	

ADDRESS (4x)	ADDRESS OFFSET	REGISTER	PHASE	DESCRIPTION	W/R	TYPE
				of the i-th harmonic in comparison with the fundamental [%]		
41455	1454	IRMS HARMONIC 49 [%] MSW	L1	Measurement of the Phase - Neutral current of the i-th harmonic in comparison with the fundamental [%]	RO	FLOAT32
41456	1455	IRMS HARMONIC 49 [%] LSW			RO	
41457	1456	IRMS HARMONIC 49 [%] MSW	L2	Measurement of the Phase - Neutral current of the i-th harmonic in comparison with the fundamental [%]	RO	FLOAT32
41458	1457	IRMS HARMONIC 49 [%] LSW			RO	
41459	1458	IRMS HARMONIC 49 [%] MSW	L3	Measurement of the Phase - Neutral current of the i-th harmonic in comparison with the fundamental [%]	RO	FLOAT32
41460	1459	IRMS HARMONIC 49 [%] LSW			RO	
41461	1460	IRMS HARMONIC 50 [%] MSW	L1	Measurement of the Phase - Neutral current of the i-th harmonic in comparison with the fundamental [%]	RO	FLOAT32
41462	1461	IRMS HARMONIC 50 [%] LSW			RO	
41463	1462	IRMS HARMONIC 50 [%] MSW	L2	Measurement of the Phase - Neutral current of the i-th harmonic in comparison with the fundamental [%]	RO	FLOAT32
41464	1463	IRMS HARMONIC 50 [%] LSW			RO	
41465	1464	IRMS HARMONIC 50 [%] MSW	L3	Measurement of the Phase - Neutral current of the i-th harmonic in comparison with the fundamental [%]	RO	FLOAT32
41466	1465	IRMS HARMONIC 50 [%] LSW			RO	
41467	1466	IRMS HARMONIC 51 [%] MSW	L1	Measurement of the Phase - Neutral current of the i-th harmonic in comparison with the fundamental [%]	RO	FLOAT32
41468	1467	IRMS HARMONIC 51 [%] LSW			RO	
41469	1468	IRMS HARMONIC 51 [%] MSW	L2	Measurement of the Phase - Neutral current of the i-th harmonic in comparison with the fundamental [%]	RO	FLOAT32
41470	1469	IRMS HARMONIC 51 [%] LSW			RO	
41471	1470	IRMS HARMONIC 51 [%] MSW	L3		RO	FLOAT32

ADDRESS (4x)	ADDRESS OFFSET	REGISTER	PHASE	DESCRIPTION	W/R	TYPE
41472	1471	IRMS HARMONIC 51 [%] LSW		Measurement of the Phase - Neutral current of the i-th harmonic in comparison with the fundamental [%]	RO	
41473	1472	IRMS HARMONIC 52 [%] MSW	L1	Measurement of the Phase - Neutral current of the i-th harmonic in comparison with the fundamental [%]	RO	FLOAT32
41474	1473	IRMS HARMONIC 52 [%] LSW			RO	
41475	1474	IRMS HARMONIC 52 [%] MSW	L2	Measurement of the Phase - Neutral current of the i-th harmonic in comparison with the fundamental [%]	RO	FLOAT32
41476	1475	IRMS HARMONIC 52 [%] LSW			RO	
41477	1476	IRMS HARMONIC 52 [%] MSW	L3	Measurement of the Phase - Neutral current of the i-th harmonic in comparison with the fundamental [%]	RO	FLOAT32
41478	1477	IRMS HARMONIC 52 [%] LSW			RO	
41479	1478	IRMS HARMONIC 53 [%] MSW	L1	Measurement of the Phase - Neutral current of the i-th harmonic in comparison with the fundamental [%]	RO	FLOAT32
41480	1479	IRMS HARMONIC 53 [%] LSW			RO	
41481	1480	IRMS HARMONIC 53 [%] MSW	L2	Measurement of the Phase - Neutral current of the i-th harmonic in comparison with the fundamental [%]	RO	FLOAT32
41482	1481	IRMS HARMONIC 53 [%] LSW			RO	
41483	1482	IRMS HARMONIC 53 [%] MSW	L3	Measurement of the Phase - Neutral current of the i-th harmonic in comparison with the fundamental [%]	RO	FLOAT32
41484	1483	IRMS HARMONIC 53 [%] LSW			RO	
41485	1484	IRMS HARMONIC 54 [%] MSW	L1	Measurement of the Phase - Neutral current of the i-th harmonic in comparison with the fundamental [%]	RO	FLOAT32
41486	1485	IRMS HARMONIC 54 [%] LSW			RO	
41487	1486	IRMS HARMONIC 54 [%] MSW	L2	Measurement of the Phase - Neutral current of the i-th harmonic in	RO	FLOAT32
41488	1487	IRMS HARMONIC 54 [%] LSW			RO	

ADDRESS (4x)	ADDRESS OFFSET	REGISTER	PHASE	DESCRIPTION	W/R	TYPE
				comparison with the fundamental [%]		
41489	1488	IRMS HARMONIC 54 [%] MSW	L3	Measurement of the Phase - Neutral current of the i-th harmonic in comparison with the fundamental [%]	RO	FLOAT32
41490	1489	IRMS HARMONIC 54 [%] LSW			RO	
41491	1490	IRMS HARMONIC 55 [%] MSW	L1	Measurement of the Phase - Neutral current of the i-th harmonic in comparison with the fundamental [%]	RO	FLOAT32
41492	1491	IRMS HARMONIC 55 [%] LSW			RO	
41493	1492	IRMS HARMONIC 55 [%] MSW	L2	Measurement of the Phase - Neutral current of the i-th harmonic in comparison with the fundamental [%]	RO	FLOAT32
41494	1493	IRMS HARMONIC 55 [%] LSW			RO	
41495	1494	IRMS HARMONIC 55 [%] MSW	L3	Measurement of the Phase - Neutral current of the i-th harmonic in comparison with the fundamental [%]	RO	FLOAT32
41496	1495	IRMS HARMONIC 55 [%] LSW			RO	
41497	1496	VRMS AVG [V] MSW	L1	Average VRMS calculated over the configured average time [V]	RO	FLOAT32
41498	1497	VRMS AVG [V] LSW			RO	
41499	1498	VRMS AVG MIN [V] MSW	L1	Minimum VRMS calculated over the configured average time [V]	RW	FLOAT32
41500	1499	VRMS AVG MIN [V] LSW			RW	
41501	1500	VRMS AVG MAX [V] MSW	L1	Maximum VRMS calculated over the configured average time [V]	RW	FLOAT32
41502	1501	VRMS AVG MAX [V] LSW			RW	
41503	1502	VRMS MIN [V] MSW	L1	Device minimum VRMS [V]	RW	FLOAT32
41504	1503	VRMS MIN [V] LSW			RW	
41505	1504	VRMS MAX [V] MSW	L1	Device maximum VRMS [V]	RW	FLOAT32
41506	1505	VRMS MAX [V] LSW			RW	
41507	1506	VRMS AVG [V] MSW	L2	Average VRMS calculated over the configured average time [V]	RO	FLOAT32
41508	1507	VRMS AVG [V] LSW			RO	
41509	1508	VRMS AVG MIN [V] MSW	L2	Minimum VRMS calculated over the configured average time [V]	RW	FLOAT32
41510	1509	VRMS AVG MIN [V] LSW			RW	

ADDRESS (4x)	ADDRESS OFFSET	REGISTER	PHASE	DESCRIPTION	W/R	TYPE
41511	1510	VRMS AVG MAX [V] MSW	L2	Maximum VRMS calculated over the configured average time [V]	RW	FLOAT32
41512	1511	VRMS AVG MAX [V] LSW			RW	
41513	1512	VRMS MIN [V] MSW	L2	Device minimum VRMS [V]	RW	FLOAT32
41514	1513	VRMS MIN [V] LSW			RW	
41515	1514	VRMS MAX [V] MSW	L2	Device maximum VRMS [V]	RW	FLOAT32
41516	1515	VRMS MAX [V] LSW			RW	
41517	1516	VRMS AVG [V] MSW	L3	Average VRMS calculated over the configured average time [V]	RO	FLOAT32
41518	1517	VRMS AVG [V] LSW			RO	
41519	1518	VRMS AVG MIN [V] MSW	L3	Minimum VRMS calculated over the configured average time [V]	RW	FLOAT32
41520	1519	VRMS AVG MIN [V] LSW			RW	
41521	1520	VRMS AVG MAX [V] MSW	L3	Maximum VRMS calculated over the configured average time [V]	RW	FLOAT32
41522	1521	VRMS AVG MAX [V] LSW			RW	
41523	1522	VRMS MIN [V] MSW	L3	Device minimum VRMS [V]	RW	FLOAT32
41524	1523	VRMS MIN [V] LSW			RW	
41525	1524	VRMS MAX [V] MSW	L3	Device maximum VRMS [V]	RW	FLOAT32
41526	1525	VRMS MAX [V] LSW			RW	
41527	1526	IRMS AVG MSW [A]	L1	Average IRMS calculated over the configured average time [A]	RO	FLOAT32
41528	1527	IRMS AVG LSW [A]			RO	
41529	1528	IRMS AVG MIN MSW [A]	L1	Minimum IRMS calculated over the configured average time [A]	RW	FLOAT32
41530	1529	IRMS AVG MIN LSW [A]			RW	
41531	1530	IRMS AVG MAX MSW [A]	L1	Maximum IRMS calculated over the configured average time [A]	RW	FLOAT32
41532	1531	IRMS AVG MAX LSW [A]			RW	
41533	1532	IRMS MIN MSW [A]	L1	Minimum IRMS since device power up [A]	RW	FLOAT32
41534	1533	IRMS MIN LSW [A]			RW	
41535	1534	IRMS MAX MSW [A]	L1	Device maximum IRMS [A]	RW	FLOAT32
41536	1535	IRMS MAX LSW [A]			RW	
41537	1536	IRMS AVG MSW [A]	L2	Average IRMS calculated over the configured average time [A]	RO	FLOAT32
41538	1537	IRMS AVG LSW [A]			RO	
41539	1538	IRMS AVG MIN MSW [A]	L2	Minimum IRMS calculated over the	RW	FLOAT32
41540	1539	IRMS AVG MIN LSW [A]			RW	

ADDRESS (4x)	ADDRESS OFFSET	REGISTER	PHASE	DESCRIPTION	W/R	TYPE
				configured average time [A]		
41541	1540	IRMS AVG MAX MSW [A]	L2	Maximum IRMS calculated over the configured average time [A]	RW	FLOAT32
41542	1541	IRMS AVG MAX LSW [A]			RW	
41543	1542	IRMS MIN MSW [A]	L2	Device minimum IRMS [A]	RW	FLOAT32
41544	1543	IRMS MIN LSW [A]			RW	
41545	1544	IRMS MAX MSW [A]	L2	Maximum IRMS since device power up [A]	RW	FLOAT32
41546	1545	IRMS MAX LSW [A]			RW	
41547	1546	IRMS AVG MSW [A]	L3	Average IRMS calculated over the configured average time [A]	RO	FLOAT32
41548	1547	IRMS AVG LSW [A]			RO	
41549	1548	IRMS AVG MIN MSW [A]	L3	Minimum IRMS calculated over the configured average time [A]	RW	FLOAT32
41550	1549	IRMS AVG MIN LSW [A]			RW	
41551	1550	IRMS AVG MAX MSW [A]	L3	Maximum IRMS calculated over the configured average time [A]	RW	FLOAT32
41552	1551	IRMS AVG MAX LSW [A]			RW	
41553	1552	IRMS MIN MSW [A]	L3	Device minimum IRMS [A]	RW	FLOAT32
41554	1553	IRMS MIN LSW [A]			RW	
41555	1554	IRMS MAX MSW [A]	L3	Device maximum IRMS [A]	RW	FLOAT32
41556	1555	IRMS MAX LSW [A]			RW	
41557	1556	VRMS AVG [V] MSW	L1-L2	Average VRMS calculated over the configured average time [V]	RO	FLOAT32
41558	1557	VRMS AVG [V] LSW			RO	
41559	1558	VRMS AVG MIN [V] MSW	L1-L2	Minimum VRMS calculated over the configured average time [V]	RW	FLOAT32
41560	1559	VRMS AVG MIN [V] LSW			RW	
41561	1560	VRMS AVG MAX [V] MSW	L1-L2	Maximum VRMS calculated over the configured average time [V]	RW	FLOAT32
41562	1561	VRMS AVG MAX [V] LSW			RW	
41563	1562	VRMS MIN [V] MSW	L1-L2	Minimum VRMS since device power up [V]	RW	FLOAT32
41564	1563	VRMS MIN [V] LSW			RW	
41565	1564	VRMS MAX [V] MSW	L1-L2	Maximum VRMS since device power up [V]	RW	FLOAT32
41566	1565	VRMS MAX [V] LSW			RW	
41567	1566	VRMS AVG [V] MSW	L2-L3	Average VRMS calculated over the configured average time [V]	RO	FLOAT32
41568	1567	VRMS AVG [V] LSW			RO	
41569	1568	VRMS AVG MIN [V] MSW	L2-L3		RW	FLOAT32

ADDRESS (4x)	ADDRESS OFFSET	REGISTER	PHASE	DESCRIPTION	W/R	TYPE
41570	1569	VRMS AVG MIN [V] LSW		Minimum VRMS calculated over the configured average time [V]	RW	
41571	1570	VRMS AVG MAX [V] MSW	L2-L3	Maximum VRMS calculated over the configured average time [V]	RW	FLOAT32
41572	1571	VRMS AVG MAX [V] LSW			RW	
41573	1572	VRMS MIN [V] MSW	L2-L3	Minimum VRMS since device power up [V]	RW	FLOAT32
41574	1573	VRMS MIN [V] LSW			RW	
41575	1574	VRMS MAX [V] MSW	L2-L3	Maximum VRMS since device power up [V]	RW	FLOAT32
41576	1575	VRMS MAX [V] LSW			RW	
41577	1576	VRMS AVG [V] MSW	L3-L1	Average VRMS calculated over the configured average time [V]	RO	FLOAT32
41578	1577	VRMS AVG [V] LSW			RO	
41579	1578	VRMS AVG MIN [V] MSW	L3-L1	Minimum VRMS calculated over the configured average time [V]	RW	FLOAT32
41580	1579	VRMS AVG MIN [V] LSW			RW	
41581	1580	VRMS AVG MAX [V] MSW	L3-L1	Maximum VRMS calculated over the configured average time [V]	RW	FLOAT32
41582	1581	VRMS AVG MAX [V] LSW			RW	
41583	1582	VRMS MIN [V] MSW	L3-L1	Minimum VRMS since device power up [V]	RW	FLOAT32
41584	1583	VRMS MIN [V] LSW			RW	
41585	1584	VRMS MAX [V] MSW	L3-L1	Maximum VRMS since device power up [V]	RW	FLOAT32
41586	1585	VRMS MAX [V] LSW			RW	
41587	1586	P AVG [W] MSW	L1	Average Active Power calculated over the configured average time [W]	RO	FLOAT32
41588	1587	P AVG [W] LSW			RO	
41589	1588	P AVG MIN [W] MSW	L1	Minimum Active Power calculated over the configured average time [W]	RW	FLOAT32
41590	1589	P AVG MIN [W] LSW			RW	
41591	1590	P AVG MAX [W] MSW	L1	Maximum Active Power calculated over the configured average time [W]	RW	FLOAT32
41592	1591	P AVG MAX [W] LSW			RW	
41593	1592	P MIN [W] MSW	L1	Minimum Active Power since device power up [W]	RW	FLOAT32
41594	1593	P MIN [W] LSW			RW	
41595	1594	P MAX [W] MSW	L1	Maximum Active Power since device power up [W]	RW	FLOAT32
41596	1595	P MAX [W] LSW			RW	
41597	1596	P AVG [W] MSW	L2	Average Active Power calculated over the	RO	FLOAT32
41598	1597	P AVG [W] LSW			RO	

ADDRESS (4x)	ADDRESS OFFSET	REGISTER	PHASE	DESCRIPTION	W/R	TYPE
				configured average time [W]		
41599	1598	P AVG MIN [W] MSW	L2	Minimum Active Power calculated over the configured average time [W]	RW	FLOAT32
41600	1599	P AVG MIN [W] LSW			RW	
41601	1600	P AVG MAX [W] MSW	L2	Maximum Active Power calculated over the configured average time [WA]	RW	FLOAT32
41602	1601	P AVG MAX [W] LSW			RW	
41603	1602	P MIN [W] MSW	L2	Minimum Active Power since device power up [W]	RW	FLOAT32
41604	1603	P MIN [W] LSW			RW	
41605	1604	P MAX [W] MSW	L2	Maximum Active Power since device power up [W]	RW	FLOAT32
41606	1605	P MAX [W] LSW			RW	
41607	1606	P AVG [W] MSW	L3	Average Active Power calculated over the configured average time [W]	RO	FLOAT32
41608	1607	P AVG [W] LSW			RO	
41609	1608	P AVG MIN [W] MSW	L3	Minimum Active Power calculated over the configured average time [W]	RW	FLOAT32
41610	1609	P AVG MIN [W] LSW			RW	
41611	1610	P AVG MAX [W] MSW	L3	Maximum Active Power calculated over the configured average time [WA]	RW	FLOAT32
41612	1611	P AVG MAX [W] LSW			RW	
41613	1612	P MIN [W] MSW	L3	Minimum Active Power since device power up [W]	RW	FLOAT32
41614	1613	P MIN [W] LSW			RW	
41615	1614	P MAX [W] MSW	L3	Maximum Active Power since device power up [W]	RW	FLOAT32
41616	1615	P MAX [W] LSW			RW	
41617	1616	Q AVG [VAR] MSW	L1	Average Reactive Power calculated over the configured average time [VAR]	RO	FLOAT32
41618	1617	Q AVG [VAR] LSW			RO	
41619	1618	Q AVG MIN [VAR] MSW	L1	Minimum Reactive Power calculated over the configured average time [VAR]	RW	FLOAT32
41620	1619	Q AVG MIN [VAR] LSW			RW	
41621	1620	Q AVG MAX [VAR] MSW	L1	Maximum Reactive Power calculated over the configured average time [VAR]	RW	FLOAT32
41622	1621	Q AVG MAX [VAR] LSW			RW	
41623	1622	Q MIN [VAR] MSW	L1	Minimum Reactive Power since device power up [VAR]	RW	FLOAT32
41624	1623	Q MIN [VAR] LSW			RW	
41625	1624	Q MAX [VAR] MSW	L1		RW	FLOAT32

ADDRESS (4x)	ADDRESS OFFSET	REGISTER	PHASE	DESCRIPTION	W/R	TYPE
41626	1625	Q MAX [VAR] LSW		Maximum Reactive Power since device power up [VAR]	RW	
41627	1626	Q AVG [VAR] MSW	L2	Average Reactive Power calculated over the configured average time [VAR]	RO	FLOAT32
41628	1627	Q AVG [VAR] LSW			RO	
41629	1628	Q AVG MIN [VAR] MSW	L2	Minimum Reactive Power calculated over the configured average time [VAR]	RW	FLOAT32
41630	1629	Q AVG MIN [VAR] LSW			RW	
41631	1630	Q AVG MAX [VAR] MSW	L2	Maximum Reactive Power calculated over the configured average time [VAR]	RW	FLOAT32
41632	1631	Q AVG MAX [VAR] LSW			RW	
41633	1632	Q MIN [VAR] MSW	L2	Minimum Reactive Power since device power up [VAR]	RW	FLOAT32
41634	1633	Q MIN [VAR] LSW			RW	
41635	1634	Q MAX [VAR] MSW	L2	Maximum Reactive Power since device power up [VAR]	RW	FLOAT32
41636	1635	Q MAX [VAR] LSW			RW	
41637	1636	Q AVG [VAR] MSW	L3	Average Reactive Power calculated over the configured average time [VAR]	RO	FLOAT32
41638	1637	Q AVG [VAR] LSW			RO	
41639	1638	Q AVG MIN [VAR] MSW	L3	Minimum Reactive Power calculated over the configured average time [VAR]	RW	FLOAT32
41640	1639	Q AVG MIN [VAR] LSW			RW	
41641	1640	Q AVG MAX [VAR] MSW	L3	Maximum Reactive Power calculated over the configured average time [VAR]	RW	FLOAT32
41642	1641	Q AVG MAX [VAR] LSW			RW	
41643	1642	Q MIN [VAR] MSW	L3	Minimum Reactive Power since device power up [VAR]	RW	FLOAT32
41644	1643	Q MIN [VAR] LSW			RW	
41645	1644	Q MAX [VAR] MSW	L3	Maximum Reactive Power since device power up [VAR]	RW	FLOAT32
41646	1645	Q MAX [VAR] LSW			RW	
41647	1646	S AVG [VA] MSW	L1	Average Apparent Power calculated over the configured average time [VA]	RO	FLOAT32
41648	1647	S AVG [VA] LSW			RO	
41649	1648	S AVG MIN [VA] MSW	L1	Minimum Apparent Power calculated over the configured average time [VA]	RW	FLOAT32
41650	1649	S AVG MIN [VA] LSW			RW	
41651	1650	S AVG MAX [VA] MSW	L1	Maximum Apparent Power calculated over	RW	FLOAT32
41652	1651	S AVG MAX [VA] LSW			RW	

ADDRESS (4x)	ADDRESS OFFSET	REGISTER	PHASE	DESCRIPTION	W/R	TYPE
				the configured average time [VA]		
41653	1652	S MIN [VA] MSW	L1	Minimum Apparent Power since device power up [VA]	RW	FLOAT32
41654	1653	S MIN [VA] LSW			RW	
41655	1654	S MAX [VA] MSW	L1	Maximum Apparent Power since device power up [VA]	RW	FLOAT32
41656	1655	S MAX [VA] LSW			RW	
41657	1656	S AVG [VA] MSW	L2	Average Apparent Power calculated over the configured average time [VA]	RO	FLOAT32
41658	1657	S AVG [VA] LSW			RO	
41659	1658	S AVG MIN [VA] MSW	L2	Minimum Apparent Power calculated over the configured average time [VA]	RW	FLOAT32
41660	1659	S AVG MIN [VA] LSW			RW	
41661	1660	S AVG MAX [VA] MSW	L2	Maximum Apparent Power calculated over the configured average time [VA]	RW	FLOAT32
41662	1661	S AVG MAX [VA] LSW			RW	
41663	1662	S MIN [VA] MSW	L2	Minimum Apparent Power since device power up [VA]	RW	FLOAT32
41664	1663	S MIN [VA] LSW			RW	
41665	1664	S MAX [VA] MSW	L2	Maximum Apparent Power since device power up [VA]	RW	FLOAT32
41666	1665	S MAX [VA] LSW			RW	
41667	1666	S AVG [VA] MSW	L3	Average Apparent Power calculated over the configured average time [VA]	RO	FLOAT32
41668	1667	S AVG [VA] LSW			RO	
41669	1668	S AVG MIN [VA] MSW	L3	Minimum Apparent Power calculated over the configured average time [VA]	RW	FLOAT32
41670	1669	S AVG MIN [VA] LSW			RW	
41671	1670	S AVG MAX [VA] MSW	L3	Maximum Apparent Power calculated over the configured average time [VA]	RW	FLOAT32
41672	1671	S AVG MAX [VA] LSW			RW	
41673	1672	S MIN [VA] MSW	L3	Minimum Apparent Power since device power up [VA]	RW	FLOAT32
41674	1673	S MIN [VA] LSW			RW	
41675	1674	S MAX [VA] MSW	L3	Maximum Apparent Power since device power up [VA]	RW	FLOAT32
41676	1675	S MAX [VA] LSW			RW	
41677	1676	PF AVG MSW	L1	Average Power Factor calculated over the configured average time	RO	FLOAT32
41678	1677	PF AVG LSW			RO	
41679	1678	PF AVG MIN MSW	L1	Minimum Power Factor calculated over	RW	FLOAT32
41680	1679	PF AVG MIN LSW			RW	

ADDRESS (4x)	ADDRESS OFFSET	REGISTER	PHASE	DESCRIPTION	W/R	TYPE
				the configured average time		
41681	1680	PF AVG MAX MSW	L1	Maximum Power Factor calculated over the configured average time	RW	FLOAT32
41682	1681	PF AVG MAX LSW			RW	
41683	1682	PF MIN MSW	L1	Minimum Power Factor since device power up	RW	FLOAT32
41684	1683	PF MIN LSW			RW	
41685	1684	PF MAX MSW	L1	Maximum Power Factor since device power up	RW	FLOAT32
41686	1685	PF MAX LSW			RW	
41687	1686	PF AVG MSW	L2	Average Power Factor calculated over the configured average time	RO	FLOAT32
41688	1687	PF AVG LSW			RO	
41689	1688	PF AVG MIN MSW	L2	Minimum Power Factor calculated over the configured average time	RW	FLOAT32
41690	1689	PF AVG MIN LSW			RW	
41691	1690	PF AVG MAX MSW	L2	Maximum Power Factor calculated over the configured average time	RW	FLOAT32
41692	1691	PF AVG MAX LSW			RW	
41693	1692	PF MIN MSW	L2	Minimum Power Factor since device power up	RW	FLOAT32
41694	1693	PF MIN LSW			RW	
41695	1694	PF MAX MSW	L2	Maximum Power Factor since device power up	RW	FLOAT32
41696	1695	PF MAX LSW			RW	
41697	1696	PF AVG MSW	L3	Average Power Factor calculated over the configured average time	RO	FLOAT32
41698	1697	PF AVG LSW			RO	
41699	1698	PF AVG MIN MSW	L3	Minimum Power Factor calculated over the configured average time	RW	FLOAT32
41700	1699	PF AVG MIN LSW			RW	
41701	1700	PF AVG MAX MSW	L3	Maximum Power Factor calculated over the configured average time	RW	FLOAT32
41702	1701	PF AVG MAX LSW			RW	
41703	1702	PF MIN MSW	L3	Minimum Power Factor since device power up	RW	FLOAT32
41704	1703	PF MIN LSW			RW	
41705	1704	PF MAX MSW	L3	Maximum Power Factor since device power up	RW	FLOAT32
41706	1705	PF MAX LSW			RW	
41707	1706	P AVG [W] MSW	3PH	Average Active Power calculated over the	RO	FLOAT32
41708	1707	P AVG [W] LSW			RO	

ADDRESS (4x)	ADDRESS OFFSET	REGISTER	PHASE	DESCRIPTION	W/R	TYPE
				configured average time [W]		
41709	1708	P AVG MIN [W] MSW	3PH	Minimum Active Power calculated over the configured average time [W]	RW	FLOAT32
41710	1709	P AVG MIN [W] LSW			RW	
41711	1710	P AVG MAX [W] MSW	3PH	Maximum Active Power calculated over the configured average time [WA]	RW	FLOAT32
41712	1711	P AVG MAX [W] LSW			RW	
41713	1712	P MIN [W] MSW	3PH	Minimum Active Power since device power up [W]	RW	FLOAT32
41714	1713	P MIN [W] LSW			RW	
41715	1714	P MAX [W] MSW	3PH	Maximum Active Power since device power up [W]	RW	FLOAT32
41716	1715	P MAX [W] LSW			RW	
41717	1716	Q AVG [VAR] MSW	3PH	Average Reactive Power calculated over the configured average time [VAR]	RO	FLOAT32
41718	1717	Q AVG [VAR] LSW			RO	
41719	1718	Q AVG MIN [VAR] MSW	3PH	Minimum Reactive Power calculated over the configured average time [VAR]	RW	FLOAT32
41720	1719	Q AVG MIN [VAR] LSW			RW	
41721	1720	Q AVG MAX [VAR] MSW	3PH	Maximum Reactive Power calculated over the configured average time [VAR]	RW	FLOAT32
41722	1721	Q AVG MAX [VAR] LSW			RW	
41723	1722	Q MIN [VAR] MSW	3PH	Minimum Reactive Power since device power up [VAR]	RW	FLOAT32
41724	1723	Q MIN [VAR] LSW			RW	
41725	1724	Q MAX [VAR] MSW	3PH	Maximum Reactive Power since device power up [VAR]	RW	FLOAT32
41726	1725	Q MAX [VAR] LSW			RW	
41727	1726	S AVG [VA] MSW	3PH	Average Apparent Power calculated over the configured average time [VA]	RO	FLOAT32
41728	1727	S AVG [VA] LSW			RO	
41729	1728	S AVG MIN [VA] MSW	3PH	Minimum Apparent Power calculated over the configured average time [VA]	RW	FLOAT32
41730	1729	S AVG MIN [VA] LSW			RW	
41731	1730	S AVG MAX [VA] MSW	3PH	Maximum Apparent Power calculated over the configured average time [VA]	RW	FLOAT32
41732	1731	S AVG MAX [VA] LSW			RW	
41733	1732	S MIN [VA] MSW	3PH	Minimum Apparent Power since device power up [VA]	RW	FLOAT32
41734	1733	S MIN [VA] LSW			RW	
41735	1734	S MAX [VA] MSW	3PH		RW	FLOAT32

ADDRESS (4x)	ADDRESS OFFSET	REGISTER	PHASE	DESCRIPTION	W/R	TYPE
41736	1735	S MAX [VA] LSW		Maximum Apparent Power since device power up [VA]	RW	
41737	1736	PF AVG MSW	3PH	Average Power Factor calculated over the configured average time	RO	FLOAT32
41738	1737	PF AVG LSW			RO	
41739	1738	PF AVG MIN MSW	3PH	Minimum Power Factor calculated over the configured average time	RW	FLOAT32
41740	1739	PF AVG MIN LSW			RW	
41741	1740	PF AVG MAX MSW	3PH	Maximum Power Factor calculated over the configured average time	RW	FLOAT32
41742	1741	PF AVG MAX LSW			RW	
41743	1742	PF MIN MSW	3PH	Minimum Power Factor since device power up	RW	FLOAT32
41744	1743	PF MIN LSW			RW	
41745	1744	PF MAX MSW	3PH	Maximum Power Factor since device power up	RW	FLOAT32
41746	1745	PF MAX LSW			RW	
41747	1746	E ACTIVE ENERGY (+) [Wh] MMSW	L1	Active Energy (Only +) Q1-Q4 [Wh]	RW	UNSIGNED64
41748	1747	E ACTIVE ENERGY (+) [Wh] MSW			RW	
41749	1748	E ACTIVE ENERGY (+) [Wh] LSW			RW	
41750	1749	E ACTIVE ENERGY (+) [Wh] LLSW			RW	
41751	1750	E ACTIVE ENERGY (+) [Wh] MMSW	L2	Active Energy (Only +) Q1-Q4 [Wh]	RW	UNSIGNED64
41752	1751	E ACTIVE ENERGY (+) [Wh] MSW			RW	
41753	1752	E ACTIVE ENERGY (+) [Wh] LSW			RW	
41754	1753	E ACTIVE ENERGY (+) [Wh] LLSW			RW	
41755	1754	E ACTIVE ENERGY (+) [Wh] MMSW	L3	Active Energy (Only +) Q1-Q4 [Wh]	RW	UNSIGNED64
41756	1755	E ACTIVE ENERGY (+) [Wh] MSW			RW	
41757	1756	E ACTIVE ENERGY (+) [Wh] LSW			RW	
41758	1757	E ACTIVE ENERGY (+) [Wh] LLSW			RW	
41759	1758	E ACTIVE ENERGY (-) [Wh] MMSW	L1	Active Energy (Only -) Q2-Q3 [Wh]	RW	UNSIGNED64
41760	1759	E ACTIVE ENERGY (-) [Wh] MSW			RW	
41761	1760	E ACTIVE ENERGY (-) [Wh] LSW			RW	
41762	1761	E ACTIVE ENERGY (-) [Wh] LLSW			RW	
41763	1762	E ACTIVE ENERGY (-) [Wh] MMSW	L2	Active Energy (Only -) Q2-Q3 [Wh]	RW	UNSIGNED64

ADDRESS (4x)	ADDRESS OFFSET	REGISTER	PHASE	DESCRIPTION	W/R	TYPE
41764	1763	E ACTIVE ENERGY (-) [Wh] MSW			RW	
41765	1764	E ACTIVE ENERGY (-) [Wh] LSW			RW	
41766	1765	E ACTIVE ENERGY (-) [Wh] LLSW			RW	
41767	1766	E ACTIVE ENERGY (-) [Wh] MMSW	L3	Active Energy (Only -) Q2-Q3 [Wh]	RW	UNSIGNED64
41768	1767	E ACTIVE ENERGY (-) [Wh] MSW			RW	
41769	1768	E ACTIVE ENERGY (-) [Wh] LSW			RW	
41770	1769	E ACTIVE ENERGY (-) [Wh] LLSW			RW	
41771	1770	E REACTIVE ENERGY (+) [VARh] MMSW	L1	Reactive Energy (Only +) Q1-Q2 [VARh]	RW	UNSIGNED64
41772	1771	E REACTIVE ENERGY (+) [VARh] MSW			RW	
41773	1772	E REACTIVE ENERGY (+) [VARh] LSW			RW	
41774	1773	E REACTIVE ENERGY (+) [VARh] LLSW			RW	
41775	1774	E REACTIVE ENERGY (+) [VARh] MMSW	L2	Reactive Energy (Only +) Q1-Q2 [VARh]	RW	UNSIGNED64
41776	1775	E REACTIVE ENERGY (+) [VARh] MSW			RW	
41777	1776	E REACTIVE ENERGY (+) [VARh] LSW			RW	
41778	1777	E REACTIVE ENERGY (+) [VARh] LLSW			RW	
41779	1778	E REACTIVE ENERGY (+) [VARh] MMSW	L3	Reactive Energy (Only +) Q1-Q2 [VARh]	RW	UNSIGNED64
41780	1779	E REACTIVE ENERGY (+) [VARh] MSW			RW	
41781	1780	E REACTIVE ENERGY (+) [VARh] LSW			RW	
41782	1781	E REACTIVE ENERGY (+) [VARh] LLSW			RW	
41783	1782	E REACTIVE ENERGY (-) [VARh] MMSW	L1	Reactive Energy (Only -) Q3-Q4 [VARh]	RW	UNSIGNED64
41784	1783	E REACTIVE ENERGY (-) [VARh] MSW			RW	
41785	1784	E REACTIVE ENERGY (-) [VARh] LSW			RW	
41786	1785	E REACTIVE ENERGY (-) [VARh] LLSW			RW	
41787	1786	E REACTIVE ENERGY (-) [VARh] MMSW	L2	Reactive Energy (Only -) Q3-Q4 [VARh]	RW	UNSIGNED64
41788	1787	E REACTIVE ENERGY (-) [VARh] MSW			RW	
41789	1788	E REACTIVE ENERGY (-) [VARh] LSW			RW	
41790	1789	E REACTIVE ENERGY (-) [VARh] LLSW			RW	

ADDRESS (4x)	ADDRESS OFFSET	REGISTER	PHASE	DESCRIPTION	W/R	TYPE
41791	1790	E REACTIVE ENERGY (-) [VARh] MMSW	L3	Reactive Energy (Only -) Q3-Q4 [VARh]	RW	UNSIGNED64
41792	1791	E REACTIVE ENERGY (-) [VARh] MSW			RW	
41793	1792	E REACTIVE ENERGY (-) [VARh] LSW			RW	
41794	1793	E REACTIVE ENERGY (-) [VARh] LLSW			RW	
41795	1794	E REACTIVE ENERGY (+)[VARh] MMSW	L1	Reactive Energy (Only +) Q1 [VARh]	RW	UNSIGNED64
41796	1795	E REACTIVE ENERGY (+)[VARh] MSW			RW	
41797	1796	E REACTIVE ENERGY (+)[VARh] LSW			RW	
41798	1797	E REACTIVE ENERGY (+)[VARh] LLSW			RW	
41799	1798	E REACTIVE ENERGY (+)[VARh] MMSW	L2	Reactive Energy (Only +) Q1 [VARh]	RW	UNSIGNED64
41800	1799	E REACTIVE ENERGY (+)[VARh] MSW			RW	
41801	1800	E REACTIVE ENERGY (+)[VARh] LSW			RW	
41802	1801	E REACTIVE ENERGY (+)[VARh] LLSW			RW	
41803	1802	E REACTIVE ENERGY (+)[VARh] MMSW	L3	Reactive Energy (Only +) Q1 [VARh]	RW	UNSIGNED64
41804	1803	E REACTIVE ENERGY (+)[VARh] MSW			RW	
41805	1804	E REACTIVE ENERGY (+)[VARh] LSW			RW	
41806	1805	E REACTIVE ENERGY (+)[VARh] LLSW			RW	
41807	1806	E REACTIVE ENERGY (-) [VARh] MMSW	L1	Reactive Energy (Only -) Q2 [VARh]	RW	UNSIGNED64
41808	1807	E REACTIVE ENERGY (-) [VARh] MSW			RW	
41809	1808	E REACTIVE ENERGY (-) [VARh] LSW			RW	
41810	1809	E REACTIVE ENERGY (-) [VARh] LLSW			RW	
41811	1810	E REACTIVE ENERGY (-) [VARh] MMSW	L2	Reactive Energy (Only -) Q2 [VARh]	RW	UNSIGNED64

ADDRESS (4x)	ADDRESS OFFSET	REGISTER	PHASE	DESCRIPTION	W/R	TYPE
41812	1811	E REACTIVE ENERGY (-) [VARh] MSW			RW	
41813	1812	E REACTIVE ENERGY (-) [VARh] LSW			RW	
41814	1813	E REACTIVE ENERGY (-) [VARh] LLSW			RW	
41815	1814	E REACTIVE ENERGY (-) [VARh] MMSW	L3	Reactive Energy (Only -) Q2 [VARh]	RW	UNSIGNED64
41816	1815	E REACTIVE ENERGY (-) [VARh] MSW			RW	
41817	1816	E REACTIVE ENERGY (-) [VARh] LSW			RW	
41818	1817	E REACTIVE ENERGY (-) [VARh] LLSW			RW	
41819	1818	E REACTIVE ENERGY (-)[VARh] MMSW	L1	Reactive Energy (Only -) Q4 [VARh]	RW	UNSIGNED64
41820	1819	E REACTIVE ENERGY (-) [VARh] MSW			RW	
41821	1820	E REACTIVE ENERGY (-) [VARh] LSW			RW	
41822	1821	E REACTIVE ENERGY (-) [VARh] LLSW			RW	
41823	1822	E REACTIVE ENERGY (-)[VARh] MMSW	L2	Reactive Energy (Only -) Q4 [VARh]	RW	UNSIGNED64
41824	1823	E REACTIVE ENERGY (-) [VARh] MSW			RW	
41825	1824	E REACTIVE ENERGY (-) [VARh] LSW			RW	
41826	1825	E REACTIVE ENERGY (-) [VARh] LLSW			RW	
41827	1826	E REACTIVE ENERGY (-)[VARh] MMSW	L3	Reactive Energy (Only -) Q4 [VARh]	RW	UNSIGNED64
41828	1827	E REACTIVE ENERGY (-) [VARh] MSW			RW	
41829	1828	E REACTIVE ENERGY (-) [VARh] LSW			RW	
41830	1829	E REACTIVE ENERGY (-) [VARh] LLSW			RW	
41831	1830	E REACTIVE ENERGY (-)[VARh] MMSW	L1	Reactive Energy (Only -) Q3 [VARh]	RW	UNSIGNED64

ADDRESS (4x)	ADDRESS OFFSET	REGISTER	PHASE	DESCRIPTION	W/R	TYPE
41832	1831	E REACTIVE ENERGY (-)[VARh] MSW			RW	
41833	1832	E REACTIVE ENERGY (-)[VARh] LSW			RW	
41834	1833	E REACTIVE ENERGY (-)[VARh] LLSW			RW	
41835	1834	E REACTIVE ENERGY (-)[VARh] MMSW	L2	Reactive Energy (Only -) Q3 [VARh]	RW	UNSIGNED64
41836	1835	E REACTIVE ENERGY (-) [VARh] MSW			RW	
41837	1836	E REACTIVE ENERGY (-) [VARh] LSW			RW	
41838	1837	E REACTIVE ENERGY (-) [VARh] LLSW			RW	
41839	1838	E REACTIVE ENERGY (-) [VARh] MMSW	L3	Reactive Energy (Only -) Q3 [VARh]	RW	UNSIGNED64
41840	1839	E REACTIVE ENERGY (-) [VARh] MSW			RW	
41841	1840	E REACTIVE ENERGY (-) [VARh] LSW			RW	
41842	1841	E REACTIVE ENERGY (-) [VARh] LLSW			RW	
41843	1842	E ACTIVE ENERGY [Wh] MMSW	L1	Total Active Energy [Wh]	RW	UNSIGNED64
41844	1843	E ACTIVE ENERGY [Wh] MSW			RW	
41845	1844	E ACTIVE ENERGY [Wh] LSW			RW	
41846	1845	E ACTIVE ENERGY [Wh] LLSW			RW	
41847	1846	E ACTIVE ENERGY [Wh] MMSW	L2	Total Active Energy [Wh]	RW	SIGNED64
41848	1847	E ACTIVE ENERGY [Wh] MSW			RW	
41849	1848	E ACTIVE ENERGY [Wh] LSW			RW	
41850	1849	E ACTIVE ENERGY [Wh] LLSW			RW	
41851	1850	E ACTIVE ENERGY [Wh] MMSW	L3	Total Active Energy [Wh]	RW	SIGNED64
41852	1851	E ACTIVE ENERGY [Wh] MSW			RW	
41853	1852	E ACTIVE ENERGY [Wh] LSW			RW	
41854	1853	E ACTIVE ENERGY [Wh] LLSW			RW	
41855	1854	E REACTIVE ENERGY [VARh] MMSW	L1	Total Reactive Energy [VARh]	RW	SIGNED64
41856	1855	E REACTIVE ENERGY [VARh] MSW			RW	
41857	1856	E REACTIVE ENERGY [VARh] LSW			RW	
41858	1857	E REACTIVE ENERGY [VARh] LLSW			RW	

ADDRESS (4x)	ADDRESS OFFSET	REGISTER	PHASE	DESCRIPTION	W/R	TYPE
41859	1858	E REACTIVE ENERGY [VARh] MMSW	L2	Total Reactive Energy [VARh]	RW	SIGNED64
41860	1859	E REACTIVE ENERGY [VARh] MSW			RW	
41861	1860	E REACTIVE ENERGY [VARh] LSW			RW	
41862	1861	E REACTIVE ENERGY [VARh] LLSW			RW	
41863	1862	E REACTIVE ENERGY [VARh] MMSW	L3	Total Reactive Energy [VARh]	RW	SIGNED64
41864	1863	E REACTIVE ENERGY [VARh] MSW			RW	
41865	1864	E REACTIVE ENERGY [VARh] LSW			RW	
41866	1865	E REACTIVE ENERGY [VARh] LLSW			RW	
41867	1866	E REACTIVE ENERGY [VARh] MMSW	L1	Total Apparent Energy [VAh]	RW	SIGNED64
41868	1867	E REACTIVE ENERGY [VARh] MSW			RW	
41869	1868	E REACTIVE ENERGY [VARh] LSW			RW	
41870	1869	E REACTIVE ENERGY [VARh] LLSW			RW	
41871	1870	E REACTIVE ENERGY [VARh] MMSW	L2	Total Apparent Energy [VAh]	RW	SIGNED64
41872	1871	E REACTIVE ENERGY [VARh] MSW			RW	
41873	1872	E REACTIVE ENERGY [VARh] LSW			RW	
41874	1873	E REACTIVE ENERGY [VARh] LLSW			RW	
41875	1874	E REACTIVE ENERGY [VARh] MMSW	L3	Total Apparent Energy [VAh]	RW	SIGNED64
41876	1875	E REACTIVE ENERGY [VARh] MSW			RW	
41877	1876	E REACTIVE ENERGY [VARh] LSW			RW	
41878	1877	E REACTIVE ENERGY [VARh] LLSW			RW	
41879	1878	E ACTIVE ENERGY (+) [Wh] MMSW	3PH	Active Energy (Only +) Q1-Q4 [Wh]	RW	UNSIGNED64
41880	1879	E ACTIVE ENERGY (+) [Wh] MSW			RW	
41881	1880	E ACTIVE ENERGY (+) [Wh] LSW			RW	
41882	1881	E ACTIVE ENERGY (+) [Wh] LLSW			RW	
41883	1882	E ACTIVE ENERGY (-) [Wh] MMSW	3PH	Active Energy (Only -) Q2-Q3 [Wh]	RW	UNSIGNED64

ADDRESS (4x)	ADDRESS OFFSET	REGISTER	PHASE	DESCRIPTION	W/R	TYPE
41884	1883	E ACTIVE ENERGY (-) [Wh] MSW			RW	
41885	1884	E ACTIVE ENERGY (-) [Wh] LSW			RW	
41886	1885	E ACTIVE ENERGY (-) [Wh] LLSW			RW	
41887	1886	E REACTIVE ENERGY (+) [VARh] MMSW	3PH	Reactive Energy (Only +) Q1-Q2 [Wh]	RW	UNSIGNED64
41888	1887	E REACTIVE ENERGY (+) [VARh] MSW			RW	
41889	1888	E REACTIVE ENERGY (+) [VARh] LSW			RW	
41890	1889	E REACTIVE ENERGY (+) [VARh] LLSW			RW	
41891	1890	E REACTIVE ENERGY (-) [VARh] MMSW	3PH	Reactive Energy (Only -) Q3-Q4 [Wh]	RW	UNSIGNED64
41892	1891	E REACTIVE ENERGY (-) [VARh] MSW			RW	
41893	1892	E REACTIVE ENERGY (-) [VARh] LSW			RW	
41894	1893	E REACTIVE ENERGY (-) [VARh] LLSW			RW	
41895	1894	E ACTIVE ENERGY [Wh] MMSW	3PH	Total Active Energy [Wh]	RW	SIGNED64
41896	1895	E ACTIVE ENERGY [Wh] MSW			RW	
41897	1896	E ACTIVE ENERGY [Wh] LSW			RW	
41898	1897	E ACTIVE ENERGY [Wh] LLSW			RW	
41899	1898	E REACTIVE ENERGY [VARh] MMSW	3PH	Total Reactive Energy [Varh]	RW	SIGNED64
41900	1899	E REACTIVE ENERGY [VARh] MSW			RW	
41901	1900	E REACTIVE ENERGY [VARh] LSW			RW	
41902	1901	E REACTIVE ENERGY [VARh] LLSW			RW	
41903	1902	E APPARENT ENERGY [VAh] MMSW	3PH	Total Apparent Energy [Vah]	RW	SIGNED64
41904	1903	E APPARENT ENERGY [VAh] MSW			RW	
41905	1904	E APPARENT ENERGY [VAh] LSW			RW	
41906	1905	E APPARENT ENERGY [VAh] LLSW			RW	
41923	1922	THD I AVG MSW	L1	Average Current THD calculated over the configured average time	RO	FLOAT32
41924	1923	THD I AVG LSW			RO	
41925	1924	THD I AVG MIN MSW	L1	Minimum Current THD calculated over the configured average time	RW	FLOAT32
41926	1925	THD I AVG MIN LSW			RW	
41927	1926	THD I AVG MAX MSW	L1		RW	FLOAT32

ADDRESS (4x)	ADDRESS OFFSET	REGISTER	PHASE	DESCRIPTION	W/R	TYPE
41928	1927	THD I AVG MAX LSW		Maximum Current THD calculated over the configured average time	RW	
41929	1928	THD I MIN MSW	L1	Minimum Current THD since device power up	RW	FLOAT32
41930	1929	THD I MIN LSW			RW	
41931	1930	THD I MAX MSW	L1	Maximum Current THD since device power up	RW	FLOAT32
41932	1931	THD I MAX LSW			RW	
41933	1932	THD I AVG MSW	L2	Average Current THD calculated over the configured average time	RO	FLOAT32
41934	1933	THD I AVG LSW			RO	
41935	1934	THD I AVG MIN MSW	L2	Minimum Current THD calculated over the configured average time	RW	FLOAT32
41936	1935	THD I AVG MIN LSW			RW	
41937	1936	THD I AVG MAX MSW	L2	Maximum Current THD calculated over the configured average time	RW	FLOAT32
41938	1937	THD I AVG MAX LSW			RW	
41939	1938	THD I MIN MSW	L2	Minimum Current THD since device power up	RW	FLOAT32
41940	1939	THD I MIN LSW			RW	
41941	1940	THD I MAX MSW	L2	Maximum Current THD since device power up	RW	FLOAT32
41942	1941	THD I MAX LSW			RW	
41943	1942	THD I AVG MSW	L3	Average Current THD calculated over the configured average time	RO	FLOAT32
41944	1943	THD I AVG LSW			RO	
41945	1944	THD I AVG MIN MSW	L3	Minimum Current THD calculated over the configured average time	RW	FLOAT32
41946	1945	THD I AVG MIN LSW			RW	
41947	1946	THD I AVG MAX MSW	L3	Maximum Current THD calculated over the configured average time	RW	FLOAT32
41948	1947	THD I AVG MAX LSW			RW	
41949	1948	THD I MIN MSW	L3	Minimum Current THD since device power up	RW	FLOAT32
41950	1949	THD I MIN LSW			RW	
41951	1950	THD I MAX MSW	L3	Maximum Current THD since device power up	RW	FLOAT32
41952	1951	THD I MAX LSW			RW	
41953	1952	THD I AVG MSW	L1	Average Voltage THD calculated over the configured average time	RO	FLOAT32
41954	1953	THD V AVG LSW			RO	
41955	1954	THD V AVG MIN MSW	L1		RW	FLOAT32

ADDRESS (4x)	ADDRESS OFFSET	REGISTER	PHASE	DESCRIPTION	W/R	TYPE
41956	1955	THD V AVG MIN LSW		Minimum Voltage THD calculated over the configured average time	RW	
41957	1956	THD V AVG MAX MSW	L1	Maximum Voltage THD calculated over the configured average time	RW	FLOAT32
41958	1957	THD V AVG MAX LSW			RW	
41959	1958	THD V MIN MSW	L1	Minimum Voltage THD since device power up	RW	FLOAT32
41960	1959	THD V MIN LSW			RW	
41961	1960	THD V MAX MSW	L1	Maximum Voltage THD since device power up	RW	FLOAT32
41962	1961	THD V MAX LSW			RW	
41963	1962	THD I AVG MSW	L2	Average Voltage THD calculated over the configured average time	RO	FLOAT32
41964	1963	THD V AVG LSW			RO	
41965	1964	THD V AVG MIN MSW	L2	Minimum Voltage THD calculated over the configured average time	RW	FLOAT32
41966	1965	THD V AVG MIN LSW			RW	
41967	1966	THD V AVG MAX MSW	L2	Maximum Voltage THD calculated over the configured average time	RW	FLOAT32
41968	1967	THD V AVG MAX LSW			RW	
41969	1968	THD V MIN MSW	L2	Minimum Voltage THD since device power up	RW	FLOAT32
41970	1969	THD V MIN LSW			RW	
41971	1970	THD V MAX MSW	L2	Maximum Voltage THD since device power up	RW	FLOAT32
41972	1971	THD V MAX LSW			RW	
41973	1972	THD I AVG MSW	L3	Average Voltage THD calculated over the configured average time	RO	FLOAT32
41974	1973	THD V AVG LSW			RO	
41975	1974	THD V AVG MIN MSW	L3	Minimum Voltage THD calculated over the configured average time	RW	FLOAT32
41976	1975	THD V AVG MIN LSW			RW	
41977	1976	THD V AVG MAX MSW	L3	Maximum Voltage THD calculated over the configured average time	RW	FLOAT32
41978	1977	THD V AVG MAX LSW			RW	
41979	1978	THD V MIN MSW	L3	Minimum Voltage THD since device power up	RW	FLOAT32
41980	1979	THD V MIN LSW			RW	
41981	1980	THD V MAX MSW	L3	Maximum Voltage THD since device power up	RW	FLOAT32
41982	1981	THD V MAX LSW			RW	
41995	1994	Vsys [V] MSW	3PH		RW	FLOAT32

ADDRESS (4x)	ADDRESS OFFSET	REGISTER	PHASE	DESCRIPTION	W/R	TYPE
41996	1995	Vsys [V] LSW		System Voltage (VL1+VL2+VL3)/3	RW	
41997	1996	Isys [A] MSW	3PH	System Current (IL1+IL2+IL3)	RW	FLOAT32
41998	1997	Isys [A] LSW			RW	
42019	2018	COUNTER 1 MSW	-	Digital Input 1 Counter	RW	UNSIGNED INT 32
42020	2019	COUNTER 1 LSW			RW	
42021	2020	COUNTER 2 MSW	-	Digital Input 2 Counter	RW	UNSIGNED INT 32
42022	2021	COUNTER 2 LSW			RW	
42023	2022	E ACTIVE ENERGY (+) [KWh] MSW	L1	Active Energy (Only +) Q1-Q4	RO	FLOAT 32
42024	2023	E ACTIVE ENERGY (+) [KWh] LSW			RO	
42025	2024	E ACTIVE ENERGY (+) [KWh] MSW	L2	Active Energy (Only +) Q1-Q4	RO	FLOAT 32
42026	2025	E ACTIVE ENERGY (+) [KWh] LSW			RO	
42027	2026	E ACTIVE ENERGY (+) [KWh] MSW	L3	Active Energy (Only +) Q1-Q4	RO	FLOAT 32
42028	2027	E ACTIVE ENERGY (+) [KWh] LSW			RO	
42029	2028	E ACTIVE ENERGY (-) [KWh] MSW	L1	Active Energy (Only -) Q2-Q3	RO	FLOAT 32
42030	2029	E ACTIVE ENERGY (-) [KWh] LSW			RO	
42031	2030	E ACTIVE ENERGY (-) [KWh] MSW	L2	Active Energy (Only -) Q2-Q3	RO	FLOAT 32
42032	2031	E ACTIVE ENERGY (-) [KWh] LSW			RO	
42033	2032	E ACTIVE ENERGY (-) [KWh] MSW	L3	Active Energy (Only -) Q2-Q3	RO	FLOAT 32
42034	2033	E ACTIVE ENERGY (-) [KWh] LSW			RO	
42035	2034	E REACTIVE ENERGY (+) [KVARh] MSW	L1	Reactive Energy (Only +) Q1-Q2	RO	FLOAT 32
42036	2035	E REACTIVE ENERGY (+) [KVARh] LSW			RO	
42037	2036	E REACTIVE ENERGY (+) [KVARh] MSW	L2	Reactive Energy (Only +) Q1-Q2	RO	FLOAT 32
42038	2037	E REACTIVE ENERGY (+) [KVARh] LSW			RO	
42039	2038	E REACTIVE ENERGY (+) [KVARh] MSW	L3	Reactive Energy (Only +) Q1-Q2	RO	FLOAT 32
42040	2039	E REACTIVE ENERGY (+) [KVARh] LSW			RO	
42041	2040	E REACTIVE ENERGY (-) [KVARh] MSW	L1	Reactive Energy (Only -) Q3-Q4	RO	FLOAT 32
42042	2041	E REACTIVE ENERGY (-) [KVARh] LSW			RO	
42043	2042	E REACTIVE ENERGY (-) [KVARh] LSW	L2	Reactive Energy (Only -)	RO	FLOAT32

ADDRESS (4x)	ADDRESS OFFSET	REGISTER	PHASE	DESCRIPTION	W/R	TYPE
42044	2043	E REACTIVE ENERGY (-) [KVARh] MSW		Q3-Q4	RO	
42045	2044	E REACTIVE ENERGY (-) [KVARh] LSW	L3	Reactive Energy (Only -) Q3-Q4	RO	FLOAT32
42046	2045	E REACTIVE ENERGY (-) [KVARh] MSW			RO	
42047	2046	E REACTIVE ENERGY (+)[KVARh] MSW	L1	Reactive Energy (Only +) Q1 [KVARh]	RO	FLOAT32
42048	2047	E REACTIVE ENERGY (+)[KVARh] LSW			RO	
42049	2048	E REACTIVE ENERGY (+)[KVARh] MSW	L2	Reactive Energy (Only +) Q1 [KVARh]	RO	FLOAT32
42050	2049	E REACTIVE ENERGY (+)[KVARh] LSW			RO	
42051	2050	E REACTIVE ENERGY (+)[KVARh] MSW	L3	Reactive Energy (Only +) Q1 [KVARh]	RO	FLOAT32
42052	2051	E REACTIVE ENERGY (+)[KVARh] LSW			RO	
42053	2052	E REACTIVE ENERGY (-) [KVARh] MSW	L1	Reactive Energy (Only -) Q3 [KVARh]	RO	FLOAT32
42054	2053	E REACTIVE ENERGY (-) [KVARh] LSW			RO	
42055	2054	E REACTIVE ENERGY (-) [KVARh] MSW	L2	Reactive Energy (Only -) Q3 [KVARh]	RO	FLOAT32
42056	2055	E REACTIVE ENERGY (-) [KVARh] LSW			RO	
42057	2056	E REACTIVE ENERGY (-) [KVARh] MSW	L3	Reactive Energy (Only -) Q3 [KVARh]	RO	FLOAT32
42058	2057	E REACTIVE ENERGY (-) [KVARh] LSW			RO	
42059	2058	E REACTIVE ENERGY (+) [KVARh] MSW	L1	Reactive Energy (Only +) Q2 [KVARh]	RO	FLOAT32
42060	2059	E REACTIVE ENERGY (+) [KVARh] LSW			RO	
42061	2060	E REACTIVE ENERGY (+) [KVARh] MSW	L2	Reactive Energy (Only +) Q2 [KVARh]	RO	FLOAT32
42062	2061	E REACTIVE ENERGY (+) [KVARh] LSW			RO	
42063	2062	E REACTIVE ENERGY (+) [KVARh] MSW	L3	Reactive Energy (Only +) Q2 [KVARh]	RO	FLOAT32
42064	2063	E REACTIVE ENERGY (+) [KVARh] LSW			RO	
42065	2064	E REACTIVE ENERGY (-) [KVARh] MSW	L1	Reactive Energy (Only -) Q4 [KVARh]	RO	FLOAT32
42066	2065	E REACTIVE ENERGY (-) [KVARh] LSW			RO	
42067	2066	E REACTIVE ENERGY (-) [KVARh] MSW	L2	Reactive Energy (Only -) Q4 [KVARh]	RO	FLOAT32

ADDRESS (4x)	ADDRESS OFFSET	REGISTER	PHASE	DESCRIPTION	W/R	TYPE
42068	2067	E REACTIVE ENERGY (-) [KVARh] LSW			RO	
42069	2068	E REACTIVE ENERGY (-) [KVARh] MSW	L3	Reactive Energy (Only -) Q4 [KVARh]	RO	FLOAT32
42070	2069	E REACTIVE ENERGY (-) [KVARh] LSW			RO	
42071	2070	TOT E ACTIVE ENERGY [KWh] MSW	L1	Total Active Energy [KWh]	RO	FLOAT32
42072	2071	TOT E ACTIVE ENERGY [KWh] LSW			RO	
42073	2072	TOT E ACTIVE ENERGY [KWh] MSW	L2	Total Active Energy [KWh]	RO	FLOAT32
42074	2073	TOT E ACTIVE ENERGY [KWh] LSW			RO	
42075	2074	TOT E ACTIVE ENERGY [KWh] MSW	L3	Total Active Energy [KWh]	RO	FLOAT32
42076	2075	TOT E ACTIVE ENERGY [KWh] LSW			RO	
42077	2076	TOT E REACTIVE ENERGY [KVARh]MSW	L1	Total Reactive Energy [KVARh]	RO	FLOAT32
42078	2077	TOT E REACTIVE ENERGY [KVARh]LSW			RO	
42079	2078	TOT E REACTIVE ENERGY [KVARh]MSW	L2	Total Reactive Energy [KVARh]	RO	FLOAT32
42080	2079	TOT E REACTIVE ENERGY [KVARh]LSW			RO	
42081	2080	TOT E REACTIVE ENERGY [KVARh]MSW	L3	Total Reactive Energy [KVARh]	RO	FLOAT32
42082	2081	TOT E REACTIVE ENERGY [KVARh]LSW			RO	
42083	2082	TOT E APPARENT ENERGY [KVARh] MSW	L1	Total Apparent Energy [VAh]	RO	FLOAT32
42084	2083	TOT E APPARENT ENERGY [KVARh] LSW			RO	
42085	2084	TOT E APPARENT ENERGY [KVARh] MSW	L2	Total Apparent Energy [VAh]	RO	FLOAT32
42086	2085	TOT E APPARENT ENERGY [KVARh] LSW			RO	
42087	2086	TOT E APPARENT ENERGY [KVARh] MSW	L3	Total Apparent Energy [VAh]	RO	FLOAT32
42088	2087	TOT E APPARENT ENERGY [KVARh] LSW			RO	
42089	2088	E ACTIVE ENERGY (+) [KWh] MSW	3PH	Active Energy (Only +) Q1-Q4 [KWh]	RO	FLOAT32
42090	2089	E ACTIVE ENERGY (+) [KWh] LSW			RO	
42091	2090	E ACTIVE ENERGY (-) [KWh] MSW	3PH	Active Energy (Only -) Q2-Q3 [KWh]	RO	FLOAT32
42092	2091	E ACTIVE ENERGY (-) [KWh] LSW			RO	

ADDRESS (4x)	ADDRESS OFFSET	REGISTER	PHASE	DESCRIPTION	W/R	TYPE
42093	2092	E REACTIVE ENERGY (+) [KVARh] MSW	3PH	Reactive Energy (Only +) Q1-Q2 [KWh]	RO	FLOAT32
42094	2093	E REACTIVE ENERGY (+) [KVARh] LSW			RO	
42095	2094	E REACTIVE ENERGY (-) [KVARh] MSW	3PH	Reactive Energy (Only -) Q3-Q4 [KWh]	RO	FLOAT32
42096	2095	E REACTIVE ENERGY (-) [KVARh] LSW			RO	
42097	2096	TOT E ACTIVE ENERGY [KWh] MSW	3PH	Total Active Energy [KWh]	RO	FLOAT32
42098	2097	TOT E ACTIVE ENERGY [KWh] LSW			RO	
42099	2098	TOT E REACTIVE ENERGY [KVARh] MSW	3PH	Total Reactive Energy [KVARh]	RO	FLOAT32
42100	2099	TOT E REACTIVE ENERGY [KVARh] LSW			RO	
42101	2100	TOT E APPARENT ENERGY [KVAh] MSW	3PH	Total Apparent Energy [KVAh]	RO	FLOAT32
42102	2101	TOT E APPARENT ENERGY [KVAh] LSW			RO	
42103	2102	TOT E REACTIVE ENERGY (+) ABSORBED [KVARh] MSW	3PH	Total Absorbed Reactive Energy (+) [KVARh]	RO	FLOAT32
42104	2103	TOT E REACTIVE ENERGY (+) ABSORBED [KVARh] LSW			RO	
42105	2104	TOT E REACTIVE ENERGY (-) ABSORBED [KVARh] MSW	3PH	Total Absorbed Reactive Energy (-) [KVARh]	RO	FLOAT32
42106	2105	TOT E REACTIVE ENERGY (-) ABSORBED [KVARh] LSW			RO	
42107	2106	TOT E REACTIVE ENERGY (+) DELIVERED [KVARh] MSW	3PH	Total Delivered Reactive Energy (+) [KVARh]	RO	FLOAT32
42108	2107	TOT E REACTIVE ENERGY (+) DELIVERED [KVARh] LSW			RO	
42109	2108	TOT E REACTIVE ENERGY (-) DELIVERED [KVARh] MSW	3PH	Total Delivered Reactive Energy (-) [KVARh]	RO	FLOAT32
42110	2109	TOT E REACTIVE ENERGY (-) DELIVERED [KVARh] LSW			RO	
45075	5074	DEMAND VALUE [min]	-	Value of the demand value for the average [minutes]. The modification is enabled after a reboot.	RW*	UNSIGNED INT 32

20. **PROTOCOLLO DI COMUNICAZIONE PROFINET IO (SOLO MODELLI R203-P)**

Tipo di protocollo: Class A Device, Cyclic Real-time (RT) and Acyclic Data

20.1. **CREAZIONE DI UN PROGETTO CON PLC SIEMENS (TIA PORTAL 16) (SOLO MODELLI R203-P)**

Creiamo un nuovo progetto:

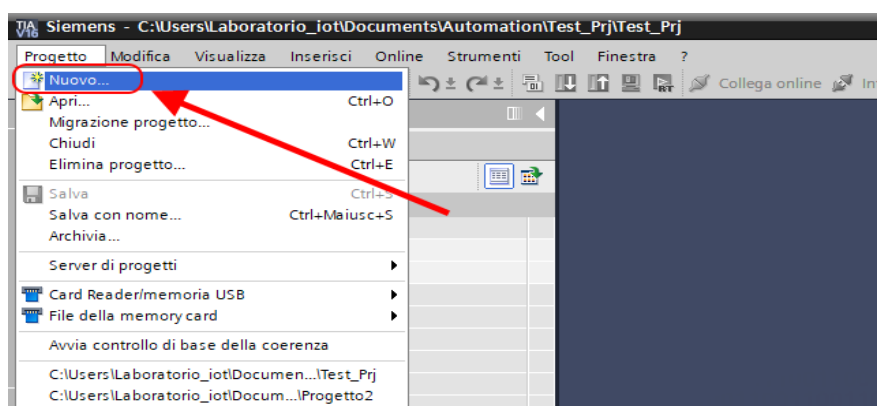

20.1.1. **INSTALLAZIONE DEL FILE GSDML**

Installiamo il file GSDML del prodotto Seneca

(è possibile ottenere il file nella pagina web del dispositivo nel sito www.seneca.it) :

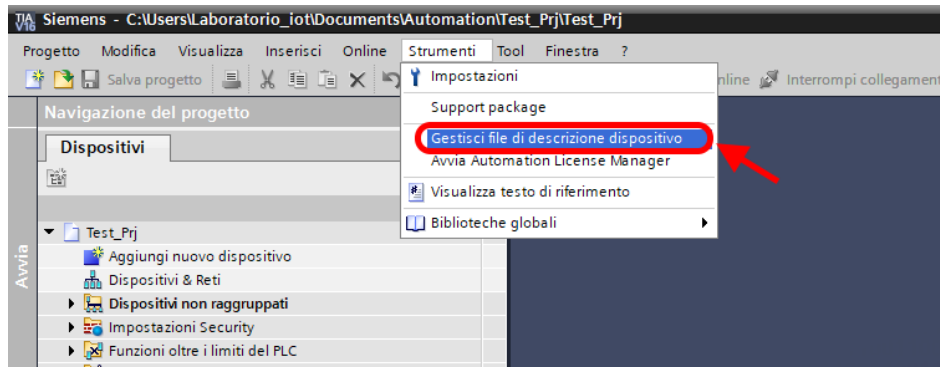

Puntiamo alla directory dove è presente il file e premiamo OK, successivamente comparirà l'elenco dei file GSD presenti nella cartella:

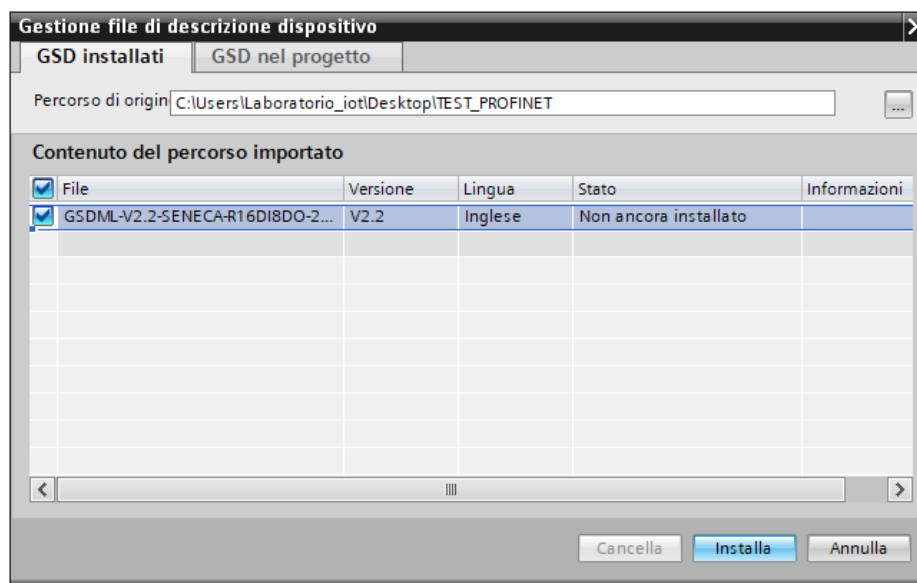

Facciamo click, quindi, su "installa".

20.1.2. **INSERIMENTO DEL PLC SIEMENS NEL PROGETTO**

Ora inseriamo il PLC Siemens (nel nostro esempio un SIEMATIC S7 1200), premiamo su "Aggiungi nuovo dispositivo...":

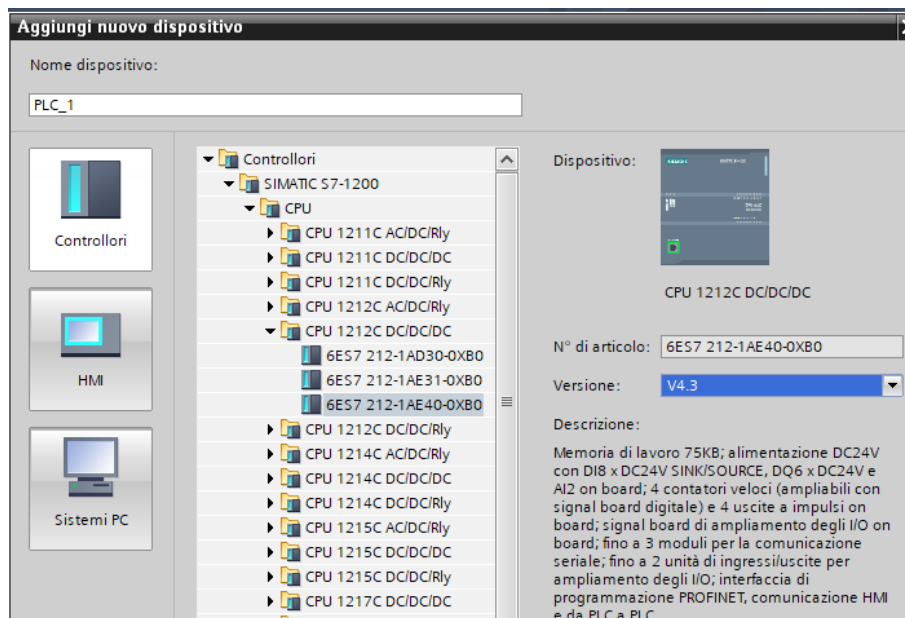
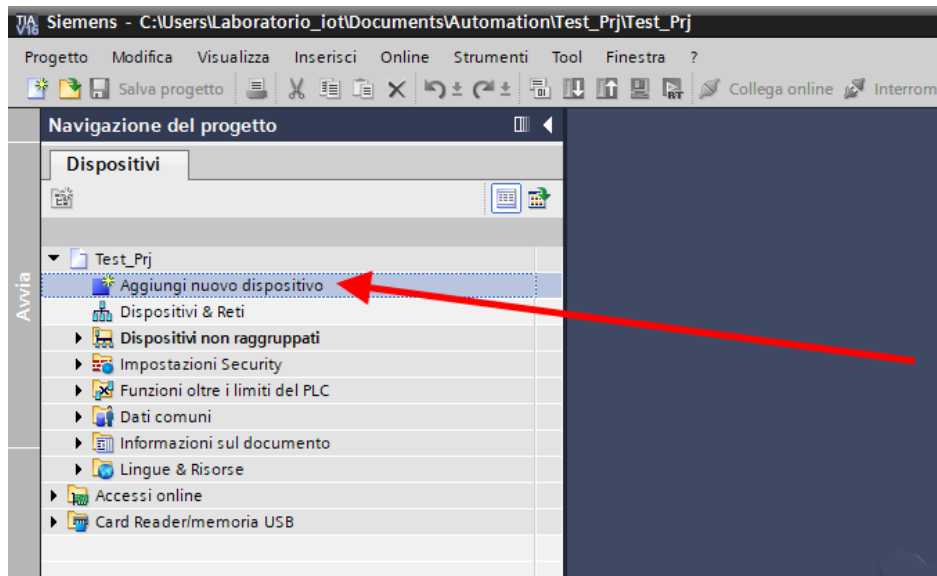

Confermiamo e otteniamo l'inserimento del PLC nel rack:

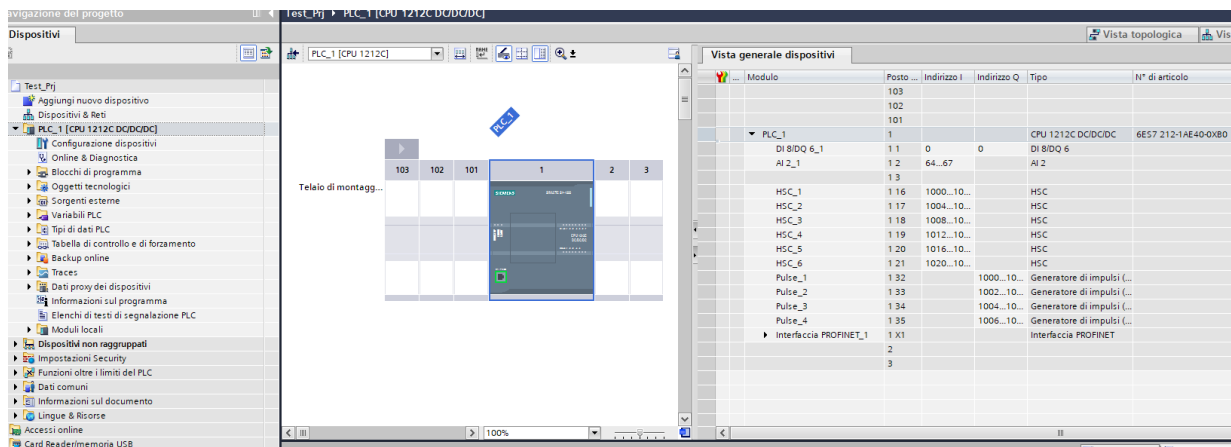

Ora clicchiamo sul PLC e selezioniamo Interfaccia Profinet -> Indirizzi Ethernet:

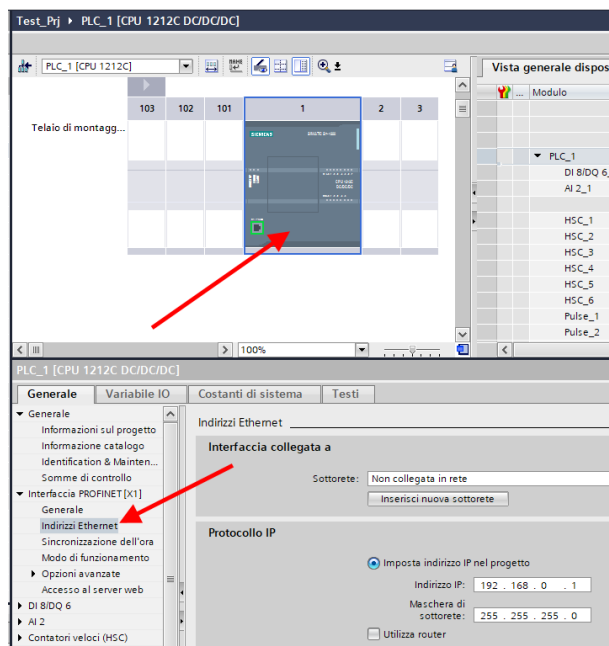

Ora Impostiamo l'IP che desideriamo (nel nostro caso 192.168.90.44) e la sottorete del PLC:

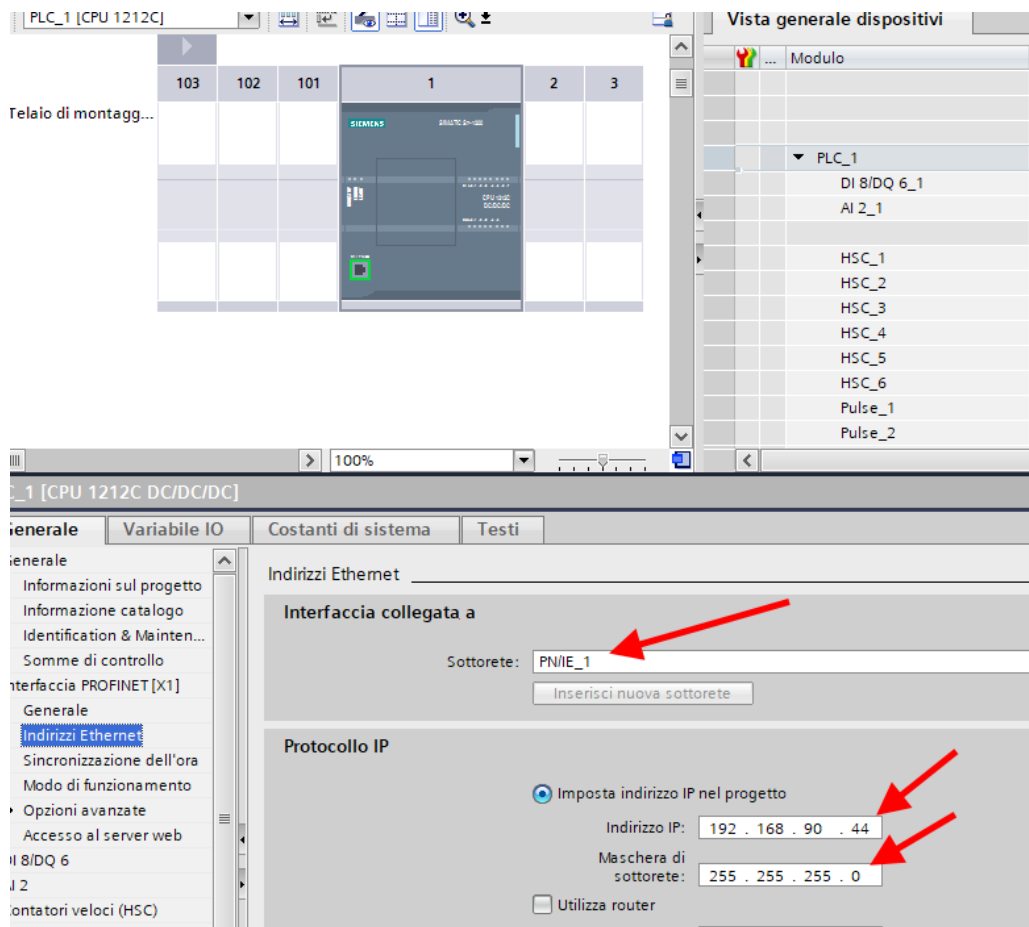

Ora passiamo alla vista di rete:

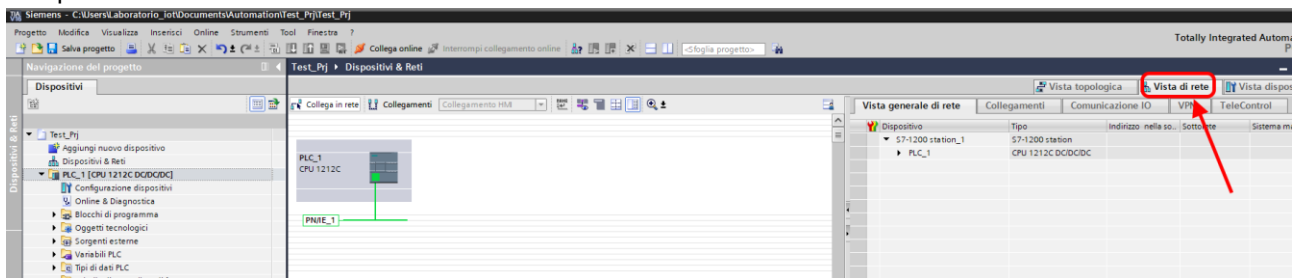

20.1.3. INSERIMENTO DELL'IO PROFINET SENECA

Sulla destra selezioniamo "Catalogo Hardware" e poi sotto "Ulteriore apparecchiatura da campo" ->PROFINET IO -> Sensors -> Seneca S.R.L. -> Seneca R-Series Devices -> R-203-P Ethernet I/O

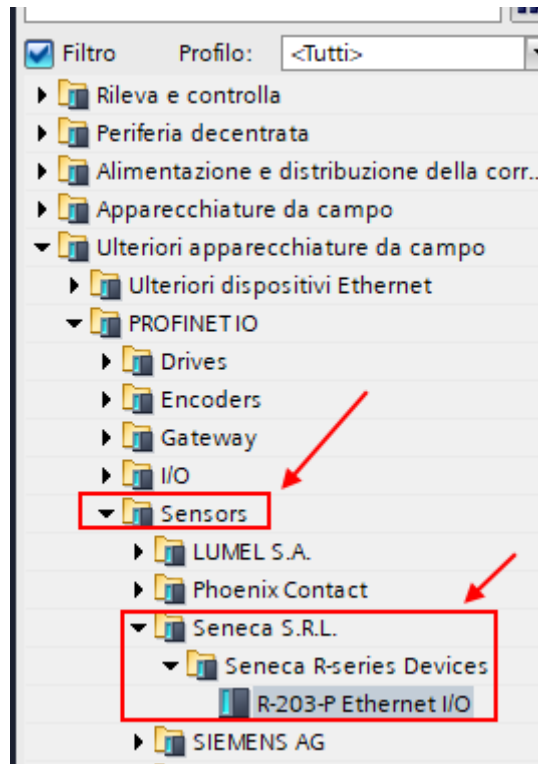

Trascinare il dispositivo sulla vista di rete:

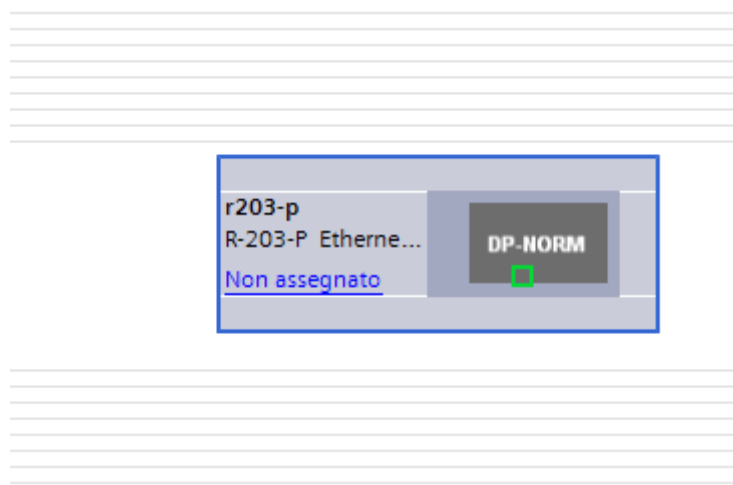

Ora lo associamo al PLC facendo click con il tasto sinistro del mouse su "Non assegnato" e poi selezioniamo il PLC:



Ora facciamo click due volte sul dispositivo Seneca e andiamo a configurare anche qui l'indirizzo IP (ad esempio 192.168.90.48):

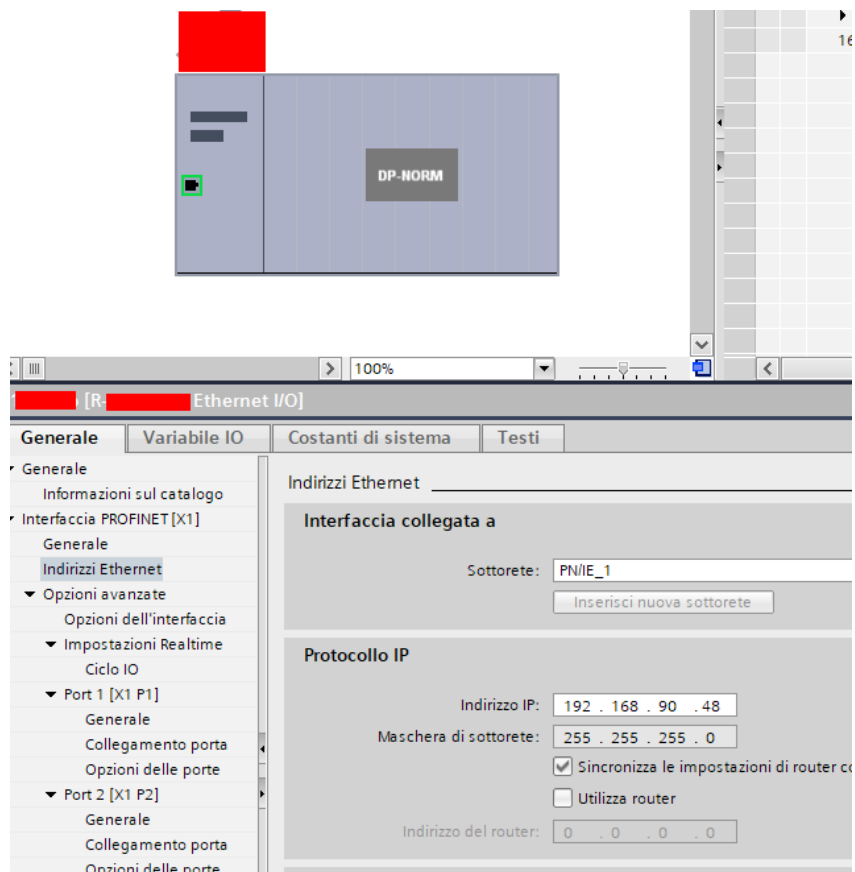

In Profinet i dispositivi vengono individuati dal loro nome quindi tasto destro sopra il dispositivo Seneca e selezioniamo la voce "Assegna nome al dispositivo"

ATTENZIONE!

EVITARE DI INSERIRE CARATTERI SPECIALI NEL NOME PROFINET DEL DISPOSITIVO

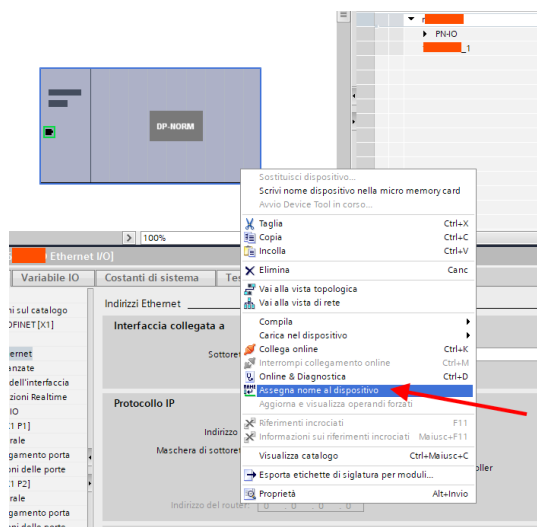

Effettuiamo lo scan della rete con "Aggiorna elenco" impostiamo (se necessario) il nome del dispositivo con "Assegna nome".

20.1.4. CONFIGURAZIONE DEI PARAMETRI DEL DISPOSITIVO SENECA

È anche possibile configurare direttamente l'IO del dispositivo senza alcun software esterno.
Per configurare il dispositivo fare click sull'IO in modo da far comparire i "Parametri dell'unità":

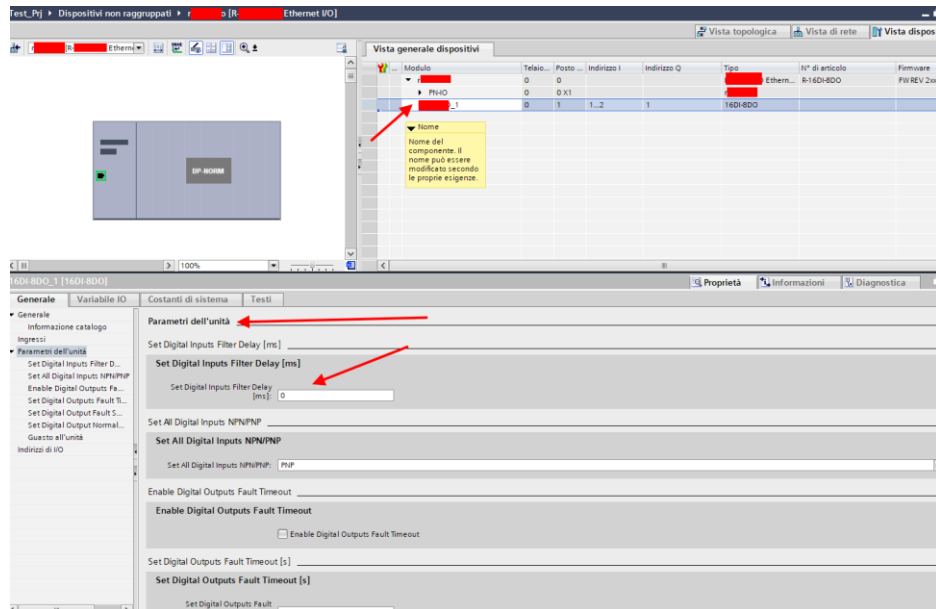

Al prossimo avvio il PLC invierà la configurazione voluta al dispositivo.

20.1.5. **PARAMETRI DI CONFIGURAZIONE DEL FILE GSDML**

CONNECTION TYPE

Imposta il tipo di connessione da effettuare.

TA TYPE

Seleziona il tipo di sensore e il valore del secondario del TA da utilizzare tra:

TA con uscita corrente

TA con uscita in mV

Sensore Rogowski

TA RATIO

Imposta l'eventuale rapporto di TA, il valore da inserire è relativo al primario, esempio:

Se si è installato un TA 50/5 andrà inserito come primario il valore 50 e sul parametro "TA TYPE" il valore 5.

TV TYPE

Imposta il tipo di Trasformatore di Tensione

TV RATIO

Imposta l'eventuale rapporto di TV

NETWORK FREQUENCY [Hz]

Imposta l'impianto a 50 o 60 Hz.

AVERAGE POWER WINDOW

Imposta il tempo su cui effettuare la misura dei valori medi

USER CALIBRATION VOLTAGE

Imposta un eventuale coefficiente moltiplicativo per la misura di tensione.

USER CALIBRATION CURRENT

Imposta un eventuale coefficiente moltiplicativo per la misura di corrente.

CUTOFF CURRENT [A]

Imposta un valore di corrente (al primario) sotto il quale i contatori vengono fermati.

USER CALIBRATION ACTIVE ENERGY

Imposta un eventuale coefficiente moltiplicativo per l'energia attiva.

USER CALIBRATION REACTIVE ENERGY

Imposta un eventuale coefficiente moltiplicativo per l'energia reattiva.

AO MODE

Imposta se l'uscita analogica è configurata in Tensione [0V...10V] o Corrente [0mA...20mA].

20.1.6. **DATI I/O R203-P**

È ora possibile scegliere quale gruppi di variabili pubblicare in Profinet.
Una volta inserito il dispositivo comparirà:

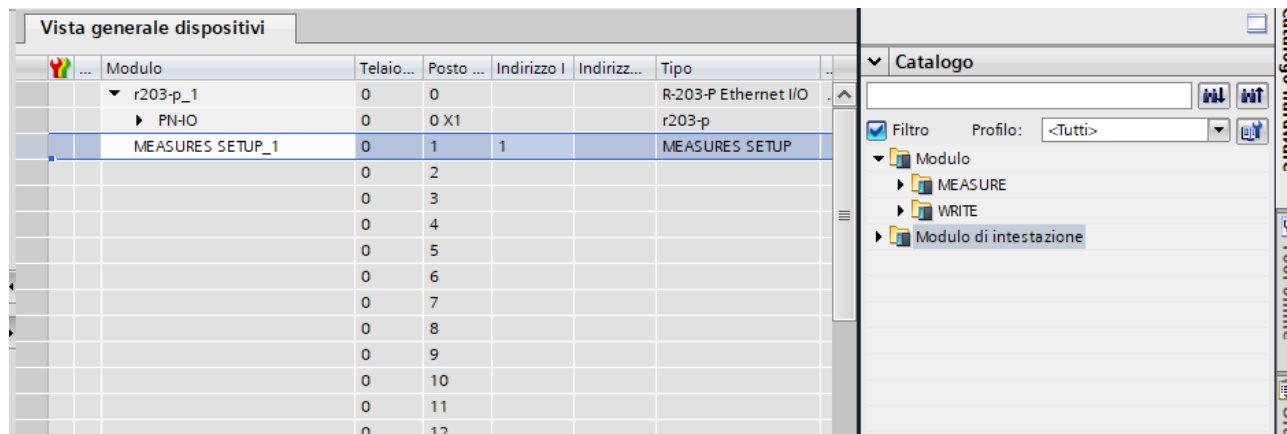

MEASURE_SETUP è un gruppo di variabili sempre presente, mentre nella destra sono presenti Variabili di "MEASURE" e "WRITE".

È possibile aggiungere fino a 15 gruppi di variabili.

I gruppi di variabili sono opzionali, quelli che è possibile aggiungere sono:

MEASURE SETUP (Sempre presente)

Fornisce informazioni generali sullo stato degli ingressi e del dispositivo:

Name	Data Type	Display as Bits	Length [Bytes]
STATUS	Unsigned8	Bit 0: CYCLIC PHASE SENSOR ERROR Bit 1: CURRENT CUT OFF Bit 2: CURRENT ERROR L1 Bit 3: CURRENT ERROR L2 Bit 4: CURRENT ERROR L3 Bit 5: LINE 1 VOLTAGE/CURRENT CONNECTION ERROR Bit 6: LINE 2 VOLTAGE/CURRENT CONNECTION ERROR Bit 7: LINE 3 VOLTAGE/CURRENT CONNECTION ERROR	1

Per maggiori informazioni sul significato di questi valori booleani fare riferimento al capitolo 14.

VOLTAGE

Fornisce i valori delle tensioni concatenate e stellate:

Name	Data Type	Display as Bits	Length [Bytes]
VL1L2	Float32	No	4
VL2L3	Float32	No	4
VL3L1	Float32	No	4
VL1N	Float32	No	4
VL2N	Float32	No	4
VL3N	Float32	No	4

CURRENT

Fornisce i valori delle correnti di fase e del neutro in [A]:

Name	Data Type	Display as Bits	Length [Bytes]
IL1	Float32	<input type="checkbox"/> No	4
IL2	Float32	<input type="checkbox"/> No	4
IL3	Float32	<input type="checkbox"/> No	4
IN	Float32	<input type="checkbox"/> No	4

ACTIVE REACTIVE APPARENT TOTAL POWER

Fornisce i valori della Potenza attiva, reattiva ed apparente totali in [KW], [KVAR], [KVA]:

Name	Data Type	Display as Bits	Length [Bytes]
ACTIVE POWER L1	Float32	<input type="checkbox"/> No	4
ACTIVE POWER L2	Float32	<input type="checkbox"/> No	4
ACTIVE POWER L3	Float32	<input type="checkbox"/> No	4
REACTIVE POWER L1	Float32	<input type="checkbox"/> No	4
REACTIVE POWER L2	Float32	<input type="checkbox"/> No	4
REACTIVE POWER L3	Float32	<input type="checkbox"/> No	4
APPARENT POWER L1	Float32	<input type="checkbox"/> No	4
APPARENT POWER L2	Float32	<input type="checkbox"/> No	4
APPARENT POWER L3	Float32	<input type="checkbox"/> No	4
TOTAL ACTIVE POWER	Float32	<input type="checkbox"/> No	4
TOTAL REACTIVE POWER	Float32	<input type="checkbox"/> No	4
TOTAL APPARENT POWER	Float32	<input type="checkbox"/> No	4

ANGLE

Fornisce i valori dello sfasamento dei vettori in [°]

Name	Data Type	Display as Bits	Length [Bytes]
ANGLE VI L1	Float32	<input type="checkbox"/> No	4
ANGLE VI L2	Float32	<input type="checkbox"/> No	4
ANGLE VI L3	Float32	<input type="checkbox"/> No	4
ANGLE VI L1 L2	Float32	<input type="checkbox"/> No	4
ANGLE VI L2 L3	Float32	<input type="checkbox"/> No	4
ANGLE VI L3 L1	Float32	<input type="checkbox"/> No	4

POWER FACTOR

Fornisce i valori del fattore di Potenza:

Name	Data Type	Display as Bits	Length [Bytes]
POWER FACTOR L1	Float32	<input type="checkbox"/> No	4
POWER FACTOR L2	Float32	<input type="checkbox"/> No	4
POWER FACTOR L3	Float32	<input type="checkbox"/> No	4
POWER FACTOR TOTAL	Float32	<input type="checkbox"/> No	4

FREQUENCY PERIOD

Fornisce i valori della frequenza [Hz] e del periodo [ms]:

Name	Data Type	Display as Bits	Length [Bytes]
FREQUENCY L1	Float32	<input type="checkbox"/> No	4
FREQUENCY L2	Float32	<input type="checkbox"/> No	4
FREQUENCY L3	Float32	<input type="checkbox"/> No	4
PERIOD L1	Float32	<input type="checkbox"/> No	4
PERIOD L2	Float32	<input type="checkbox"/> No	4
PERIOD L3	Float32	<input type="checkbox"/> No	4

THD

Fornisce la Total Harmonic Distortion in [%]

Name	Data Type	Display as Bits	Length [Bytes]
THD V L1	Float32	<input type="checkbox"/> No	4
THD V L2	Float32	<input type="checkbox"/> No	4
THD V L3	Float32	<input type="checkbox"/> No	4
THD I L1	Float32	<input type="checkbox"/> No	4
THD I L2	Float32	<input type="checkbox"/> No	4
THD I L3	Float32	<input type="checkbox"/> No	4

AVERAGE

Fornisce i valori mediati sul demand time configurato in [V], [A], [KW], [KVAR], [KVA]

Name	Data Type	Display as Bits	Length [Bytes]
AVG V L1	Float32	<input type="checkbox"/> No	4
AVG V L2	Float32	<input type="checkbox"/> No	4
AVG V L3	Float32	<input type="checkbox"/> No	4
AVG I L1	Float32	<input type="checkbox"/> No	4
AVG I L2	Float32	<input type="checkbox"/> No	4
AVG I L3	Float32	<input type="checkbox"/> No	4
AVG ACTIVE POWER 3PH	Float32	<input type="checkbox"/> No	4
AVG REACTIVE POWER 3PH	Float32	<input type="checkbox"/> No	4
AVG APPARENT POWER 3PH	Float32	<input type="checkbox"/> No	4

MIN

Fornisce i valori minimi delle misure in [V], [A], [KW], [KVAR], [KVA]:

Name	Data Type	Display as Bits	Length [Bytes]
MIN V L1	Float32	<input type="checkbox"/> No	4
MIN V L2	Float32	<input type="checkbox"/> No	4
MIN V L3	Float32	<input type="checkbox"/> No	4
MIN I L1	Float32	<input type="checkbox"/> No	4
MIN I L2	Float32	<input type="checkbox"/> No	4
MIN I L3	Float32	<input type="checkbox"/> No	4
MIN ACTIVE POWER 3PH	Float32	<input type="checkbox"/> No	4
MIN REACTIVE POWER 3PH	Float32	<input type="checkbox"/> No	4
MIN APPARENT POWER 3PH	Float32	<input type="checkbox"/> No	4

MAX

Fornisce i valori massimi delle misure in [V], [A], [KW], [KVAR], [KVA]:

Name	Data Type	Display as Bits	Length [Bytes]
MAX V L1	Float32	<input type="checkbox"/> No	4
MAX V L2	Float32	<input type="checkbox"/> No	4
MAX V L3	Float32	<input type="checkbox"/> No	4
MAX I L1	Float32	<input type="checkbox"/> No	4
MAX I L2	Float32	<input type="checkbox"/> No	4
MAX I L3	Float32	<input type="checkbox"/> No	4
MAX ACTIVE POWER 3PH	Float32	<input type="checkbox"/> No	4
MAX REACTIVE POWER 3PH	Float32	<input type="checkbox"/> No	4
MAX APPARENT POWER 3PH	Float32	<input type="checkbox"/> No	4

ENERGY ACTIVE PHASE

Fornisce i valori dell'energia attiva di fase separata per quadranti, positiva e negativa e totale in [KWh]:

Name	Data Type	Display as Bits	Length [Bytes]
ENERGY ACTIVE(+) Q1-Q4 L1	Float32	<input type="checkbox"/> No	4
ENERGY ACTIVE(+) Q1-Q4 L2	Float32	<input type="checkbox"/> No	4
ENERGY ACTIVE(+) Q1-Q4 L3	Float32	<input type="checkbox"/> No	4
ENERGY ACTIVE(-) Q2-Q3 L1	Float32	<input type="checkbox"/> No	4
ENERGY ACTIVE(-) Q2-Q3 L2	Float32	<input type="checkbox"/> No	4
ENERGY ACTIVE(-) Q2-Q3 L3	Float32	<input type="checkbox"/> No	4
ENERGY ACTIVE TOTAL L1	Float32	<input type="checkbox"/> No	4
ENERGY ACTIVE TOTAL L2	Float32	<input type="checkbox"/> No	4
ENERGY ACTIVE TOTAL L3	Float32	<input type="checkbox"/> No	4

ENERGY ACTIVE 3PH PHASE

Fornisce i valori dell'energia attiva trifase positiva e negativa e totale in [KWh]:

Name	Data Type	Display as Bits	Length [Bytes]
ENERGY ACTIVE 3PH (+) Q1-Q4	Float32	<input type="checkbox"/> No	4
ENERGY ACTIVE 3PH (-) Q2-Q3	Float32	<input type="checkbox"/> No	4
ENERGY ACTIVE TOTAL 3PH	Float32	<input type="checkbox"/> No	4

ENERGY REACTIVE Q1-Q2

Fornisce i valori dell'energia reattiva positiva in [KVARh]:

Name	Data Type	Display as Bits	Length [Bytes]
ENERGY REACTIVE(+) Q1-Q2 L1	Float32	<input type="checkbox"/> No	4
ENERGY REACTIVE(+) Q1-Q2 L2	Float32	<input type="checkbox"/> No	4
ENERGY REACTIVE(+) Q1-Q2 L3	Float32	<input type="checkbox"/> No	4
ENERGY ACTIVE 3PH (+) Q1-Q2	Float32	<input type="checkbox"/> No	4

ENERGY REACTIVE Q3-Q4

Fornisce i valori dell'energia reattiva negativa in [KVARh]:

Name	Data Type	Display as Bits	Length [Bytes]
ENERGY REACTIVE(-) Q3-Q4 L1	Float32	<input type="checkbox"/> No	4
ENERGY REACTIVE(-) Q3-Q4 L2	Float32	<input type="checkbox"/> No	4
ENERGY REACTIVE(-) Q3-Q4 L3	Float32	<input type="checkbox"/> No	4
ENERGY ACTIVE 3PH (-) Q3-Q4	Float32	<input type="checkbox"/> No	4

ENERGY REACTIVE Q1

Fornisce i valori dell'energia reattiva del quadrante Q1 di ciascuna fase in [KVARh]:

Name	Data Type	Display as Bits	Length [Bytes]
ENERGY REACTIVE(+) Q1 L1	Float32	<input type="checkbox"/> No	4
ENERGY REACTIVE(+) Q1 L2	Float32	<input type="checkbox"/> No	4
ENERGY REACTIVE(+) Q1 L3	Float32	<input type="checkbox"/> No	4

ENERGY REACTIVE Q2

Fornisce i valori dell'energia reattiva del quadrante Q2 di ciascuna fase in [KVARh]:

Name	Data Type	Display as Bits	Length [Bytes]
ENERGY REACTIVE(-) Q2 L1	Float32	<input type="checkbox"/> No	4
ENERGY REACTIVE(-) Q2 L2	Float32	<input type="checkbox"/> No	4
ENERGY REACTIVE(-) Q2 L3	Float32	<input type="checkbox"/> No	4

ENERGY REACTIVE Q3

Fornisce i valori dell'energia reattiva del quadrante Q3 di ciascuna fase in [KVARh]:

Name	Data Type	Display as Bits	Length [Bytes]
ENERGY REACTIVE(+) Q3 L1	Float32	<input type="checkbox"/> No	4
ENERGY REACTIVE(+) Q3 L2	Float32	<input type="checkbox"/> No	4
ENERGY REACTIVE(+) Q3 L3	Float32	<input type="checkbox"/> No	4

ENERGY REACTIVE Q4

Fornisce i valori dell'energia reattiva del quadrante Q4 di ciascuna fase in [KVARh]:

Name	Data Type	Display as Bits	Length [Bytes]
ENERGY REACTIVE(-) Q4 L1	Float32	<input type="checkbox"/> No	4
ENERGY REACTIVE(-) Q4 L2	Float32	<input type="checkbox"/> No	4
ENERGY REACTIVE(-) Q4 L3	Float32	<input type="checkbox"/> No	4

ENERGY REACTIVE TOTAL

Fornisce i valori dell'energia reattiva totale di ciascuna fase e trifase in [KVARh]:

Name	Data Type	Display as Bits	Length [Bytes]
ENERGY REACTIVE TOTAL L1	Float32	<input type="checkbox"/> No	4
ENERGY REACTIVE TOTAL L2	Float32	<input type="checkbox"/> No	4
ENERGY REACTIVE TOTAL L3	Float32	<input type="checkbox"/> No	4
ENERGY REACTIVE TOTAL 3PH	Float32	<input type="checkbox"/> No	4

ENERGY APPARENT TOTAL

Fornisce i valori dell'energia apparente totale di ciascuna fase e trifase in [KVAh]:

Name	Data Type	Display as Bits	Length [Bytes]
ENERGY APPARENT TOTAL L1	Float32	<input type="checkbox"/> No	4
ENERGY APPARENT TOTAL L2	Float32	<input type="checkbox"/> No	4
ENERGY APPARENT TOTAL L3	Float32	<input type="checkbox"/> No	4
ENERGY APPARENT TOTAL 3PH	Float32	<input type="checkbox"/> No	4

ENERGY REACTIVE ABSORBED TOTAL

Fornisce i valori dell'energia reattiva assorbita totale in [KVAh]:

Name	Data Type	Display as Bits	Length [Bytes]
ENERGY REACTIVE ABSORBED (+) TOTAL 3PH	Float32	<input type="checkbox"/> No	4
ENERGY REACTIVE ABSORBED (-) TOTAL 3PH	Float32	<input type="checkbox"/> No	4

ENERGY REACTIVE DELIVERED TOTAL

Fornisce i valori dell'energia reattiva totale fornita in [KVAh]:

Name	Data Type	Display as Bits	Length [Bytes]
ENERGY REACTIVE DELIVERED (+) TOTAL 3PH	Float32	<input type="checkbox"/> No	4
ENERGY REACTIVE DELIVERED (-) TOTAL 3PH	Float32	<input type="checkbox"/> No	4

DI

Fornisce il valore dei due ingressi digitali:

Name	Data Type	Display as Bits	Length [Bytes]
DIGITAL INPUT	Unsigned8	Bit 0: DIN.1 Bit 1: DIN.2 Bit 2: NONE Bit 3: NONE Bit 4: NONE Bit 5: NONE Bit 6: NONE Bit 7: NONE	1

DO

Stato (scrivibile) con il valore delle due uscite digitali:

Name	Data Type	Display as Bits	Length [Bytes]
DO	Unsigned8	Bit 0: DOUT.1 Bit 1: DOUT.2 Bit 2: NONE Bit 3: NONE Bit 4: NONE Bit 5: NONE Bit 6: NONE Bit 7: NONE	1

AO

Stato (scrivibile) con il valore dell'uscita analogica in [mA] oppure [V]:

Name	Data Type	Display as Bits	Length [Bytes]
AO VALUE	Float32	<input type="checkbox"/> No	4

Ora compiliamo, inviamo il progetto e andiamo online con il PLC.

21. **PROTOCOLLO DI COMUNICAZIONE ETHERNET/IP (SOLO MODELLI R203-E)**

EtherNet/IP (Ethernet Industrial Protocol) è un bus di campo aperto basato su CIP (Common Industrial Protocol), sviluppato da Rockwell Automation e ODVA (Open DeviceNet Vendor Association).

21.1. **CREAZIONE DI UN PROGETTO CON PLC ALLEN BRADLEY/ROCKWELL (RS-LOGIX5000 / STUDIO 5000 LOGIX DESIGNER 35.00.00)**

Una volta inserito il PLC nel progetto importiamo il file EDS del dispositivo R203 tramite il menù Tools-> EDS Hardware Installation Tool:

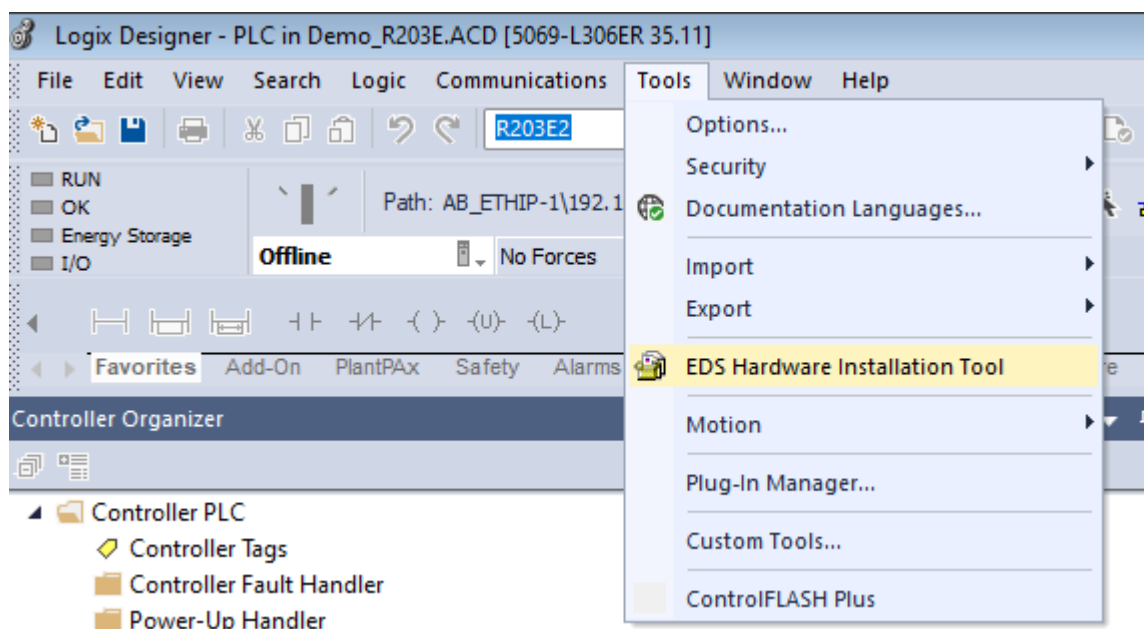

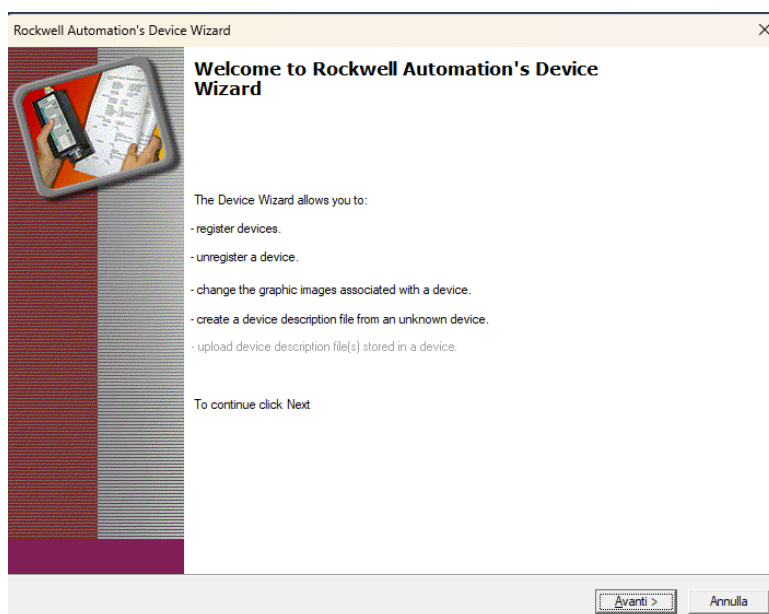

Premere “Avanti”, e selezioniamo di Aggiungere un nuovo dispositivo:

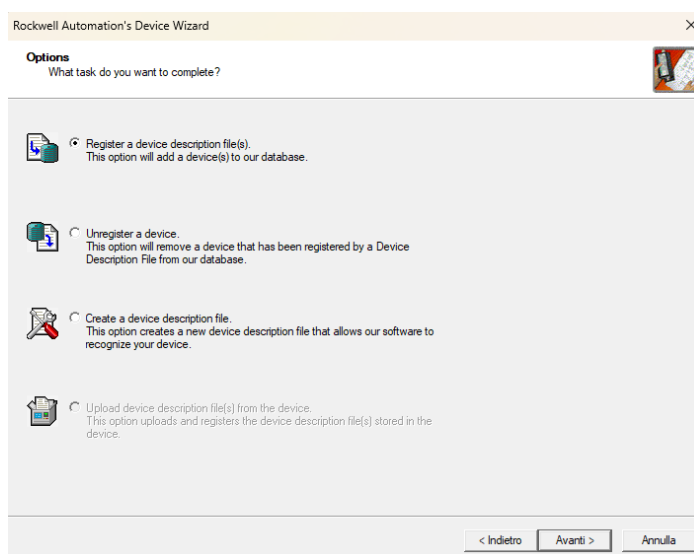

Selezioniamo di registrare un unico dispositivo e selezioniamo il file “R203-P.eds”

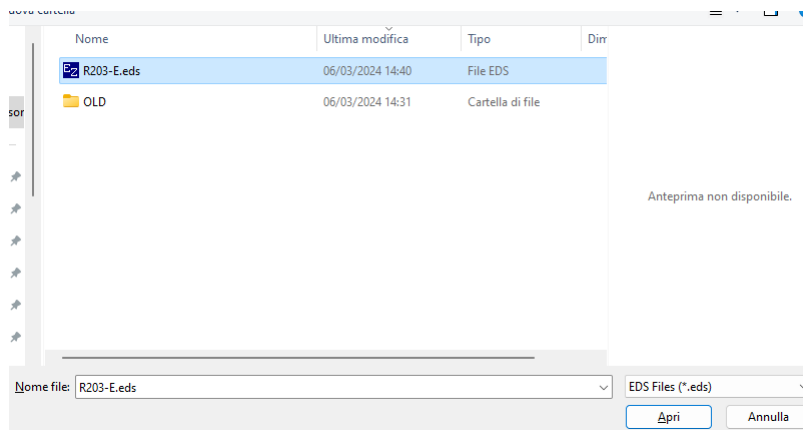
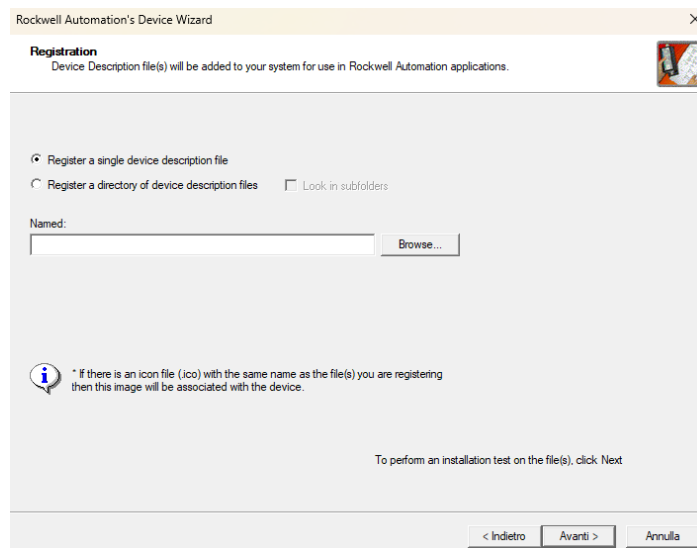

Selezioniamo “Apri” e poi “Avanti”:

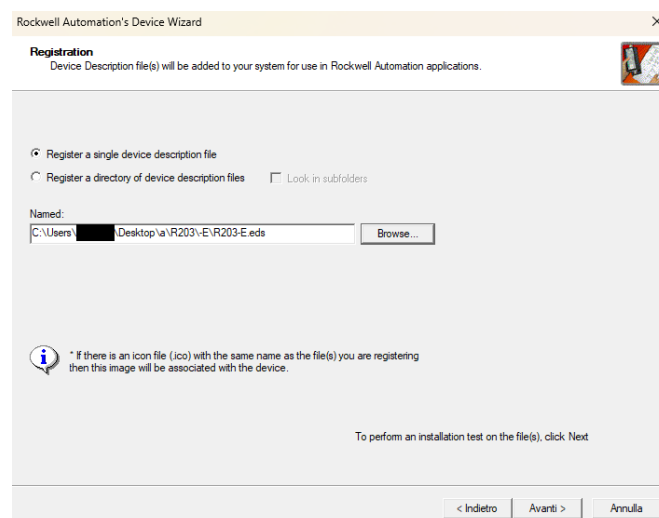

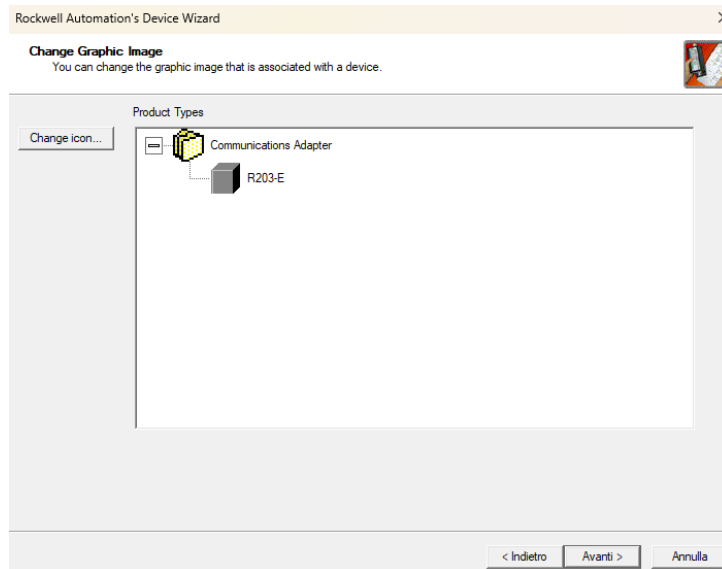

A questo punto il prodotto R203-E è stato inserito nel database dei dispositivi.

Ora andiamo con il mouse sopra la porta ethernet del PLC connesso al dispositivo e con il tasto destro selezioniamo “New Module...”:

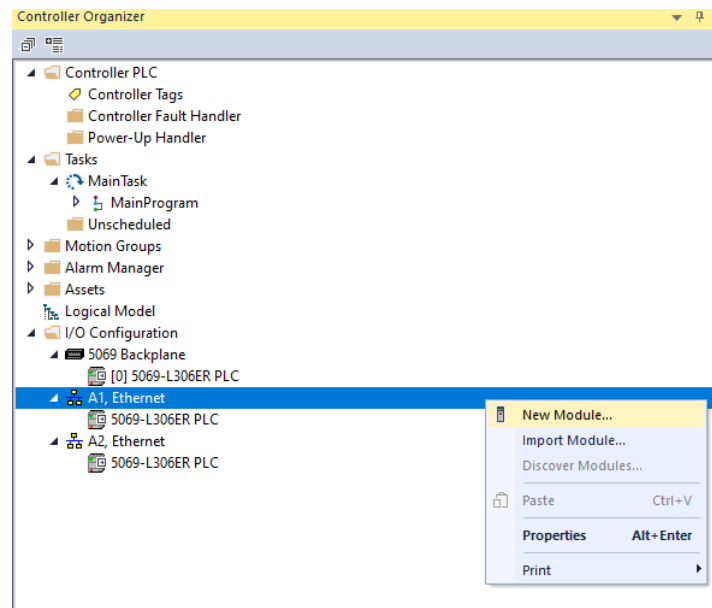

Ora selezioniamo il dispositivo R203-E:

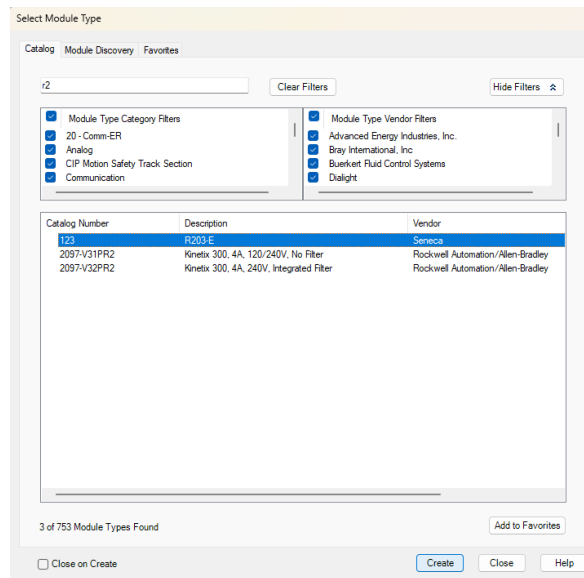

Diamo un nome al dispositivo ed inseriamo il suo indirizzo IP:

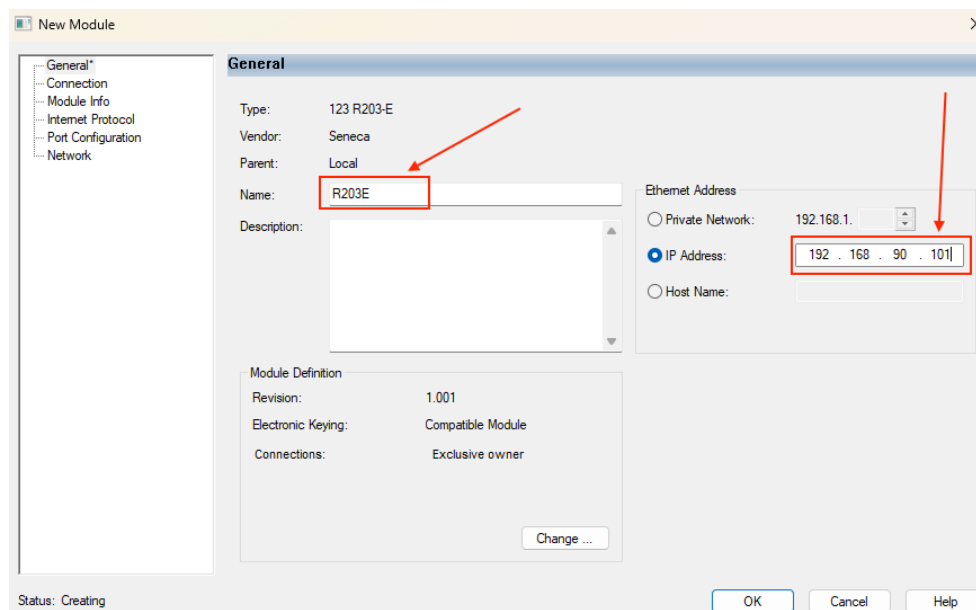

Confermando con OK il dispositivo viene aggiunto:

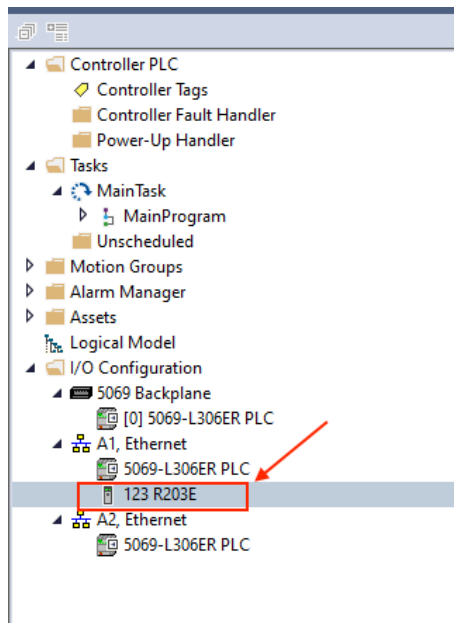

Per semplificare l'acquisizione delle misure e l'invio delle scritture al dispositivo importiamo gli User Data Defined relativi a R203-E:

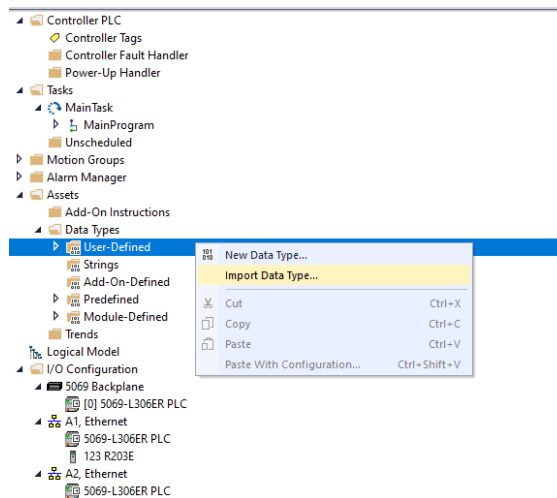

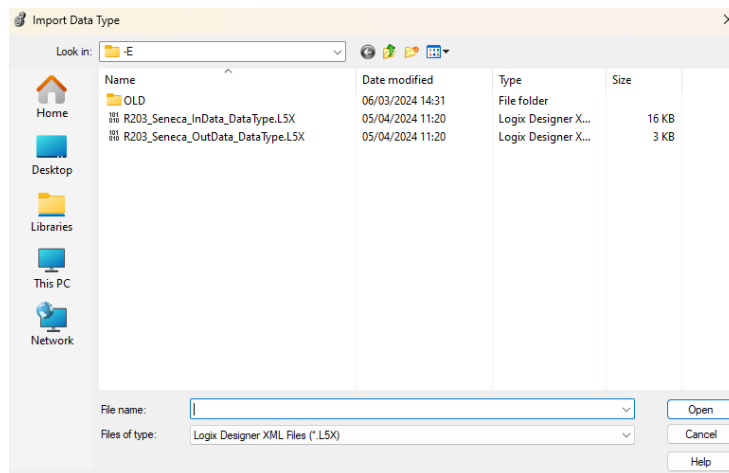

Il InData rappresenterà le misure che escono da R203 verso il PLC, OutData sono i tag che permettono di inviare comandi a R203:

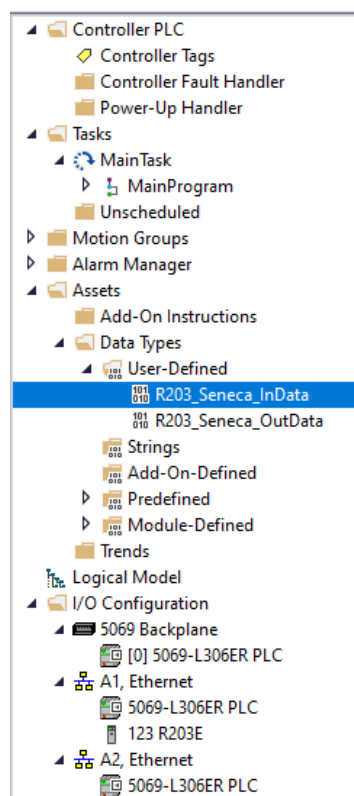

Ora definiamo le strutture “Misure” e “Uscite” con tipo di dato rispettivamente “R203_Seneca_InData” e “R203_Seneca_OutData”:

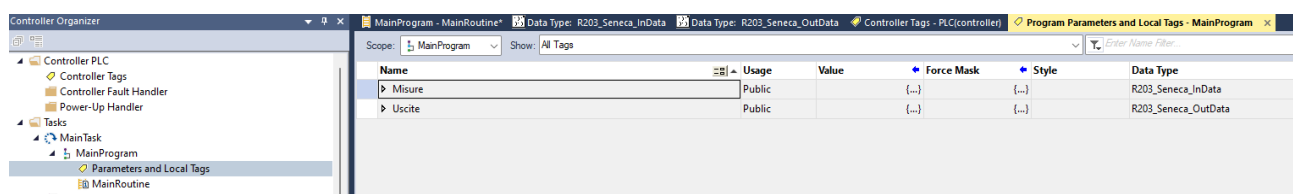

A questo punto definiamo un programma che copi le misure in arrivo da R203 nella struttura R203_Seneca_InData:

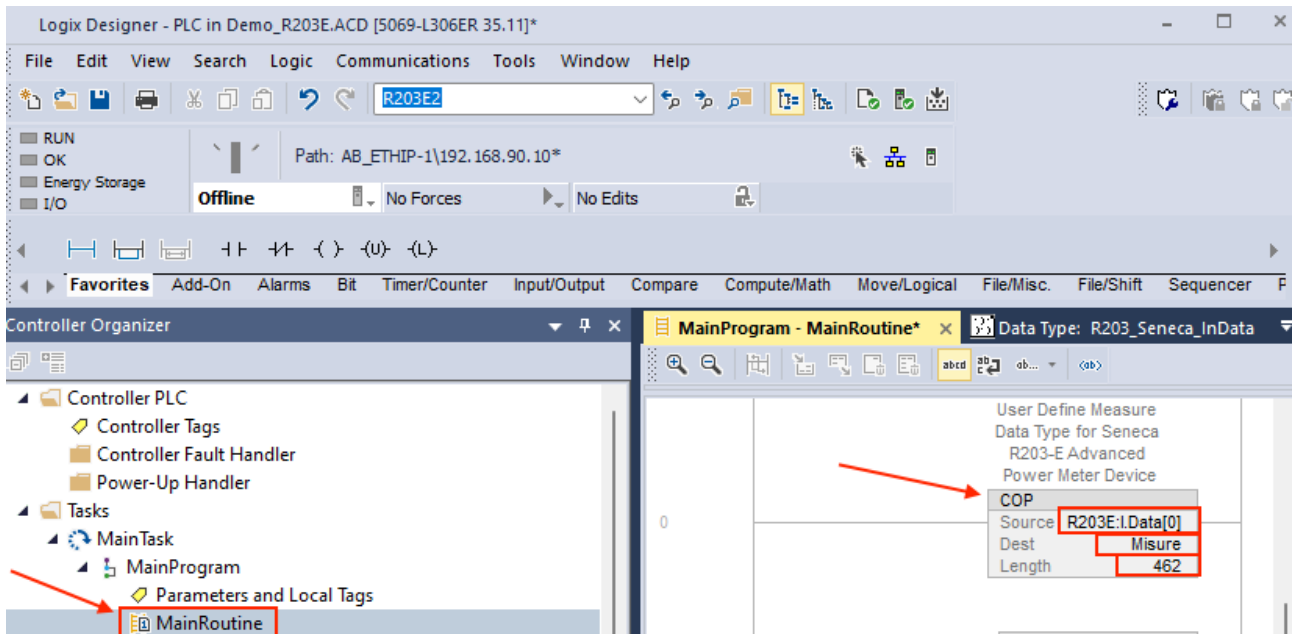

E poi effettuiamo la copia dei valori che comanderemo nella struttura R203_Seneca_OutData nei dati inviati al dispositivo:

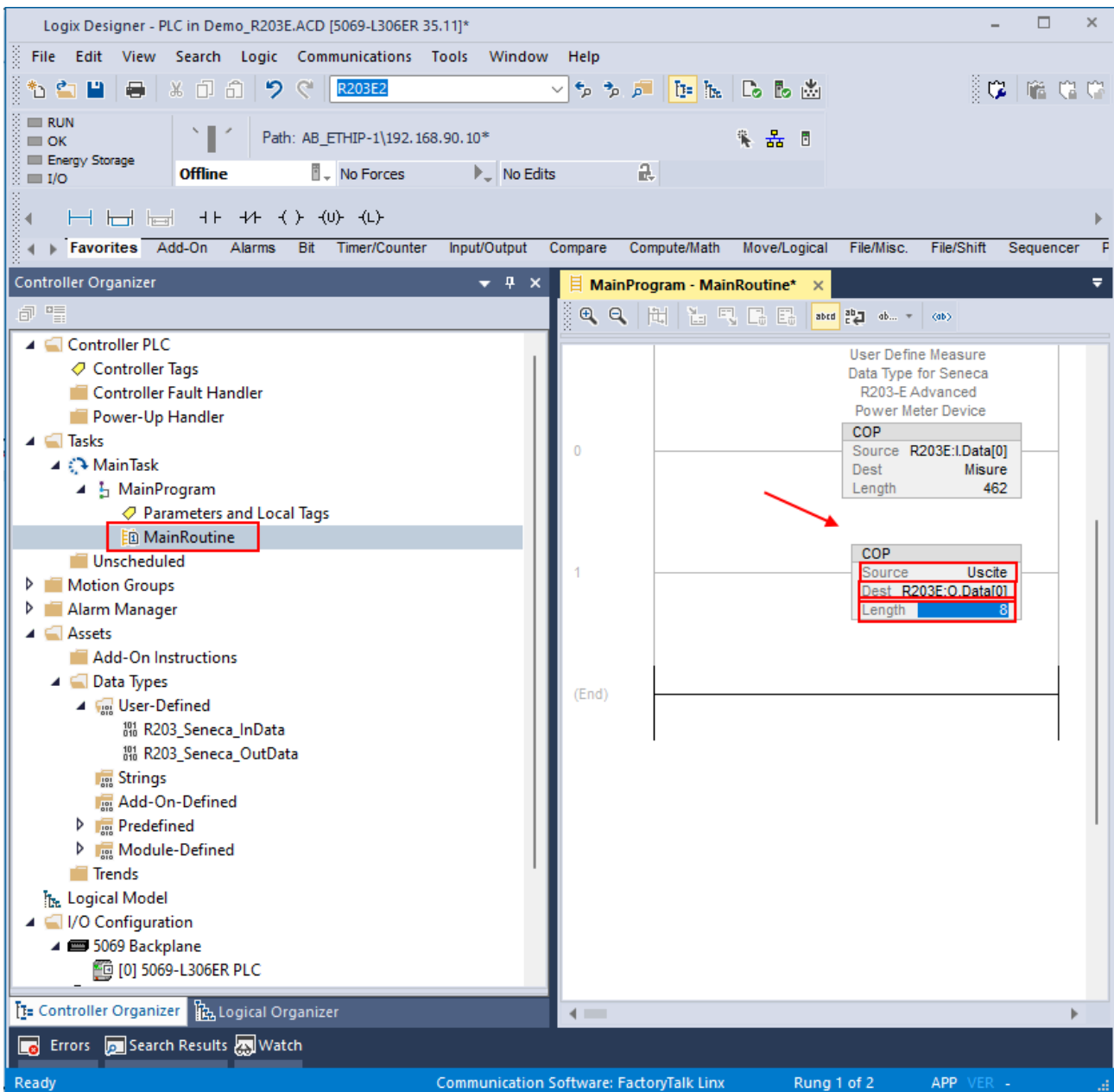

The screenshot shows the Logix Designer interface for a PLC project. The main window displays a ladder logic program with two rungs. The first rung (Rung 0) contains a COP instruction with the following properties:

User Define Measure	
Data Type for Seneca	
R203-E Advanced	
Power Meter Device	
COP	
Source	R203E:I.Data[0]
Dest	Misure
Length	462

The second rung (Rung 1) contains another COP instruction with the following properties:

COP	
Source	Uscite
Dest	R203E:O.Data[0]
Length	8

The Controller Organizer on the left shows the project structure, with the **MainRoutine** folder highlighted. The status bar at the bottom indicates the system is ready, running Rung 1 of 2.

Ora compiliamo, portiamo il PLC in modalità “Program” e facciamo il download del programma al PLC. Portiamo il PLC in modalità “RUN” e verifichiamo le misure:

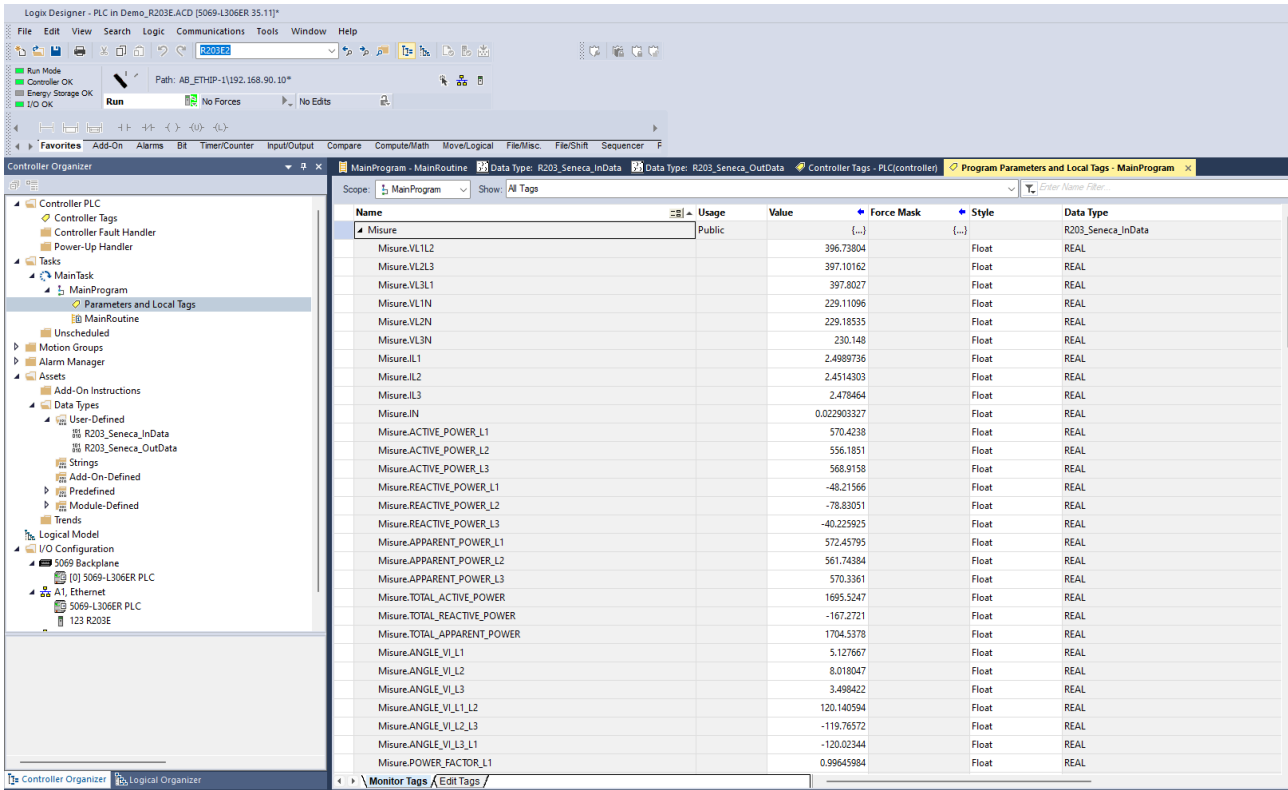

Name	Usage	Value	Force Mask	Style	Data Type
Misure.VL1L2	Public	396.73804	{...}	{...}	R203_Seneca_InData
Misure.VL2L3		397.10162			REAL
Misure.VL3L1		397.80227			REAL
Misure.VL1IN		229.11096			REAL
Misure.VL2N		229.18535			REAL
Misure.VL3N		230.148			REAL
Misure.I1		2.4989736			REAL
Misure.I2		2.4514303			REAL
Misure.I3		2.478464			REAL
Misure.IN		0.022903327			REAL
Misure.ACTIVE_POWER_L1		570.4238			REAL
Misure.ACTIVE_POWER_L2		556.1851			REAL
Misure.ACTIVE_POWER_L3		568.0158			REAL
Misure.REACTIVE_POWER_L1		-48.21566			REAL
Misure.REACTIVE_POWER_L2		-78.83051			REAL
Misure.REACTIVE_POWER_L3		-40.225925			REAL
Misure.APPARENT_POWER_L1		572.45795			REAL
Misure.APPARENT_POWER_L2		561.74384			REAL
Misure.APPARENT_POWER_L3		570.3361			REAL
Misure.TOTAL_ACTIVE_POWER		1695.5347			REAL
Misure.TOTAL_REACTIVE_POWER		-167.2721			REAL
Misure.TOTAL_APPARENT_POWER		1704.5378			REAL
Misure.ANGLE_VL1		5.127667			REAL
Misure.ANGLE_VL2		8.018047			REAL
Misure.ANGLE_VL3		3.498422			REAL
Misure.ANGLE_VL1_L2		120.140594			REAL
Misure.ANGLE_VL2_L3		-119.76572			REAL
Misure.ANGLE_VL3_L1		-120.02344			REAL
Misure.POWER_FACTOR_L1		0.99645984			REAL

Possiamo anche comandare le uscite digitali attivando ad esempio il DOUT1:

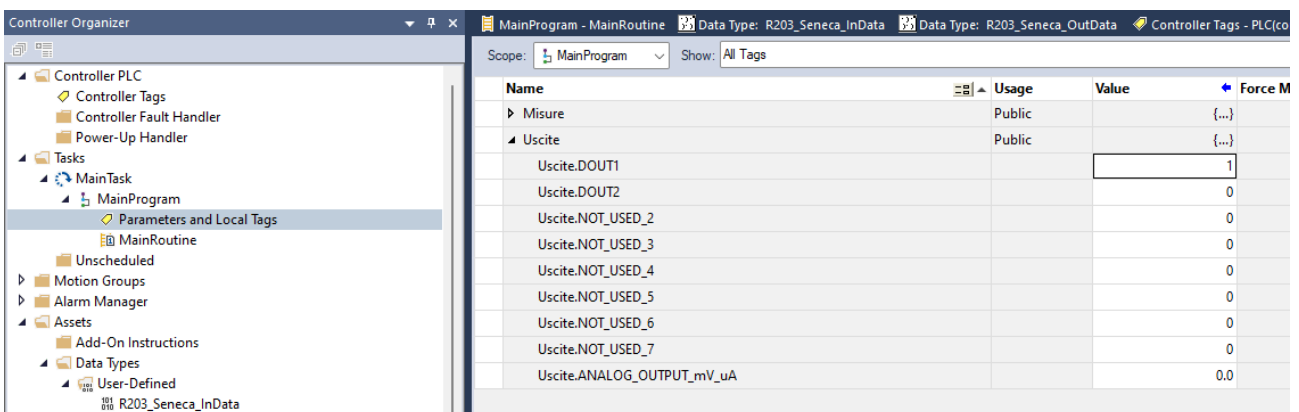

Name	Usage	Value	Force M
Misure	Public		{...}
Uscite	Public		{...}
Uscite.DOUT1		1	
Uscite.DOUT2		0	
Uscite.NOT_USED_2		0	
Uscite.NOT_USED_3		0	
Uscite.NOT_USED_4		0	
Uscite.NOT_USED_5		0	
Uscite.NOT_USED_6		0	
Uscite.NOT_USED_7		0	
Uscite.ANALOG_OUTPUT_mV_uA		0.0	