

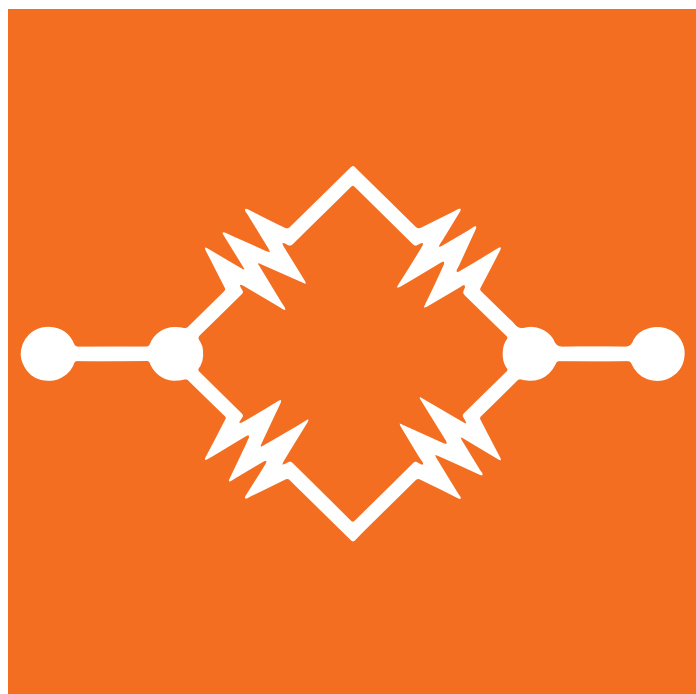

100% Made & Designed in Italy

STRAIN GAUGE WEIGHING I/O MODULES



STRAIN GAUGE WEIGHING I/O MODULES

OVERVIEW

Load Cells I/O Modules

Z-SG ZC-SG R-SG3 Z-SG3



ZE-SG3 ZE-SG3-P R-SG3-P



SENECA I/O modules for strain gauge load cells (strain gauges) can be integrated into all weighing systems in a flexible form. In addition to weight, force or tension gauges, "SG" modules allow data acquisition in stand-alone mode or interfaced with third-party systems. The devices provide multiple methods of calibration of the load cell connected directly from web server (TCP-IP Profinet models with or without dedicated software, with or without weight sample, with or without acquisition of factory parameters). The modules are available with the form factors Z (17,5 x 102,5 x 111 mm) and R (53,3 x 90 x 32 mm) depending on installation requirements. Measurement, made in 4- or 6-wire technique, is available via ModBUS RTU, ModBUS TCP-IP, CANopen Profinet IO communication protocols and mA/V analog output (where available).

SG modules directly power the strain gauge and provide primary features of robustness, safety and accuracy with galvanic isolation up to 1.500 Vac. The accuracy class is 0,01 with load cell sensitivity from 1 to 64 mV/V. Hot swapping allows its replacement without interrupting the continuity of the weighing system. Among the most advanced features are versatile management of the application (counting pieces, automatic tare reset, alarm threshold, automatically upgradable firmware) and fo measurement (integer value or floating point, stabilization by predictive algorithm and noise filter, configurable resolution and sampling rate). ModBUS models also support the Pass Through function that enables to divert requests from Modbus TCP-IP nodes to the RS485 serial line and behave as gateways. The SENECA solution for weighing systems includes an equalization system and connection of up to 4 load cells in parallel (SG-EQ 4) in addition to the availability of OLED (S401) LED (VISUAL Series) and IIoT (SSD) HMIs, radio modules and gateways for remote signal transmission.

Z (width 17 mm) or R (depth 32 mm) form factor

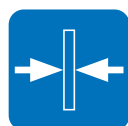

Predictive filter for measurement stabilization



Accuracy class 0,01%



Load cell high sensitivity from 1 to 64 mV/V



ModBUS RTU / TCP-IP, CANopen, Profinet IO integrated communication



Settable sampling frequency



Flexible configuration (DIP-switches, software, web server)



Advanced functions (tare acquisition, piece counter, threshold settable alarm)



Advanced connectivity (Peer-to-Peer, ModBUS Pass Through)



Flexible calibration methods of the load cell



4 / 6-wire technique load cell connection



Equalizer for parallel connections



CALIBRATION METHODS FOR LOAD CELL

Load cells are transducers that convert compressive, tensile, torsional, pressure or rotational forces into an electrical signal. They are used for measuring force and weight (from micrograms to tons). They usually generate an output signal analog that is amplified through special acquisition boards. SG modules allow flexible management of the calibration of the connected load cell, a precondition for proper operation of the weighing system.

Calibration tools and methods for Z-SG, ZC-SG, Z-SG3 models:



- DIP-switch+pulsante tara
- EASY SETUP
- EASY SETUP APP
- EASY SETUP2
- Nodo fieldbus
- Peso campione
- Parametri di fabbrica

Calibration method for R SG3, ZE SG3, ZE SG3 P, R SG3 P models:

- Web Server

For more details on calibration methods, please see the User Manual of the instruments.

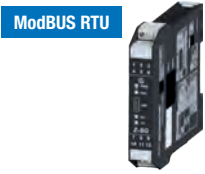
SENECA I/O RANGE FOR WEIGHING SYSTEMS

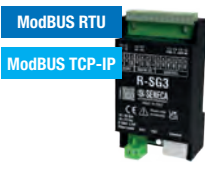



	Z-SG	ZC-SG	R-SG3
			
	ModBUS RTU strain gauge converter module with micro USB port	CANopen strain gauge converter module	ModBUS RTU/TCP-IP compact strain gauge module
GENERAL DATA			
Power supply	10..40 Vdc / 19..28 Vac	10..40 Vdc / 19..28 Vac	10..40 Vdc; 19..28 Vac
Power consumption	Typico: 1,5 W @ 24Vdc, Max: 2 W	Max 2 W	Max 1,5 W
Isolation	1,5 kVac	1.5 kVac (3-way)	1.5 kVac (3-way)
Connections	Power supply Error Data Transmission Data Reception	Power supply Communication Error Input	RX/TX RS485 Digital I/O Activation Power supply Load Cell Overload Calibration Transit Ethernet Connection
Protection degree	IP20	IP20	IP20
Operating temperature	-10..+65°C	-10..+65°C	-25..+65°C
Dimension	17,5 x 102,5 x 111 mm	17.5 x 102.5 x 111 mm	53.3 x 90 x 32.2 mm
Weight	Approx 110 g	Approx 170 g	Approx 80 g
Case	PA6, black color	Nylon 6 filled with 30% glass fiber, self-extinguishing class V0	Material PC / ABS self-extinguishing UL94-V0, color black
Connections	Removable screw terminals up to 2.5 mm ² conductors IDC10 rear connector for DIN rail 46277 Front micro USB	Removable 4-way screw terminals, 3.5 mm pitch IDC10 rear connector for DIN rail 3.5 mm stereo front jack for RS232 (COM)	Removable screw terminals 5 mm pitch
Mounting	IEC EN60715 35mm DIN rail in vertical position	IEC EN60715 35mm DIN rail in vertical position	On DIN EN 60715 rail, wall-mounted / panel-mounted
Approvals	CE	CE, CAN 2.0A, 2.0B CiA 401 v.2.01 IEC EN 61131-2	CE, UKCA
CONFIGURATION			
DIP Switch	x	x	x
Z-NET4	x	x	
EASY SETUP / EASY SETUP 2	x	x	
WEB SERVER			x
SoftPLC IEC 61131-2		x	
Advanced functions	Tare functions (Reset, Acquisition); Stable weighing signal	Tare functions (Reset, Acquisition); Stable weighing signal	Tare functions (Silos, Reset, Acquisition); Counting function; Stable weighing signal; Peer-To-Peer; Pass-Through
Advanced settings	Sampling frequency; Alarm threshold with hysteresis; Resolution	Sampling frequency; Alarm threshold with hysteresis; Resolution	Firmware upgradeable; Independent digital I/O; Sampling rate; Alarm threshold with hysteresis; Resolution
MEASUREMENTS			
24-bit ADC	Yes	Yes	Yes
Accuracy class	0,01%	0,01%	0,01%
Stability	0,025%/°C	0,025%/°C	0,025%/°C
Thermal drift	<25 ppm/°C	<25 ppm/°C	<25 ppm/°C
Integer value / floating point	(only weight)	(only weight)	Yes
Min/max net weight value	No	No	Yes
Stabilized measurement	Yes with moving average filter	Yes with moving average filter	Yes with noise filter and predictive filter
Ratiometric measurement	Yes	Yes	Yes
COMMUNICATION			
Interfaces	Nr.1 RS485 2-wire port Nr.1 RS232 (3.5 mm stereo jack) port	Nr. 1 CAN port Nr. 1 RS232 port	Nr.1 100 baseT Ethernet port on RJ45 Nr.1 RS485 port on terminals Nr.1 Micro USB (programming)
Speed	Up to 115,200 bps	Up to 1 Mbps (CANopen)	Up to 115,200 bps (RS485) / 100 Mbps (TCP-IP)
Protocols	ModBUS RTU	CANopen	ModBUS RTU, ModBUS TCP-IP
Communication time	< 10 ms (@38,400 bps)	20 ms	< 10 ms
INPUT/OUTPUT DATA			
Analog input up to 4 load cells in parallel	Nr.1 ANALOG INPUT 4- or 6-wire differential measurement. Input impedance: > 1 MΩ Full scale: ± 10 mV / ± 320 mV Error: 0.01% f.s. Thermal stability: 0.0025%/°C f.s. LOAD CELL Supply voltage: 5 Vdc Minimum impedance: 87 Ω equivalent Sensitivity: ±1 mV/V to ±64 mV/V	Nr.1 ANALOG INPUT 4- or 6-wire differential measurement. Input impedance: > 1 MΩ Full scale: ± 10 mV / ± 320 mV Error: 0.01% f.s. Thermal stability: 0.0025%/°C f.s. LOAD CELL Supply voltage: 5 Vdc Minimum impedance: 87 Ω equivalent Sensitivity: ±1 mV/V to ±64 mV/V	Nr.1 ANALOG INPUT 4- or 6-wire differential measurement. Input impedance: > 1 MΩ Full scale: ± 10 mV / ± 320 mV Error: 0.01% f.s. Thermal stability: 0.0025%/°C f.s. LOAD CELL Supply voltage: 5 Vdc Minimum impedance: 87 Ω equivalent Sensitivity: ±1 mV/V to ±64 mV/V
Trimming load cells	Yes	Yes	Yes
Analog output retransmitted (net weight)	Nr.1 ANALOG OUTPUT Voltage: Configurable between 0 - 10 Vdc, minimum load resistance 2 kΩ Current: Configurable between 0 - 20 mA, maximum load resistance 500 Ω Retransmission error: 0.1 % of maximum range Response time (10%..90%): 5 ms		
Digital Input/Output (tare calibration or weight threshold)	Nr.1 DIGITAL INPUT/OUTPUT. Opto-isolated Digital Input: Min voltage 12 V / Max voltage 30 V Opto-isolated Digital Output: Min. current 50 mA / Max voltage 30 V	Nr.1 DIGITAL INPUT/OUTPUT Opto-isolated Digital Input: Min voltage 12 V / Max voltage 30 V Opto-isolated Digital Output: Min. current 50 mA / Max voltage 30 V	Nr.2 DIGITAL INPUT/OUTPUT Opto-isolated Digital Input: Min voltage 12 V / Max voltage 30 V Opto-isolated Digital Output: Min. current 50 mA / Max voltage 30 V

Z-SG3

ZE-SG3

ZE-SG3-P

R-SG3-P

 <p>ModBUS RTU</p>	 <p>ModBUS RTU ModBUS TCP-IP</p>	 <p>PROFINET COMING SOON</p>	 <p>PROFINET COMING SOON</p>
ModBUS RTU advanced strain gauge converter module	ModBUS RTU/TCP-IP advanced strain gauge converter module	Profinet IO advanced strain gauge converter module	Profinet IO compact strain gauge converter module
10..40 Vdc / 19..28 Vac	10..40 Vdc / 19..28 Vac	10..40 Vdc / 19..28 Vac	10..40 Vdc; 19..28 Vac
Max 2 W	Max 2 W	Max 2 W	Max 1,5 W
1,5 kVac (5-way)	1,5 kVac (6-way)	1,5 kVac (6-way)	1.5 kVac (3-way)
RX/TX RS485 Digital I/O Activation Power supply Load Cell Overload	RX/TX RS485 Digital I/O Activation Power supply Load Cell Overload	Digital I/O activation Power supply Load cell overload	Digital I/O activation Power supply Load cell overload
IP20	IP20	IP20	IP20
-25..+70°C	-25..+70°C	-25..+70°C	-25..+65°C
17.5 x 102.5 x 111 mm	17.5 x 102.5 x 111 mm	17.5 x 102.5 x 111 mm	53.3 x 90 x 32.2 mm
Approx 110 g	Approx 110 g	Approx 110 g	Approx 80 g
PA6, color black	PA6, black color	PA6, black color	Material PC / ABS self-extinguishing UL94-V0, color black
Removable 3-way screw terminals, 5 mm pitch IDC10 rear connector for DIN rail 46277 Micro USB front	Removable 3-way screw terminals, 5 mm pitch IDC10 rear connector for DIN rail 46277 -	Removable 3-way screw terminals, 5 mm pitch IDC10 rear connector for DIN rail 46277	Removable screw terminals 5 mm pitch
IEC EN60715 35mm DIN rail in vertical position	IEC EN60715 35mm DIN rail in vertical position	IEC EN60715 35mm DIN rail in vertical position	On DIN EN 60715 rail, wall-mounted / panel-mounted
CE, UKCA	CE, UKCA	CE, UKCA	CE, UKCA
x	x	x	x
x	x	x	x
Tare functions (Silos, Reset, Acquisition); Counting function; Stable weighing report; Peer-To-Peer; Pass-Through Firmware upgradeable; Independent digital I/O; Sampling rate; Alarm threshold with hysteresis; Resolution	Tare functions (Silos, Reset, Acquisition); Counting function; Stable weighing report; Peer-To-Peer; Pass-Through Firmware upgradeable; Independent digital I/O; Sampling rate; Alarm threshold with hysteresis; Resolution	Tare functions (Silos, Reset, Acquisition); Counting function; Peer-To-Peer; Pass-Through Firmware upgradeable; Independent digital I/O; Sampling rate; Alarm threshold with hysteresis; Resolution	Tare functions (Silos, Reset, Acquisition); Counting function; Peer-To-Peer; Pass-Through Firmware upgradeable; Independent digital I/O; Sampling rate; Alarm threshold with hysteresis; Resolution
Yes	Yes	Yes	Yes
0,01%	0,01%	0,01%	0,01%
0,025%/°C	0,025%/°C	0,025%/°C	0,025%/°C
<25 ppm/°C	<25 ppm/°C	<25 ppm/°C	<25 ppm/°C
Yes	Yes	Yes	Yes
Yes	Yes	Yes	Yes
Si con filtro antirumore predittivo	Yes with noise filter and predictive filter	Yes with noise filter and predictive filter	Yes with noise filter and predictive filter
Yes	Yes	Yes	Yes
Nr.1 RS485 port on terminals / IDC10 Nr.1 Micro USB (programming)	Nr.1 Ethernet port 100 baseT on RJ45 (with fault-bypass LAN function) Nr.1 RS485 port on terminals / IDC 10	Nr.1 Ethernet port (with fault-bypass LAN function) 100 baseT on RJ45	Nr.1 Ethernet port (with fault-bypass LAN function) 100 baseT on RJ45
Up to 115,200 bps (RS485)	Up to 115,200 bps (RS485) / 100 Mbps (TCP-IP)		
ModBUS RTU	ModBUS RTU, ModBUS TCP-IP	Profinet IO	Profinet IO
< 10 ms	< 10 ms	n.a.	n.a.
Nr.1 ANALOG INPUT 4- or 6-wire differential measurement. Input impedance: > 1 MΩ Full scale: ± 10 mV / ± 320 mV Error: 0.01% f.s. Thermal stability: 0.0025%/°C f.s. LOAD CELL Supply voltage: 5 Vdc Minimum impedance: 87 Ω equivalent Sensitivity: ±1 mV/V to ±64 mV/V Yes	Nr.1 ANALOG INPUT 4- or 6-wire differential measurement. Input impedance: > 1 MΩ Full scale: ± 10 mV / ± 320 mV Error: 0.01% f.s. Thermal stability: 0.0025%/°C f.s. LOAD CELL Supply voltage: 5 Vdc Minimum impedance: 87 Ω equivalent Sensitivity: ±1 mV/V to ±64 mV/V Yes	Nr.1 ANALOG INPUT 4- or 6-wire differential measurement. Input impedance: > 1 MΩ Full scale: ± 10 mV / ± 320 mV Error: 0.01% f.s. Thermal stability: 0.0025%/°C f.s. LOAD CELL Supply voltage: 5 Vdc Minimum impedance: 87 Ω equivalent Sensitivity: ±1 mV/V to ±64 mV/V Yes	Nr.1 ANALOG INPUT 4- or 6-wire differential measurement. Input impedance: > 1 MΩ Full scale: ± 10 mV / ± 320 mV Error: 0.01% f.s. Thermal stability: 0.0025%/°C f.s. LOAD CELL Supply voltage: 5 Vdc Minimum impedance: 87 Ω equivalent Sensitivity: ±1 mV/V to ±64 mV/V Yes
Nr.1 ANALOG OUTPUT Voltage: Configurable between 0 - 10 Vdc, minimum load resistance 2 kΩ Current: Configurable between 0 - 20 mA, maximum load resistance 500 Ω Retransmission error: 0.1 % of maximum range Response time (10%..90%): 5 ms	Nr.1 ANALOG OUTPUT Voltage: Configurable between 0 - 10 Vdc, minimum load resistance 2 kΩ Current: Configurable between 0 - 20 mA, maximum load resistance 500 Ω Retransmission error: 0.1 % of maximum range Response time (10%..90%): 5 ms		
Nr.2 DIGITAL INPUT/OUTPUT Opto-isolated Digital Input: Min voltage 12 V / Max voltage 30 V Opto-isolated Digital Output: Min. current 50 mA / Max voltage 30 V	Nr.2 DIGITAL INPUT/OUTPUT Opto-isolated Digital Input: Min voltage 12 V / Max voltage 30 V Opto-isolated Digital Output: Min. current 50 mA / Max voltage 30 V	Nr.2 DIGITAL INPUT/OUTPUT Opto-isolated Digital Input: Min voltage 12 V / Max voltage 30 V Opto-isolated Digital Output: Min. current 50 mA / Max voltage 30 V	Nr.2 DIGITAL INPUT/OUTPUT. Opto-isolated Digital Input: Min voltage 12 V / Max voltage 30 V Opto-isolated Digital Output: Min. current 50 mA / Max voltage 30 V

STRAIN GAUGE WEIGHING I/O MODULES

APPLICATION SCHEMES

WEIGHING SYSTEM WITH CONVEYOR BELT

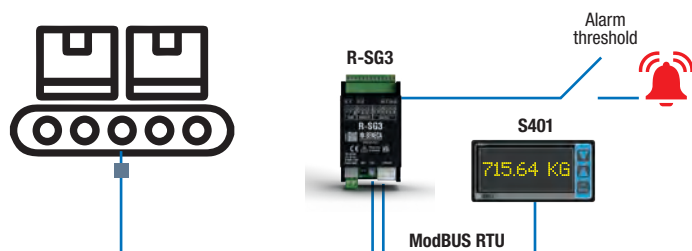

MEASUREMENT AND RETRANSMISSION WEIGHT WITH LOAD CELLS IN PARALLEL

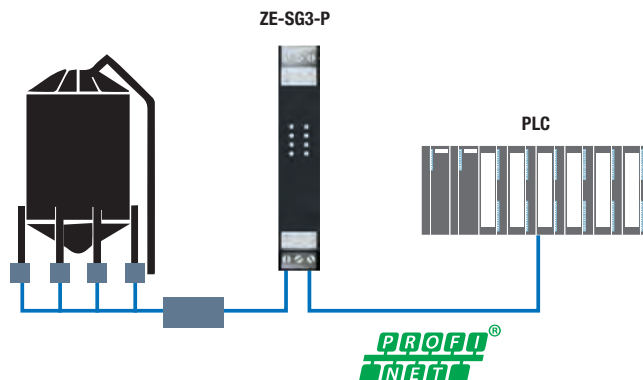

WEIGHING SYSTEM CALIBRATION

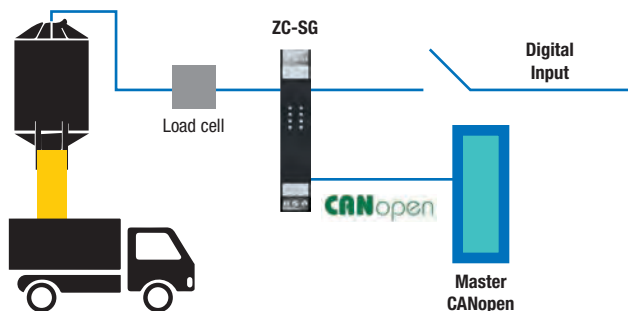

LOAD CELL MEASUREMENT IN PARALLEL AND RETRANSMISSION IN SERIES

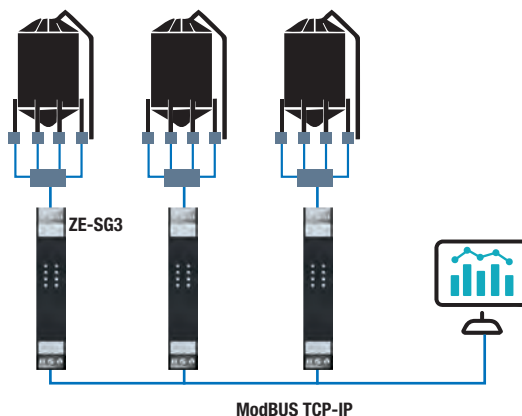

VISUALIZATION OF VALUES OF WEIGHT AND FORCE

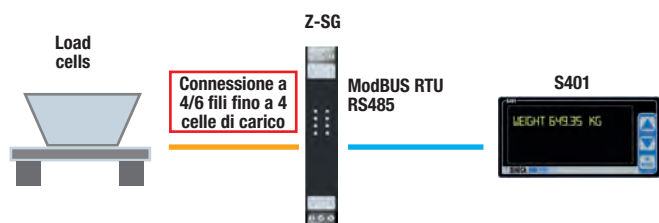

VISUALIZATION AND ALARM MANAGEMENT OF WEIGHT AND FORCE VALUES

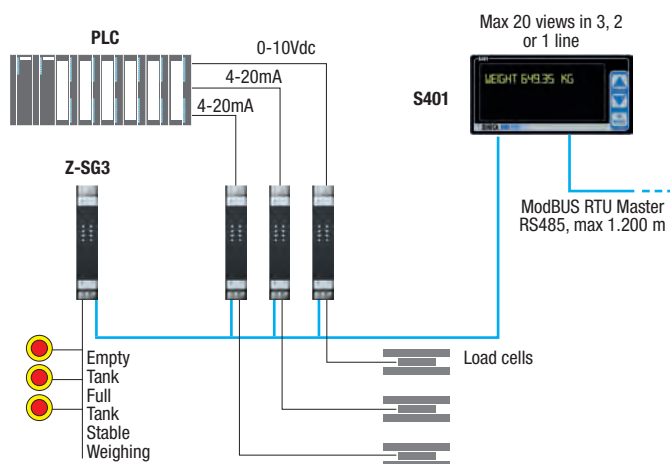

STRAIN GAUGE WEIGHING I/O MODULES

ACCESSORIES AND SUPPLY COMPLEMENTS

SG-EQ4 Equalizer

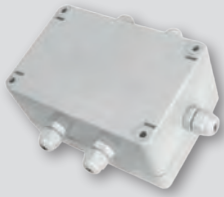

SG-EQ4 is a junction-box / equalizer for connecting multiple load cells to weighing systems. The load cells must be electrically connected in such a way that the signal lines (output), excitation (power supply) and sense (when present) are in parallel.

S401 Oled Indicator



S401-L is an industrial indicator with display. OLED (Organic Light Emitting Diode) with dual RS485 ModBUS serial port. It enables the display of up to 30 measurements (20 direct, 10 calculated) and the alarm management on threshold or event.

CONTROL UNITS



SENeca multifunction controllers are modular/all-in-one high connectivity devices. They combine PLC tasks based on the Straton IEC 61131-3 softPLC platform with web server, datalogger, remote control, remote service and energy management features.

GATEWAYS



SENeca gateways connect new and legacy systems, facilitating a secure and uninterrupted flow between peripheral devices and servers/centralized servers. The devices establish a two-way communication between the field and the supervision, ensure networking functions and data processing.

SSD IIoT HMI



SURPRISE Smart Display is an operator terminal 7" touch of the latest generation with dual port fast ethernet, 802.11 b/g/n wi-fi module and function sniffer for serial lines. It is a multipurpose with IIoT gateway functionality, datalogger, Wi-Fi router, microcontroller, unit for remote assistance and remote control.

RADIO MODULES



For the radio transmission of SENeca's signals adopts UHF, VHF and LoRA technologies with coverage varying from a few hundred meters to several kilometers. Radio modules perform, among others, remote control and diagnostic functions through point-to-point, multipoint, broadcasting connections, signal repetitions.

APPLICATION FIELDS

LOAD CELL MANUFACTURERS

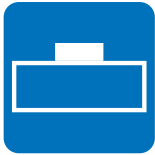

LABORATORIES

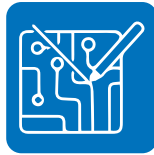

BUILDING CONSTRUCTION



FOOD INDUSTRY

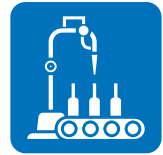

SCALES MANUFACTURERS

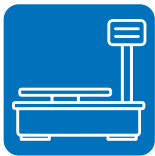

TRANSPORTATION



LOGISTICS AND WAREHOUSES



ROBOTICS AND BENCHES ASSEMBLY



ORDER CODES

Code	Description
STRAIN GAUGE MODULES	
R-SG3	Modbus TCP-IP / Modbus RTU compact strain gauge module
R-SG3-P	Profinet IO compact strain gauge module
ZC-SG	CANopen strain gauge converter module
ZE-SG3	ModBUS RTU / TCP-IP advanced strain gauge converter module
ZE-SG3-P	Profinet IO advanced strain gauge module
Z-SG	ModBUS RTU strain gauge converter module
Z-SG3	ModBUS RTU advanced strain gauge converter module
ACCESSORIES	
SG-EQ4	Equalization board up to 4 load cells
SG-EQ4-BOXPG7	Board + equalization box up to 4 load cells

ORDER CODES

Code	Description
SOFTWARE	
EASY SETUP / EASY SETUP 2	Plug&play programmable instruments configurator
Z-NET4	Automation systems configuration and engineering environment
HMI	
S401	2.7" OLED indicator with ModBUS interface
SSD	
https://www.seneca.it/en/linee-di-prodotto/acquisizione-dati-e-automazione/hmi-display/iiot/surprise-smart-display	
CONTROL UNITS	
https://www.seneca.it/linee-di-prodotto/acquisizione-dati-e-automazione/cpu-multifunzione-iec-61131/	
RADIO MODULES	
https://www.seneca.it/en/linee-di-prodotto/comunicazione-industriale-e-telecontrollo/moduli-radio/	



Headquarters:

Via Austria, 26 - 35127 Padova (I)
T. +39 049 8705.359 - F. +39 049 8706.287
info@seneca.it - www.seneca.it